

**Table of Contents**

<b>Section Code</b>	<b>Section</b>	<b>Page Number</b>	<b>Section Code</b>	<b>Section</b>	<b>Page Number</b>
1	Important Safety Instructions	2	28	Replace the Rocker Switch (On/Off)	147
1	Safety Warning Labels and Serial Number	3	29	Replace the Side Rail	151
1	Specifications	4	30	Replace the Speed Sensor Assembly	155
1	Grounding Instructions	5	31	Replace the Transport Wheel	160
1	Emergency Stop Procedure	5	32	Replace the Walking Belt	163
1	Moving and Storing the Machine	6	33	Service or Replace the Walking Deck	173
1	Unfolding the Machine	8			
1	Leveling the Machine	9			
1	Treadmill Belt (break in period)	9			
1	Connectivity	10			
1	Maintenance	11			
1	Cleaning	11			
1	Adjusting the Belt Tension	12			
1	Aligning the Walking Belt	12			
1	Lubricating the Walking Belt	13			
1	Heart Rate Chest Strap Battery Replacement	14			
1	Maintenance Parts	15			
1	Troubleshooting	17			
1	Machine Settings Mode	29			
1	Engineering Mode	30			
1	Electrical Wiring Diagram	31			
1	Demonstration Mode	32			
1	Replacement Procedure Skill Level	32			
	<b>Mechanical / Modification Procedures</b>				
2	Demonstration Mode	33			
3	Adjust the Deck Release Assembly	34			
4	Adjust the Walking Belt	38			
5	Correct the Clunking Noise	40			
	<b>Part Replacement</b>				
6	Replace the Bottom Motor Cover	45			
7	Replace the Circuit Breaker	49			
8	Replace the Console Assembly	53			
9	Replace the Deck Release Assembly	56			
10	Replace the Deck Suspension	62			
11	Replace the Deck Wheel	66			
12	Replace the Drive Belt	70			
13	Replace the Front Roller	75			
14	Replace the Incline Motor Assembly	81			
15	Replace the Lift Shock Assembly	87			
16	Replace the Lower I/O Cable	91			
17	Replace the Lower Side Rail	99			
18	Replace the Middle I/O Cable	103			
19	Replace the Motor	108			
20	Replace the Motor Control Board (MCB)	115			
21	Replace the Motor Control Board Cover	120			
22	Replace the Motor Cover	123			
23	Replace the Motor Mount	126			
24	Replace the Power Inlet	131			
25	Replace the Rear Roller	135			
26	Replace the Rear Roller Cover	140			
27	Replace the Right Upright	143			

**NOTICE:** This document provides important safety instructions, adjustments, and general troubleshooting information for the maintenance of the Bowflex® BXT116 Treadmill.

**If you need assistance, please call Nautilus Customer Service at 1-800-605-3369.**

 **This icon means a potentially hazardous situation which, if not avoided, could result in death or serious injury. Read and understand all Warnings on this machine.**

Nautilus, Inc., www.NautilusInc.com - Customer Service: North America (800) 605-3369, csnls@nautilus.com | outside U.S. www.nautilusinternational.com | Printed in China | © 2017 Nautilus, Inc. | ® indicates trademarks registered in the United States. These marks may be registered in other nations or otherwise protected by common law. Bowflex, the B logo, Bowflex Results Series, and Bowflex Connect are trademarks owned by or licensed to Nautilus, Inc. Polar®, OwnCode®, iTunes®, Google™, MyFitnessPal®, Under Armour, WD-40®, and Lube-N-Walk® are trademarks of their respective owners. The Bluetooth® word mark and logos are registered trademarks owned by Bluetooth SIG, Inc., and any use of such marks by Nautilus, Inc. is under license.

## Important Safety Instructions

 **This icon means a potentially hazardous situation which, if not avoided, could result in death or serious injury. Read and understand all Warnings on this machine.**

**Before servicing or using this equipment, obey the following warnings:**

 **Read and understand the Service Manual before working on the machine. Failure to obey the instructions and safety warnings could cause injury to the service technician or bystanders.**

**DANGER** To reduce the risk of electrical shock or unsupervised usage of the equipment, always unplug the power cord from the wall outlet and/or the machine and wait 5 minutes before cleaning, maintaining or repairing the machine. Place the power cord in a secure location.

- Keep bystanders and children away from the product being serviced at all times.
- Make sure that the repair is done in an appropriate work space away from foot traffic and exposure to bystanders.
- Some components of the equipment can be heavy or awkward. Enlist the service of a second person when you do maintenance steps involving these components. Do not try to do heavy or awkward steps on your own.
- Use only replacement parts and hardware that are supplied or approved by Nautilus. Failure to use Nautilus-approved replacement parts can adversely affect the safety and functionality of the equipment creating a risk to users and will void the warranty.
- Be sure that all warning stickers and instructional placards applied to the product stay present and in good condition when doing maintenance or replacing components. If necessary, request replacement warning stickers or placards from Nautilus customer service.
- Do not try to change the design or functionality of the machine being serviced as this can adversely affect user safety and will void the warranty.
- Do not put the machine back in service until all shrouds, instructions, warning labels and correct functionality have been verified and tested for correct performance.

# SAFETY WARNING LABELS AND SERIAL NUMBER

## CAUTION

Risk of Injury to Persons - To Avoid injury, use extreme caution when stepping onto or off of a moving belt. Read instruction manual before using.

## WARNING!

- Injury or death is possible if caution is not used while using this machine.
- Keep children and pets away.
- Read and follow all warnings on this machine.
- Refer to the Owner's Manual for additional warnings and safety information.
- The heart rate displayed is an approximation and should be used for reference only.
- Not intended for use by anyone under 14 years of age.
- The maximum user weight for this machine is 375 lbs (170 kg.)
- This machine is for home use only.
- Consult a physician prior to using any exercise equipment.



## WARNING!

HAZARDOUS VOLTAGE.

- Contact may cause electrical shock or burn.
- Turn off and lock out power before servicing.



## WARNING!

- Moving parts can crush and cut.
- Keep guards in place.
- Lock out power before servicing.

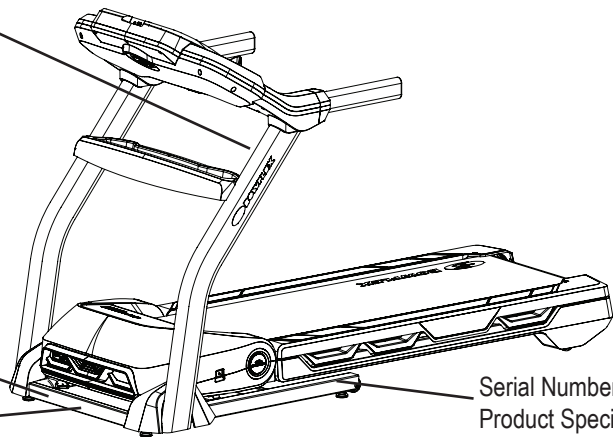

Serial Number and Product Specification

# SPECIFICATIONS

Maximum User Weight: 375 lbs. (170 kg)

Maximum Inclined Deck Height: 16 inches (40.6 cm)  
Machine Weight: approx. 280 lbs (127 kg)

Power Requirements:  
Operational Voltage: 120V AC @60Hz  
Operating Current: 15 A  
Heart Rate Chest Strap: 1 CR2032 battery

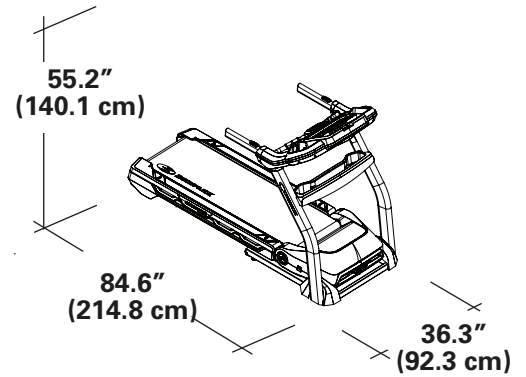

## **⚠ WARNING**

This product, its packaging, and components contain chemicals known to the State of California to cause cancer, birth defects, or reproductive harm. This Notice is provided in accordance with California's Proposition 65. If you would like additional information, please refer to our web site at [www.nautilus.com/prop65](http://www.nautilus.com/prop65).

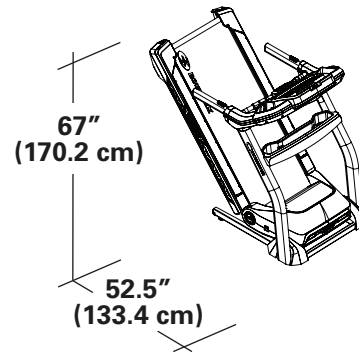

## Grounding Instructions

This product must be grounded. If it should malfunction or break down, grounding provides a path of least resistance for electric current to reduce the risk of electric shock. This product is equipped with a cord having an equipment-grounding conductor and a grounding plug. The plug must be plugged into an appropriate outlet that is properly installed and grounded in accordance with all local codes and ordinances.

**⚠ DANGER** Improper connection of the equipment-grounding conductor can result in a risk of electric shock. Check with a qualified electrician or service person if you are in doubt as to whether the product is properly grounded. Do not modify the plug provided with the product – if it will not fit the outlet, have a proper outlet installed by a qualified electrician.

If you connect the machine to an outlet with GFI (ground fault interrupt) or AFI (arc fault interrupt), machine operation can cause the circuit to trip.

**⚠** This machine is for use on a nominal 120-V circuit, and has a grounding plug that looks like the plug illustrated below. A temporary adapter that looks like the adapter illustrated may be used to connect this plug to a 2-pole receptacle as shown if a properly grounded outlet is not available.

The temporary adapter should be used only until a properly grounded outlet can be installed by a qualified electrician. The tab for the grounding screw must be connected to a permanent ground such as a properly grounded outlet box cover. Whenever the adapter is used, it must be held in place by a metal screw.

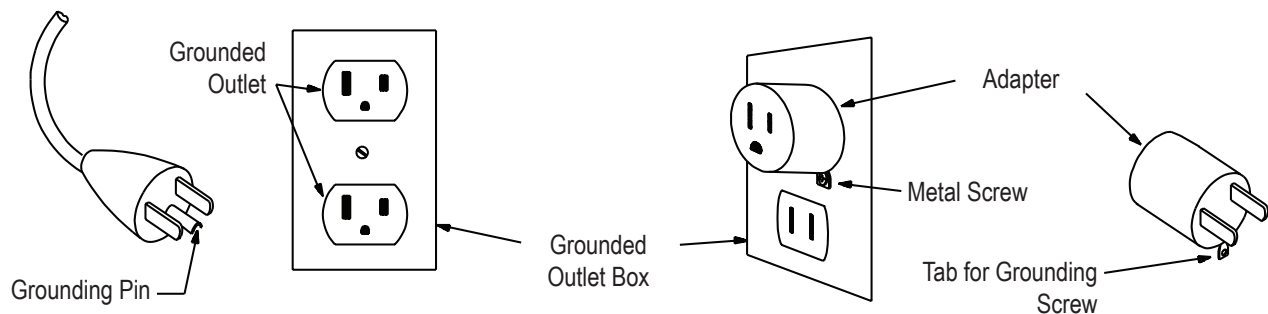

## Emergency Stop Procedure

The Treadmill machine is equipped with a Safety Key that can prevent serious injury, as well as prevent children from playing with and/or being injured on the machine. If the Safety Key is not correctly inserted into the Safety Key Port, the belt will not operate.

**⚠** Always attach the Safety Key Clip to your clothing during your workout.

When you use the machine, only remove the Safety Key in an emergency. When the key is removed while the machine is in operation, it will stop quickly, which could cause the loss of balance and possible injury.

For safe storage of the machine, and to prevent unsupervised operation of the machine, always remove the Safety Key and disconnect the power cord from the wall outlet and the AC input. Place the power cord in a secure location.

The Console will display “ + SAFETY KEY ”, or add Safety Key, for a Safety Key fault. The Treadmill machine will not start a Workout, or will end and clear an active Workout, when the Safety Key is removed. Inspect the Safety Key and be sure it is connected to the Console correctly.

## Moving and Storing the Machine

**!** The machine can be moved by one or more persons. Use caution when you move the machine. The treadmill is heavy and can be awkward. Make sure that your own physical strength is capable of moving the machine. Use a second person if necessary.

1. Before the machine can be moved, inspect the Walking Deck to be sure the Incline setting is at "0". If necessary, adjust the Incline setting to "0".

**!** Be sure the area below the machine is clear before adjusting the incline of the Deck. Fully lower the incline of the Deck after each workout.

2. Remove the Safety Key and place it in a secure location.

**!** When this machine is not in operation, remove the Safety Key and keep out of the reach of children.

3. Make sure that the power switch is turned Off, and the power cord is disconnected.

4. You must fold the treadmill before you move it. Never move the treadmill if it is not folded.

**!** Never move the machine with the Walking Deck not folded. Rotating or moving parts can pinch, resulting in personal injury.

5. Make sure that there is safe clearance around, on and above your treadmill. Make sure there is no object to spill or cause blockage from the fully folded position.

**!** Be sure there is adequate height clearance for the raised deck.

6. With your right hand, push and hold down the Walking Deck Release Button. Using the lifting handle found below the rear of the walking belt, lift the walking deck fully upward and engage the hydraulic lift. The Walking Deck Release Button can be released when the walking deck has moved about 10 inches (25.4 cm). Be sure that the hydraulic lift is correctly locked in place.

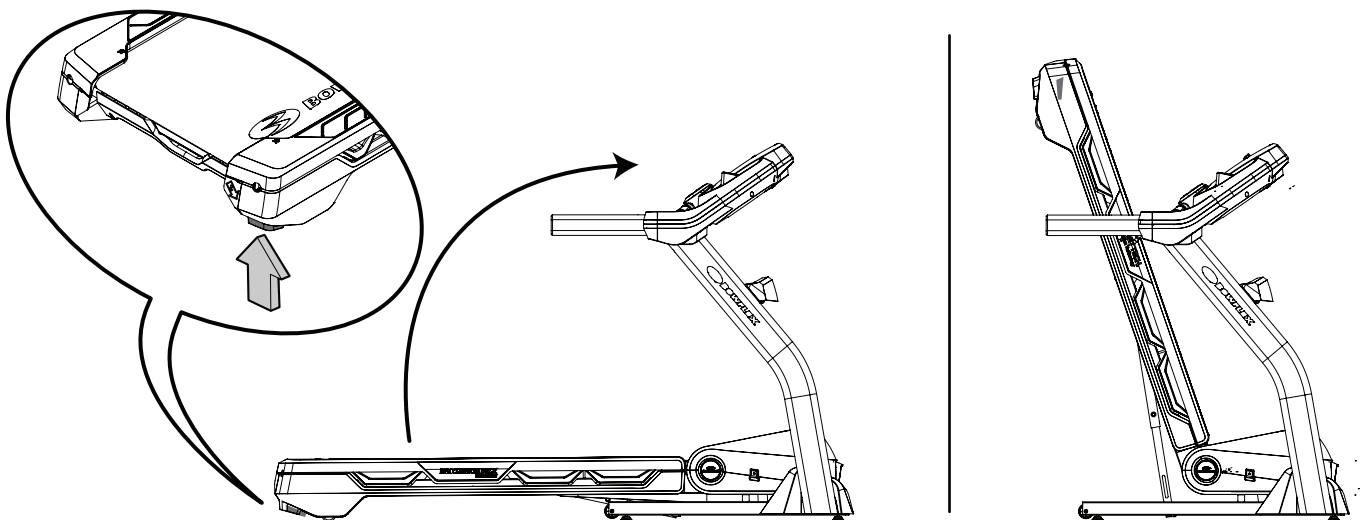

 Use proper safety precautions and lifting techniques. Bend your knees and elbows, keep your back straight and pull up equally with both arms. Straighten your legs to lift. Make sure that your own physical strength is capable of lifting the walking deck until it engages the locking mechanism. Use a second person if necessary.

**Do not use the walking belt or rear roller to lift the treadmill. These parts do not lock in place and can abruptly move. Injury to you or damage to the machine can occur.**

7. Make sure that the locking mechanism is engaged. Carefully pull back on the walking deck and make sure that it does not move. When you do this, keep clear of movement path in case the treadmill lock is not properly engaged.

 **Do not lean against the treadmill when it is folded. Do not put items on it that could cause it to become unstable or fall.**

**Do not connect the power cord or try to operate the treadmill in the folded position.**

8. Carefully tilt the base frame of the folded treadmill a small distance back on the transport wheels while grasping the front support bar.

 **Do not use the Console, handlebars, or lifted walking deck to lift or move the treadmill. Damage to the treadmill can occur.**

**Keep clear of the movement path of the lifted walking deck.**

9. Roll the machine on the transport wheels to its new location.

 **Place the machine on a clean, hard, level surface, free from unwanted material or other objects that may hamper your ability to move freely. A rubber mat should be used below the machine to prevent the release of static electricity and protect your flooring.**

**Do not put objects in the path of the walking deck when lowered.**

*NOTICE:* Move the machine carefully so that it does not hit other objects. This can damage the Console operation.

10. Prior to use, refer to the “Unfolding the Machine” procedure in this manual.

## Unfolding the Machine

1. Make sure there is sufficient space to lower the walking deck.

**!** Keep a minimum clearance behind the machine of 79" (2 m) and 24" (0.6 m) on each side. This is the recommended safe distance for access, movement and emergency dismounts from the machine.

Place the machine on a clean, hard, level surface, free from unwanted material or other objects that may hamper your ability to move freely with a sufficient clear workout area. A rubber mat below the machine is recommended to prevent electrostatic discharge and protect your floor.

Be sure that the workout space you are utilizing has adequate height clearance, taking into consideration the height of the user and the maximum incline of the deck.

2. Make sure there is no object on or around the treadmill to spill or cause blockage from the fully unfolded position.

3. Slightly push the walking deck toward the console. With your right hand, push and hold down the Walking Deck Release Button and pull the walking deck away from the console. Once the end of the walking deck has moved about 10 inches (25.4 cm), release the button and move to the side of the machine. Continue to pull the walking deck.

**!** Keep clear of the movement path of the walking deck.

4. The hydraulic lift is set up to drop lightly. Hold onto the walking deck until approximately 2/3 of the movement down. Make sure that you use proper lifting technique; bend your knees and keep your back straight. Lower the weight with your legs. The walking deck can possibly drop quickly in the last part of the movement.

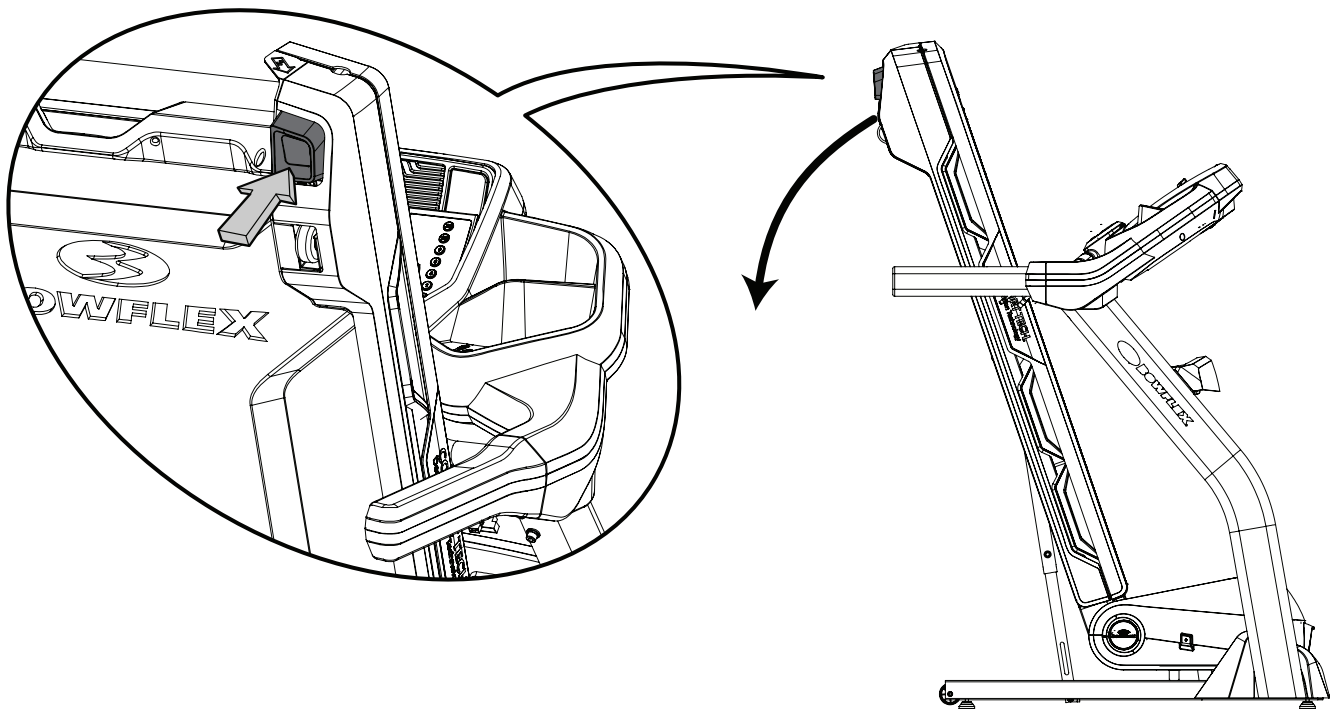



## Leveling the Machine

The machine needs to be leveled if your workout area is uneven. To adjust:

1. Place the machine in your workout area.
2. Adjust the levelers until they all contact the floor.

**⚠ Do not adjust the levelers to such a height that they detach or unscrew from the machine. Injury to you or damage to the machine can occur.**

3. Adjust until the machine is level.

Make sure the machine is level and stable before you exercise.

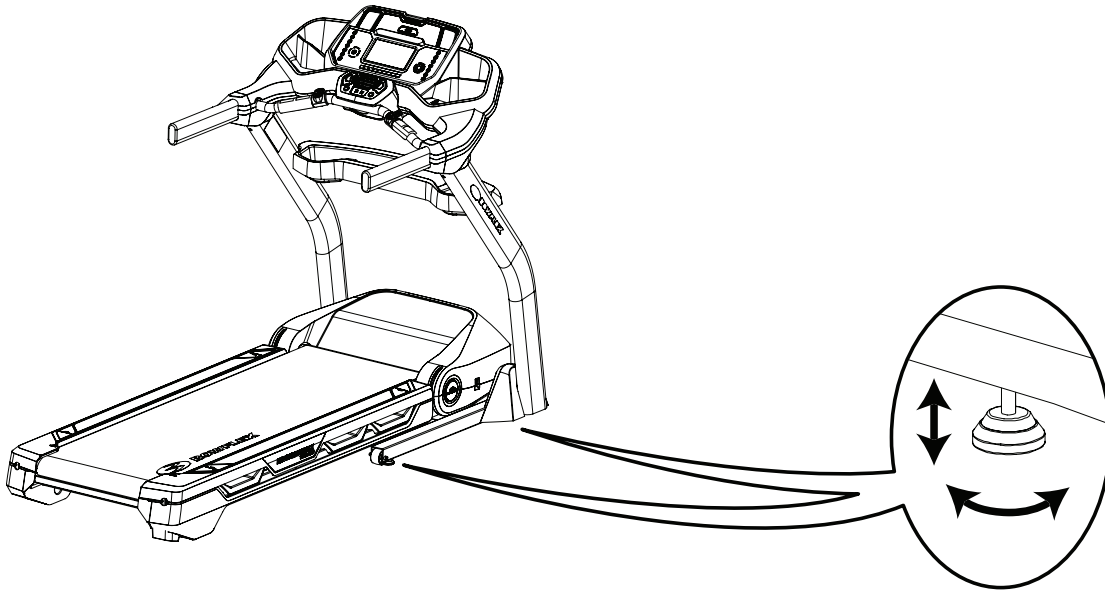

## Treadmill Belt

Your treadmill comes equipped with a durable, high quality walking belt designed to provide many hours of reliable service. The walking belt on a treadmill that has not been operated for a length of time, either in factory packaging or after assembly, can exhibit a “thumping” noise when started. This is due to the belt taking on the curve of the front and rear rollers. This is a common occurrence and does not indicate a problem with your machine. After the treadmill has been used for a short period of time the thumping noise will discontinue. The amount of time will vary depending on the temperature and humidity of the environment where the treadmill is placed.

## CONNECTIVITY

### Bluetooth® Connectivity with the “Bowflex Results Series™” Fitness App

This fitness machine is equipped with Bluetooth® connectivity and can wirelessly sync with the “Bowflex Results Series™” Fitness App on supported devices. The Software App syncs with your fitness machine to track total calories burned, time, distance, and more. It records and stores every workout for quick reference. Plus, it automatically syncs your workout data with MyFitnessPal®, and Under Armour® Connected Fitness to make hitting your daily calorie goal easier than ever! Track your results and share with friends and family.

1. Download the free Software App, named Bowflex Results Series™. The software app is available on iTunes® and Google Play™.

**Note:** For a complete list of supported devices, review the software app on iTunes® or Google Play™.

2. Follow the instructions on the Software App to sync your device to your exercise machine.
3. To sync your workout data with MyFitnessPal® or Under Armour® Connected Fitness, click on the desired program and login with your information.

**Note:** The “Bowflex Results Series™” Fitness App will automatically sync your workouts after the initial syncing.

### USB Charging

If a USB Device is attached to the USB Port, the Port will attempt to charge the Device. The power supplied from the USB Port may not be enough to operate the Device and charge it at the same time.

Read all maintenance instructions fully before you start any repair work. In some conditions, an assistant is required to do the necessary tasks.

**!** Equipment must be regularly examined for damage and repairs. The owner is responsible to make sure that regular maintenance is done. Worn or damaged components must be repaired or replaced immediately. Only manufacturer supplied components can be used to maintain and repair the equipment.

If at any time the Warning labels become loose, unreadable or dislodged, contact Nautilus Customer Service for replacement labels.

**DANGER** To reduce the risk of electrical shock or unsupervised usage of the equipment, always unplug the power cord from the wall outlet and the machine and wait 5 minutes before cleaning, maintaining or repairing the machine. Place the power cord in a secure location.

**Daily:** Before each use, examine the exercise machine for loose, broken, damaged, or worn parts. Do not use if found in this condition. Repair or replace all parts at the first sign of wear or damage, except for the Walking Deck. The Walking Deck is designed for wear on both sides of it. If only one side of the Walking Deck is worn, a replacement Deck is not required. It is recommended that a qualified service technician is used to flip the Walking Deck. After each workout, use a damp cloth to wipe your machine and Console free of moisture.

**Note:** Avoid excessive moisture on the Console.

**Weekly:** Check for smooth roller operation. Wipe the machine to remove dust, dirt, or grime.

**!** Do not remove the Motor Control Board (MCB) Cover, as dangerous voltages and moving parts are present. The components are serviceable only by approved service personnel or by following service procedures supplied by Nautilus, Inc.

**Note:** Do not use petroleum based products.

**Monthly or after 20 hours:** Make sure all bolts and screws are tight. Tighten as necessary.

**Quarterly:** Or after 25 hours—Lubricate the walking belt with a 100% pure silicone lubricant.

**!** Silicone lubricant is not intended for human consumption. Keep out of reach of children. Store in a safe place.

**Note:** Do not use petroleum based products.

## Cleaning

**DANGER** To reduce the risk of electrical shock, always unplug the power cord and wait 5 minutes before cleaning, maintaining or repairing this machine.

Wipe the treadmill down after each use to keep the treadmill clean and dry. It may be necessary to use a mild dish soap at times to remove all dirt and salt from the belt, painted parts and the display.

**NOTICE:** If necessary, only use a mild dish soap with a soft cloth to clean the Console. Do not clean with a petroleum based solvent, automotive cleaner, or any product that contains ammonia. Do not clean the Console in direct sunlight or at high temperatures. Do not apply too much moisture to the Console.

## Adjusting the Belt Tension

If the walking belt starts to slip during use, it is necessary to adjust the tension. Your treadmill has tension bolts at the rear of the treadmill.

1. Remove the Safety Key and place it in a secure location.

**!** When this machine is not in operation, remove the Safety Key and keep out of the reach of children.

2. Make sure that the power switch is turned Off, and the power cord is disconnected.
3. Use a 6 mm hex wrench to turn the right and left belt adjustment bolts clockwise a 1/2 turn, first one bolt and then the other bolt.
4. After you adjust each side the 1/2 turn, inspect the walking belt. From the belt's midpoint, a correctly tensioned belt should only have an inch of give. To check, pull the belt upward at its midpoint and measure the distance to the deck. If the distance is more than an inch, the belt is loose. Repeat this step if necessary.

If you turn one side more than the other, the belt will move away from that side of the treadmill and may need realignment.

**NOTICE:** Too much tension on the belt causes unnecessary friction and wears the belt, motor and electronics.

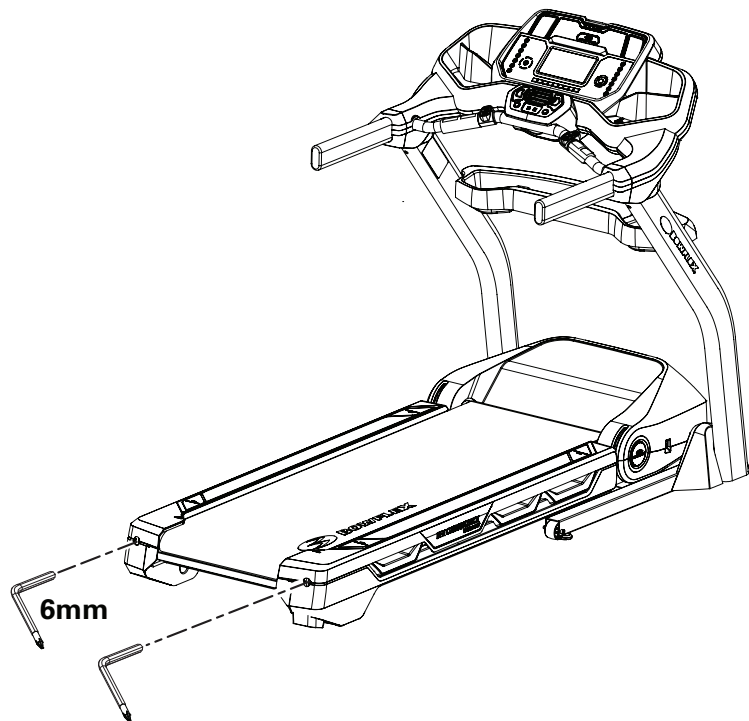

## Aligning the Walking Belt

The walking belt should be centered on your treadmill at all times. Running style and a non-level surface can cause the belt to move off center. Minor adjustments to the 2 bolts at the rear of the treadmill are necessary when the belt is off center.

1. Push the START button to start the walking belt.

**!** Be sure not to touch the walking belt or step on the power cord. Keep bystanders and children away from the product you are servicing at all times.

2. Stand at the rear of the treadmill to see which direction the belt moves.
3. If the belt moves to the left, turn the left belt adjustment bolt 1/4 turn clockwise and the right belt adjustment bolt 1/4 turn counterclockwise.  
If the belt moves to the right, turn the left adjustment bolt 1/4 turn counterclockwise and the right adjustment bolt 1/4 turn clockwise.
4. Monitor the path of the belt for approximately 2 minutes. Continue to adjust the bolts until the walking belt is centered.
5. Push PAUSE/STOP twice to stop the walking belt and end the Quick Start workout.

## Lubricating the Walking Belt

Your treadmill is equipped with a low maintenance deck and belt system. The Walking Belt is pre-lubricated. Belt friction can affect the function and life of the machine. Lubricate the belt every 3 months or every 25 hours of use, whichever comes first. Even if the treadmill is not in use, silicone will dissipate and the belt will dry out. For the best results, lubricate the deck periodically with a silicone lubricant using the following instructions:

1. Turn off the power to the machine with the power switch.
2. Unplug the treadmill fully from the wall outlet, and remove the power cord from the machine.

**⚠ DANGER** To reduce the risk of electrical shock, always unplug the power cord and wait 5 minutes before cleaning, maintaining or repairing this machine. Place the power cord in a secure location.

**Note:** Make sure the treadmill is located on a surface that is easy to clean.

3. Apply a few drops of the lubricant on the deck below the belt. Carefully lift the belt and apply a few drops of the lubricant the entire width of the belt. A very thin layer of silicone lubricant on the entire deck below the belt is desired.

**NOTICE:** Always use a 100% pure silicone lubricant. Do not use a degreaser like WD-40® as this could seriously impact performance. We can recommend that you use the following:

- 100% pure silicone, available at most hardware and auto parts stores.
- Lube-N-Walk® Treadmill Lubrication Kit, available from your local specialty fitness dealer or Nautilus, Inc.

**⚠** Silicone lubricant is not intended for human consumption. Keep out of reach of children. Store in a safe place.

4. Manually rotate the belt 1/2 of the length of the belt and apply lubricant again.

**⚠** If you used spray lubricant, wait 5 minutes before turning on power to the machine to allow the aerosol to dissipate.

5. Connect the power cord back into the machine and then into the wall outlet.
6. Turn on the power to the machine with the power switch.
7. Stay to one side of your machine and start the belt at the slowest speed. Let the belt operate for approximately 15 seconds.

**⚠** Be sure not to touch the walking belt or step on the power cord. Keep bystanders and children away from the product you are servicing at all times.

8. Switch off your machine.
9. Take care to clean up any excess lubricant from the deck.

**⚠** To decrease the possibility of slipping, be sure the deck area is free from grease or oil. Clean off any excess oil from the machine surfaces.

As you use your fitness machine, the Console will show "LUBRICATE BELT" followed by "REVIEW USER MANUAL" at set times. This is only a reminder and should be added to your inspection schedule. Only apply lubricant as necessary. Push any button to accept the reminder.

## Replace Batteries in Chest Strap

The heart rate (HR) chest strap uses a CR2032 battery.

**⚠ Do not perform this procedure outdoors or in moist or wet locations.**

1. Using a coin, loosen the slotted cover on the battery bay. Remove the cover and battery.
2. When replacing the battery, insert it in the battery bay with the + symbol facing up.

**Note:** The chest strap uses CR2032 size batteries.

3. Reinstall the cover on the strap.
4. Discard the old battery. Dispose of in accordance with local regulations and/or at approved recycling centers.
5. Inspect your chest strap to ensure function.

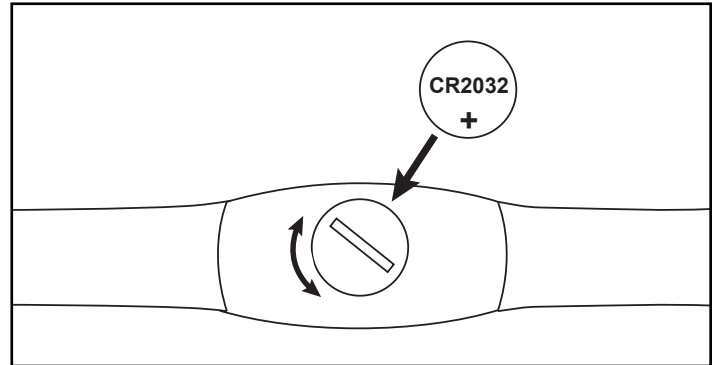

**⚠ Do not use until the equipment has been fully assembled and inspected for correct performance in accordance with the Owner's Manual.**

# Maintenance Parts

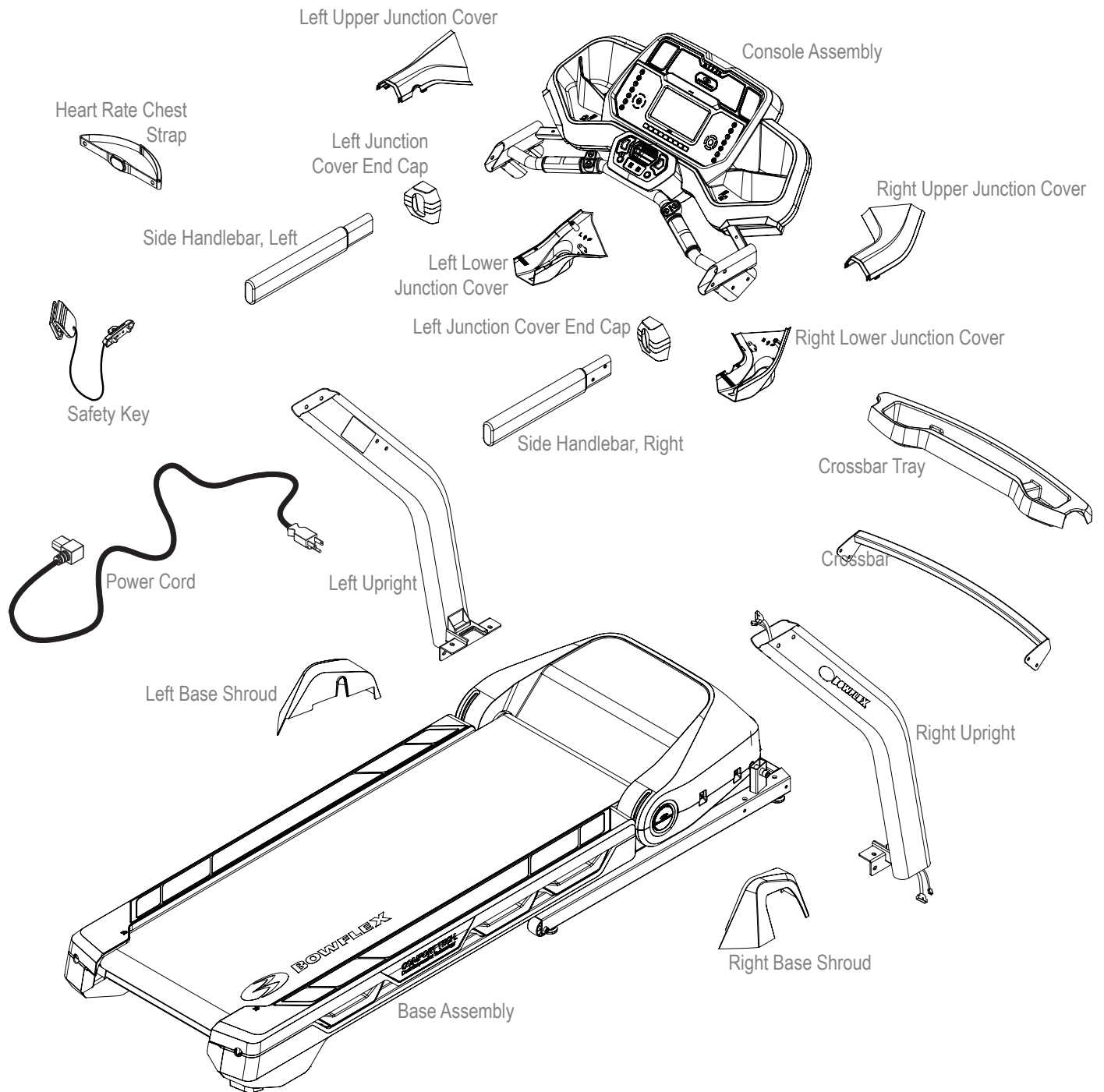

# Maintenance Parts (Base Assembly)

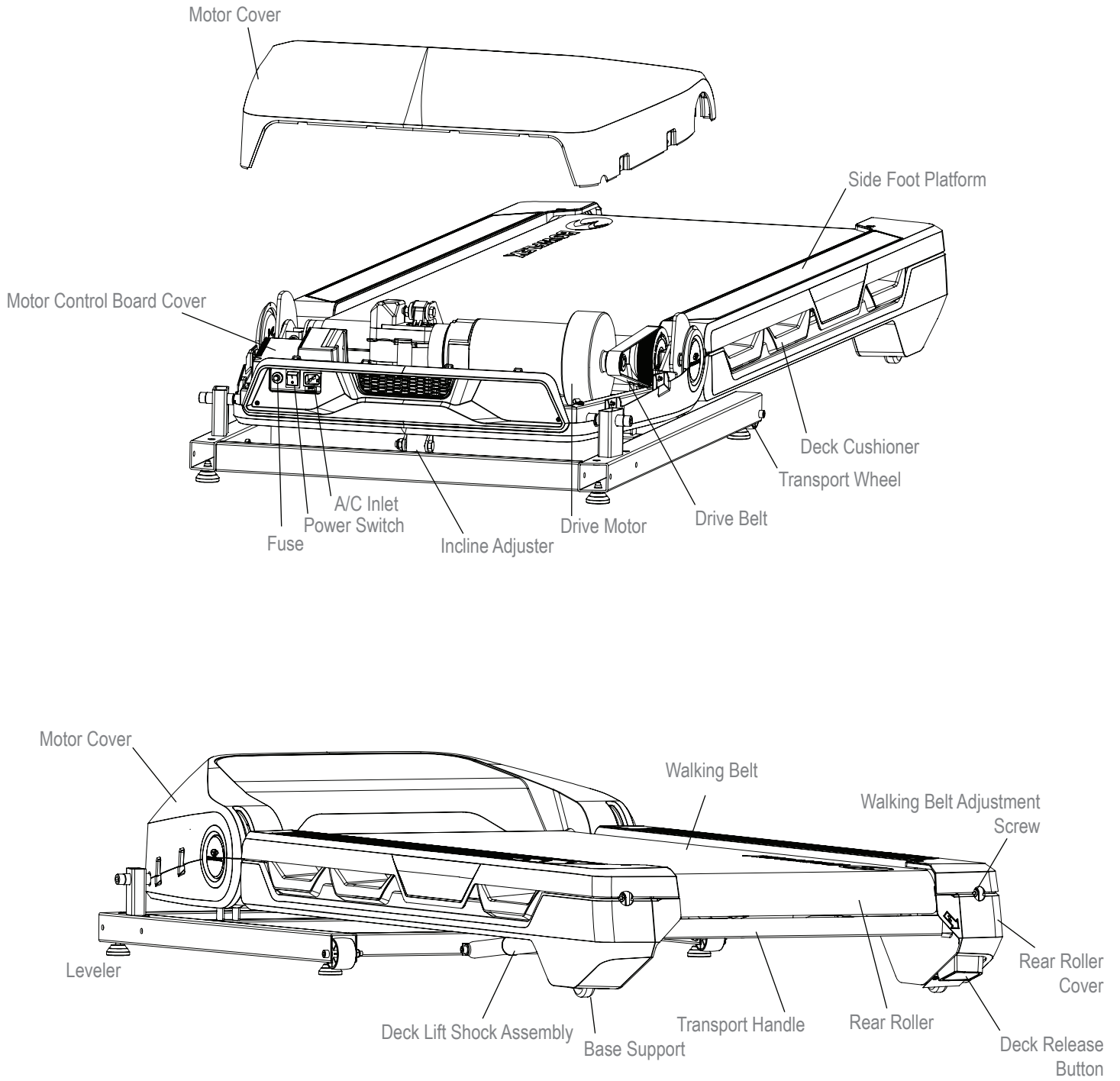



### PROCEDURE 1: MCB COMMUNICATIONS TEST (I/O CABLE TEST):

1. Hold down the PAUSE/STOP button and Down arrow button together for three seconds while at the Welcome screen to enter the Console Setup Mode.
2. The Console displays the TOTAL HOURS screen.
3. Hold down the PAUSE/STOP button and Down arrow button together for 3 seconds to go into the Engineering Mode.
4. Press the Down arrow button 13 times and screen will display TEST MCB.
5. Press Enter to begin the test.
6. The Console will display either MCB PASS or MCB FAIL.
7. If the test results in a fail, I/O communications are interrupted and both I/O cables must be replaced.  
RETURN DEFECTIVE CABLES TO NAUTILUS ATTN: QUALITY

### PROCEDURE 2: CHECK FIRMWARE VERSION AND ERROR LOG:

1. Hold down the PAUSE/STOP button and Down arrow button together for 3 seconds while at the Welcome screen to enter the Console Setup Mode.
2. The Console displays the TOTAL HOURS screen.
3. Push the Right arrow button to show the Console Firmware Version.
4. Record the code.
5. Push the Right arrow button four times.
6. The Console display shows "VIEW ERROR MSG NO" prompt.
7. Push the Up arrow button. The Console will display the "VIEW ERROR MSG YES" prompt.
8. The Console display shows "ERROR LOG VER2". Push ENTER to access the log.
9. Push the Right arrow button and record the code shown.
10. Push the Right arrow button again and record the next code.
11. If you have recorded all the numbers, push the ENTER button and screen will display "ERROR LOG RESET YES". Push Enter.
12. Press PAUSE/STOP to return to Welcome screen.

### PROCEDURE 3: RESET MACHINE (workout data will be lost):

1. Hold down the PAUSE/STOP button and Down arrow button together for 3 seconds while at the Welcome screen to enter the Console Setup Mode.
2. The Console displays the TOTAL HOURS screen.
3. Push the Right arrow button six times until the Console display shows the "RESET CONSOLE NO" prompt.
4. Press the Up arrow button and the screen will display RESET CONSOLE YES.
5. Push the Enter button.
6. Turn the machine off when the Console displays the "POWER CYCLE NOW".

### PROCEDURE 4: CALIBRATE MCB:

1. Hold down the PAUSE/STOP button and Down arrow button together for three seconds while at the Welcome screen to enter the Console Setup Mode.
2. The Console displays the TOTAL HOURS screen.
3. Hold down the PAUSE/STOP button and Down arrow button together for 3 seconds to go into the Engineering Mode.
4. Push the Down arrow button 14 times until the Console displays "ENTR MCB CLB". Be sure the area around the Treadmill is clear of all bystanders, children and pets. Be sure there is nothing on or under the Walking Belt, or near the Treadmill.
5. The Console displays MCB CALIB.
6. With the area clear, push the Enter button. After a pause, the calibration procedure will begin by automatically moving the Walking Belt. Be sure not to touch or allow anyone else to touch the machine while calibration is occurring.
7. When calibration is complete, the Console will display "DONE". Push the PAUSE/STOP button twice.
8. Flip the power switch to OFF. Calibration is now complete for the machine.

**PROCEDURE 5: BUTTON (or KEY) TEST:**

1. Hold down the PAUSE/STOP button and Down arrow button together for three seconds while at the Welcome screen to enter the Console Setup Mode.
  2. The Console displays the TOTAL HOURS screen.
  3. Hold down the PAUSE/STOP button and Down arrow button together for 3 seconds to go into the Engineering Mode.
  4. Push the Down arrow button 9 times until the Console displays "ENTR KEY TEST".
  5. Push the Enter button. The Console will display "BUTTON TEST".
  6. Using the guide below, push the corresponding button in the order provided. Continue through all the buttons.
- Note:** If a faulted button is discovered, the Console may need to be powered down to exit the button test.
7. When the button test is complete, the Console will display "DONE", followed by "BUTTON PASS". Push the PAUSE/STOP button to return to Welcome screen.
  8. Flip the power switch to OFF.

**T116 Button Sequence**

1	Incline 15	14	8 Minute Interval	27	Right Arrow
2	Incline 12	15	16 Minute Interval	28	Down Arrow
3	Incline 9	16	Strength	29	Left Arrow
4	Incline 6	17	Custom	30	Stop
5	Incline 3	18	Speed Confirm	31	Fan
6	Incline 1	19	Speed 1	32	Volume
7	Incline Confirm	20	Speed 3	33	Start
8	User	21	Speed 6	34	Incline +
9	Manual	22	Speed 9	35	Incline -
10	Fat Burn	23	Speed 10	36	Speed +
11	Calorie Burn	24	Speed 12	37	Speed -
12	Calorie Goal	25	Up Arrow	38	
13	Heart Rate	26	Enter	39	

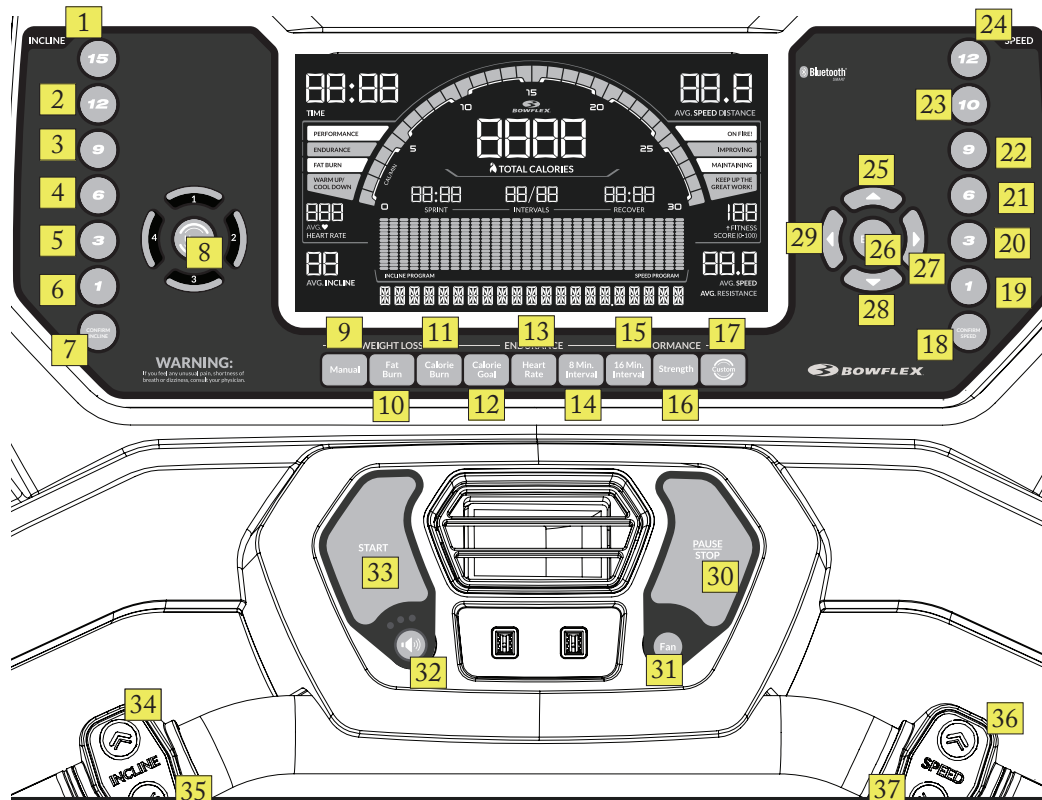

Unit will not power on, or power is on but Console does not light up

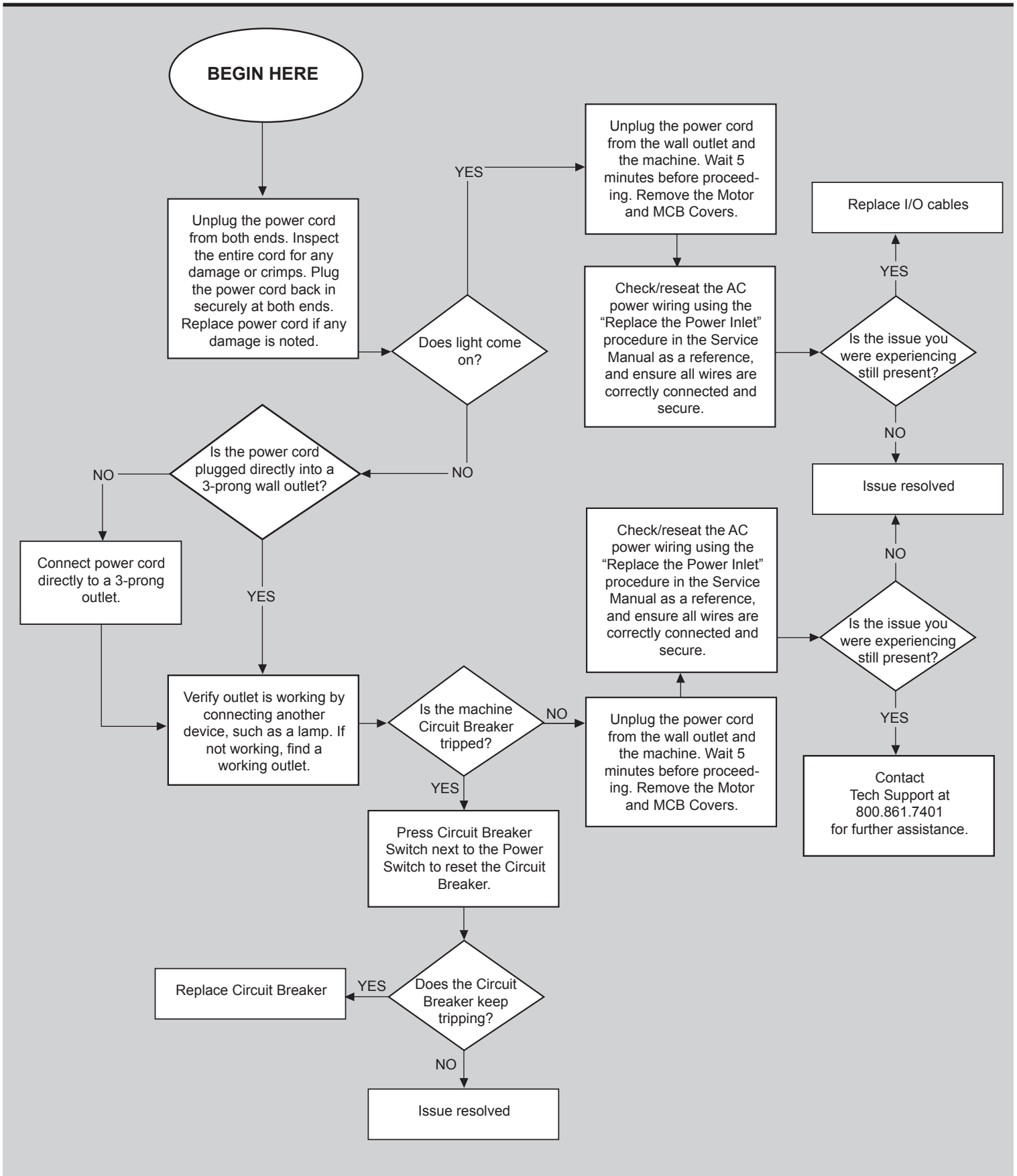

# Noise Issues

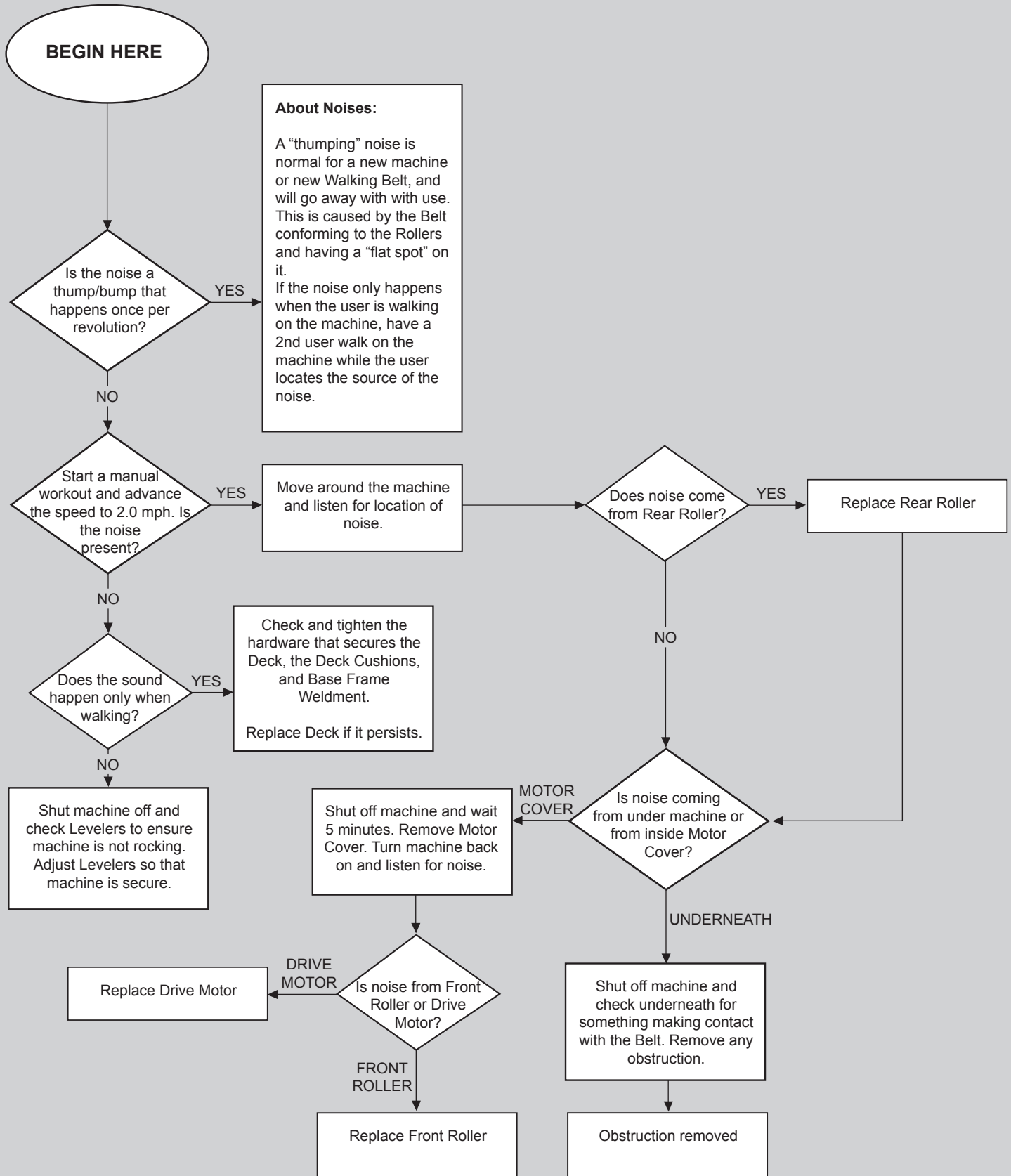

# Machine Shuts Off or Belt Stops During Workout

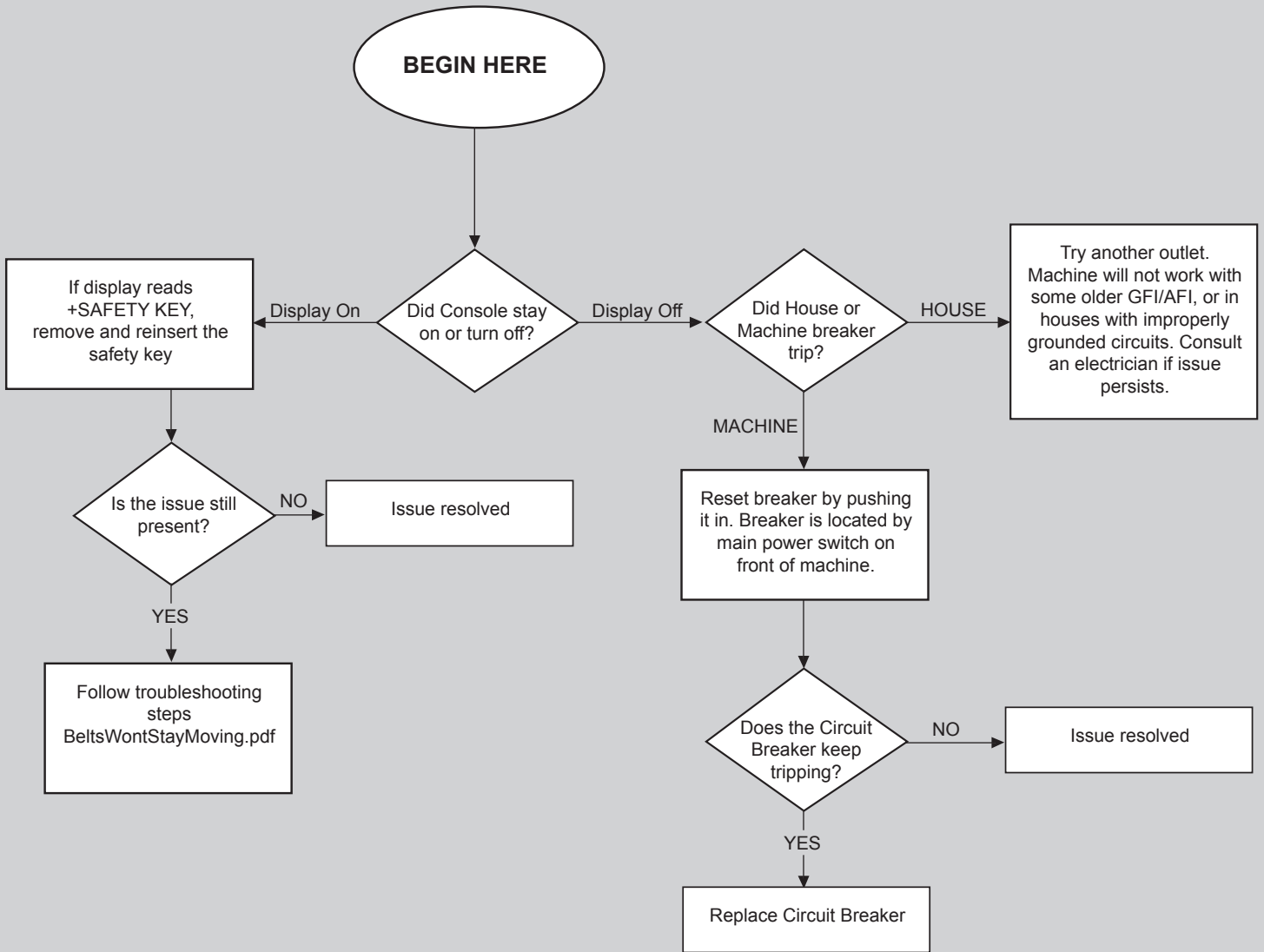

## Incline Issues

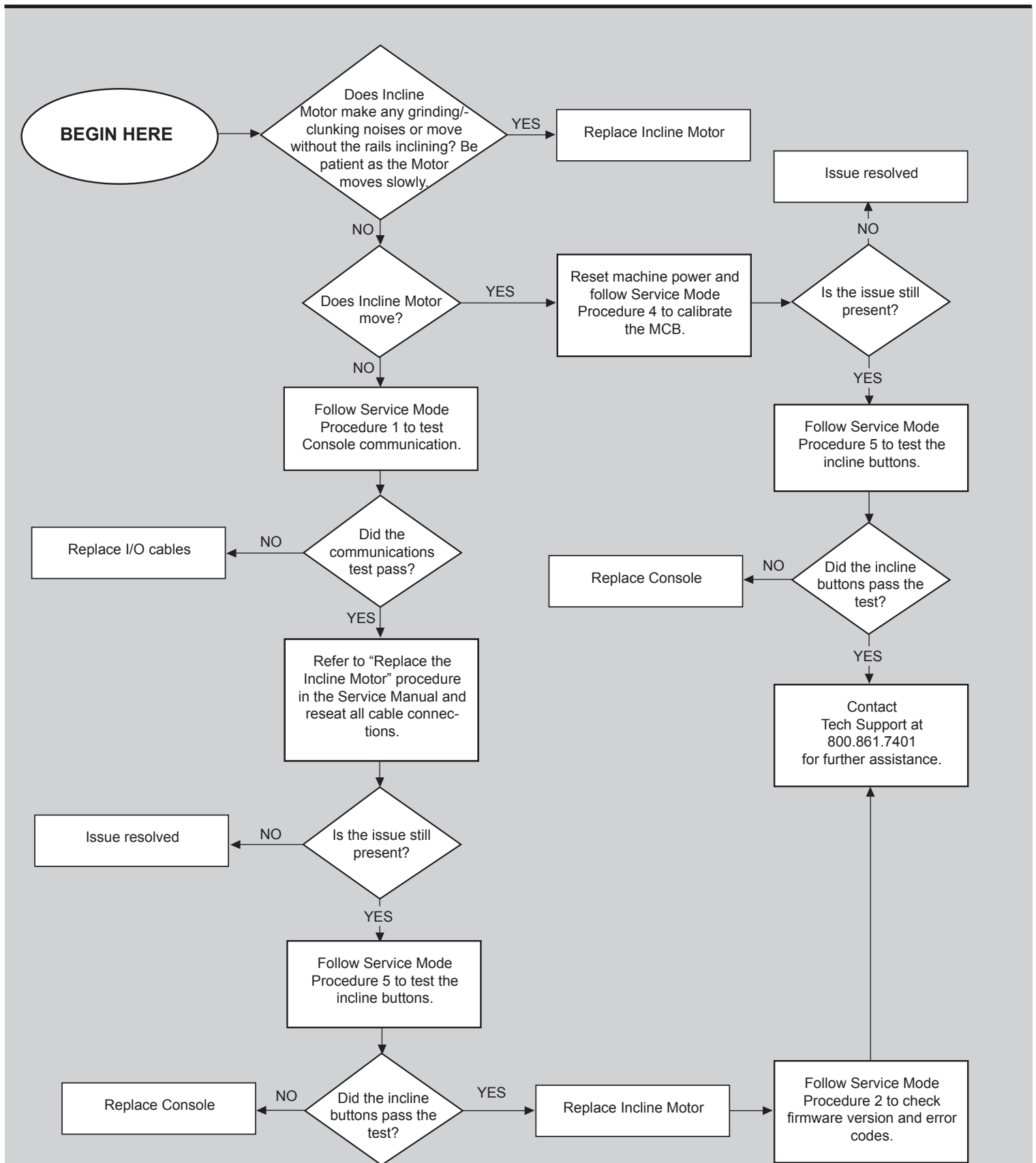

## Heart Rate Issues

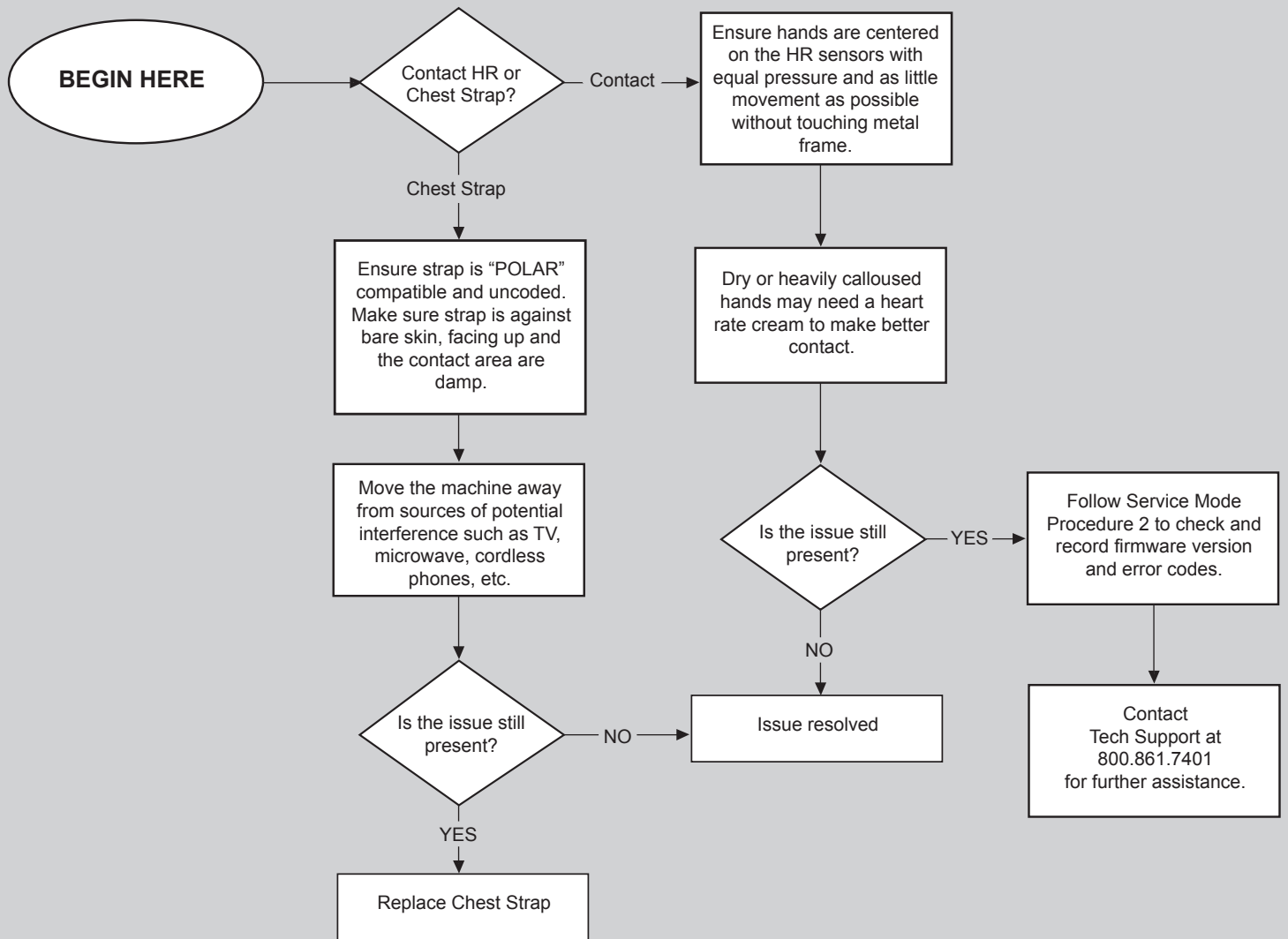

**BEGIN HERE:** If Console will not light up, follow "Unit will not power on" Troubleshooting Procedure. If the units of measure are incorrect, follow the Owner's Manual instructions to correct the setting before beginning these steps.

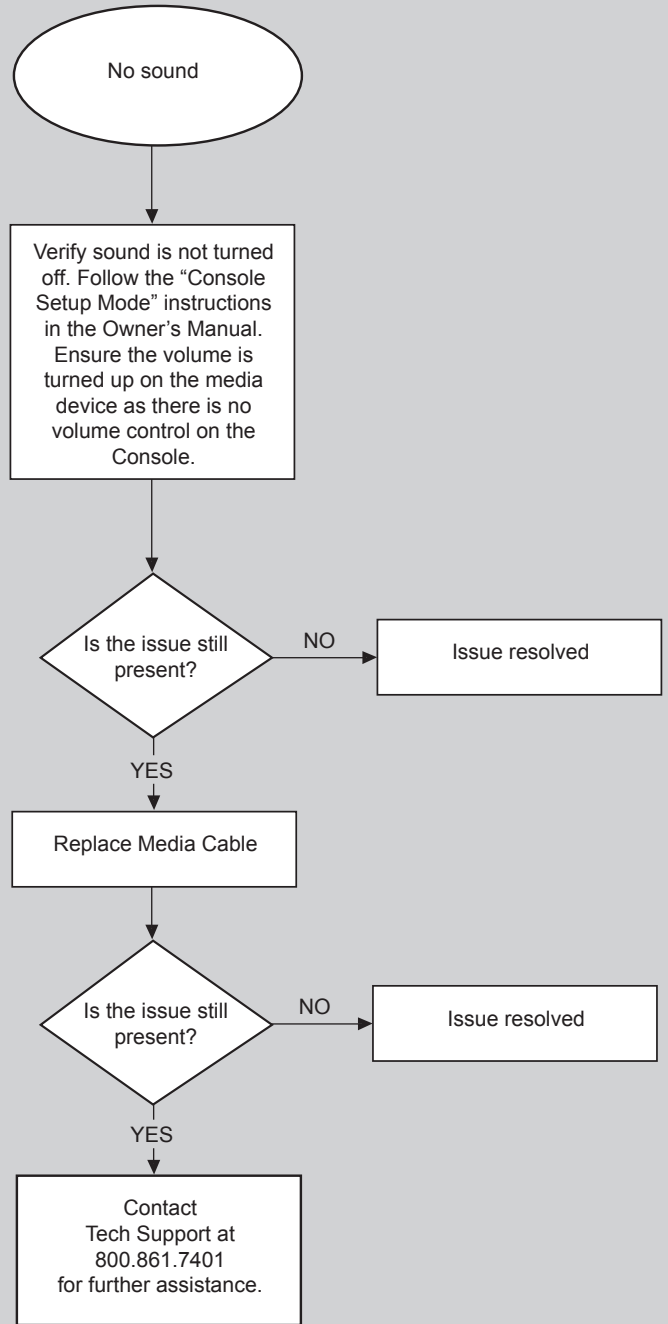
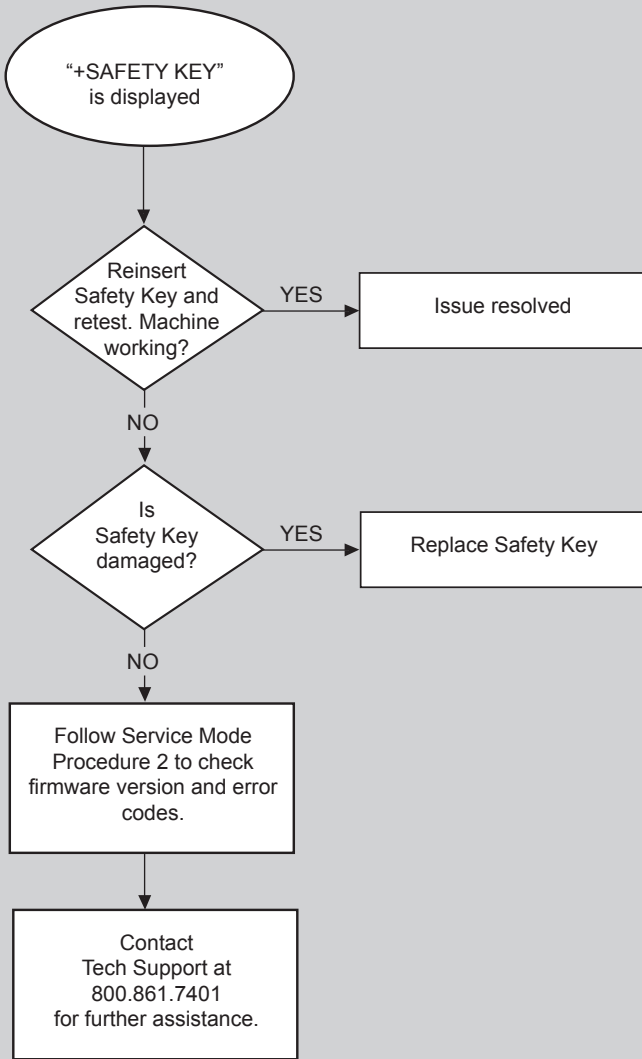



**BEGIN HERE:** If Console will not light up, follow "Unit will not power on" Troubleshooting Procedure.  
If the units of measure are incorrect, follow the Owner's Manual instructions to correct the setting before beginning these steps.

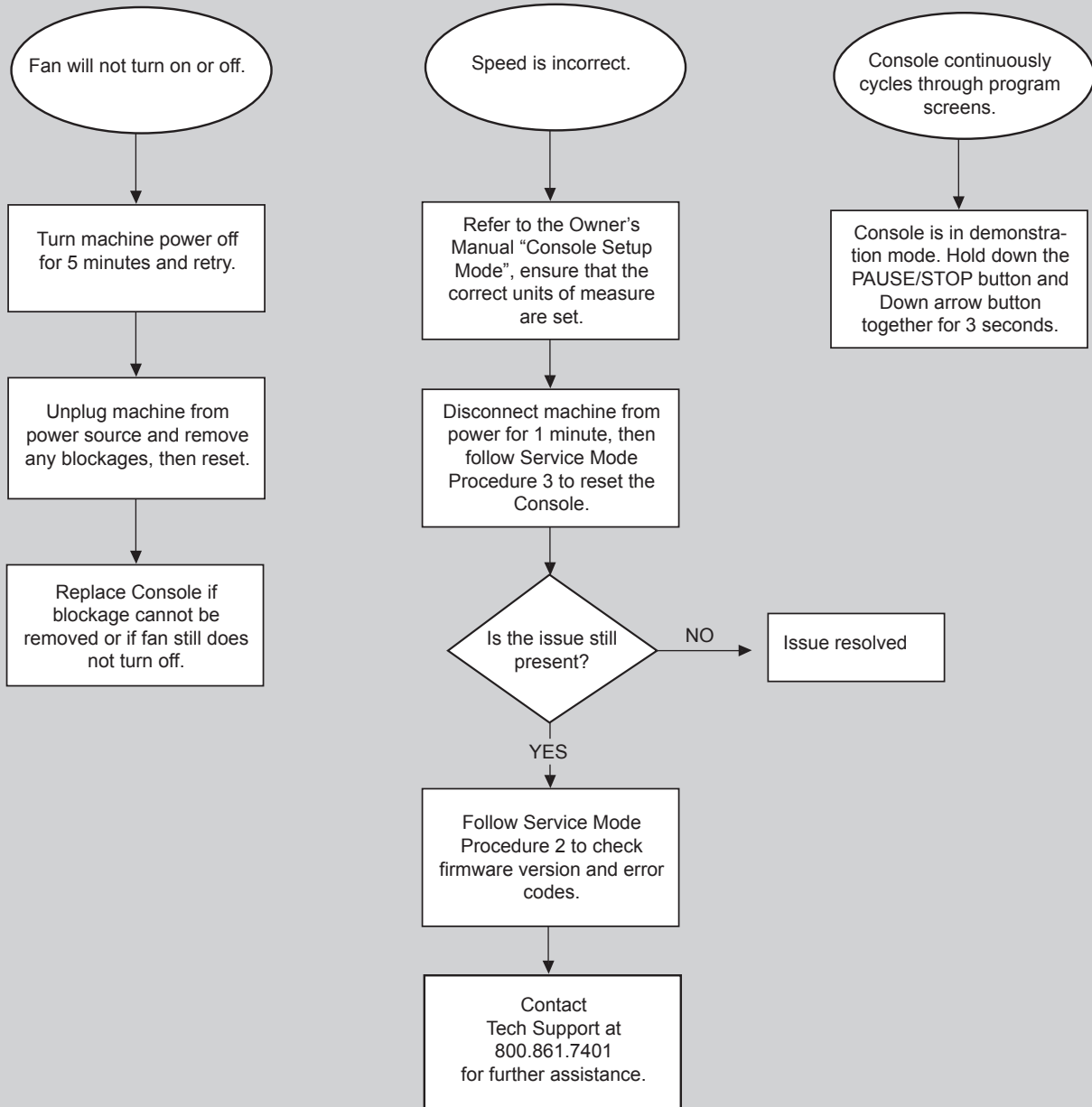

## Buttons Do Not Respond

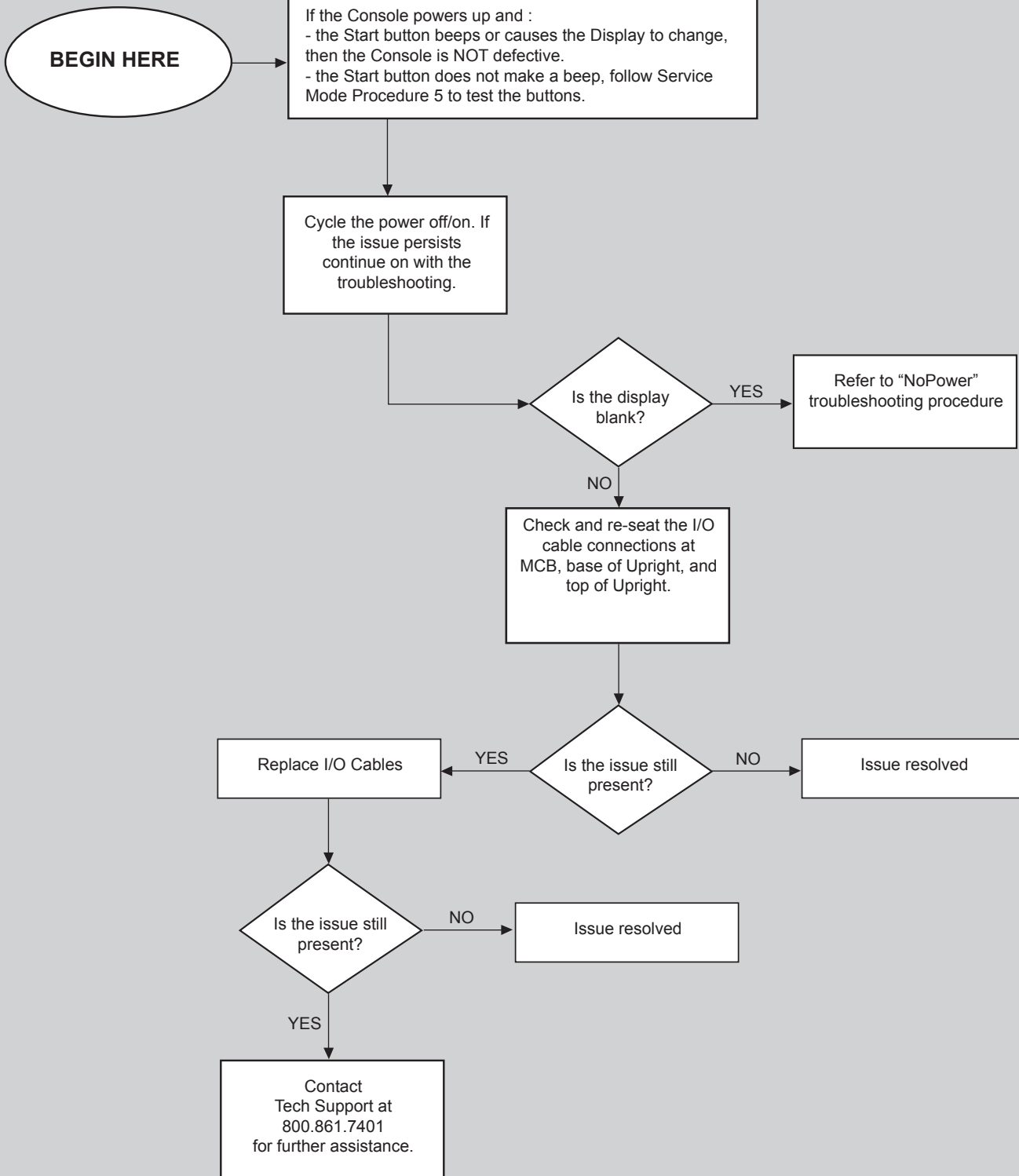

**Walking Belt stops while in use, moves briefly, or does not move at all (Console lights up)**

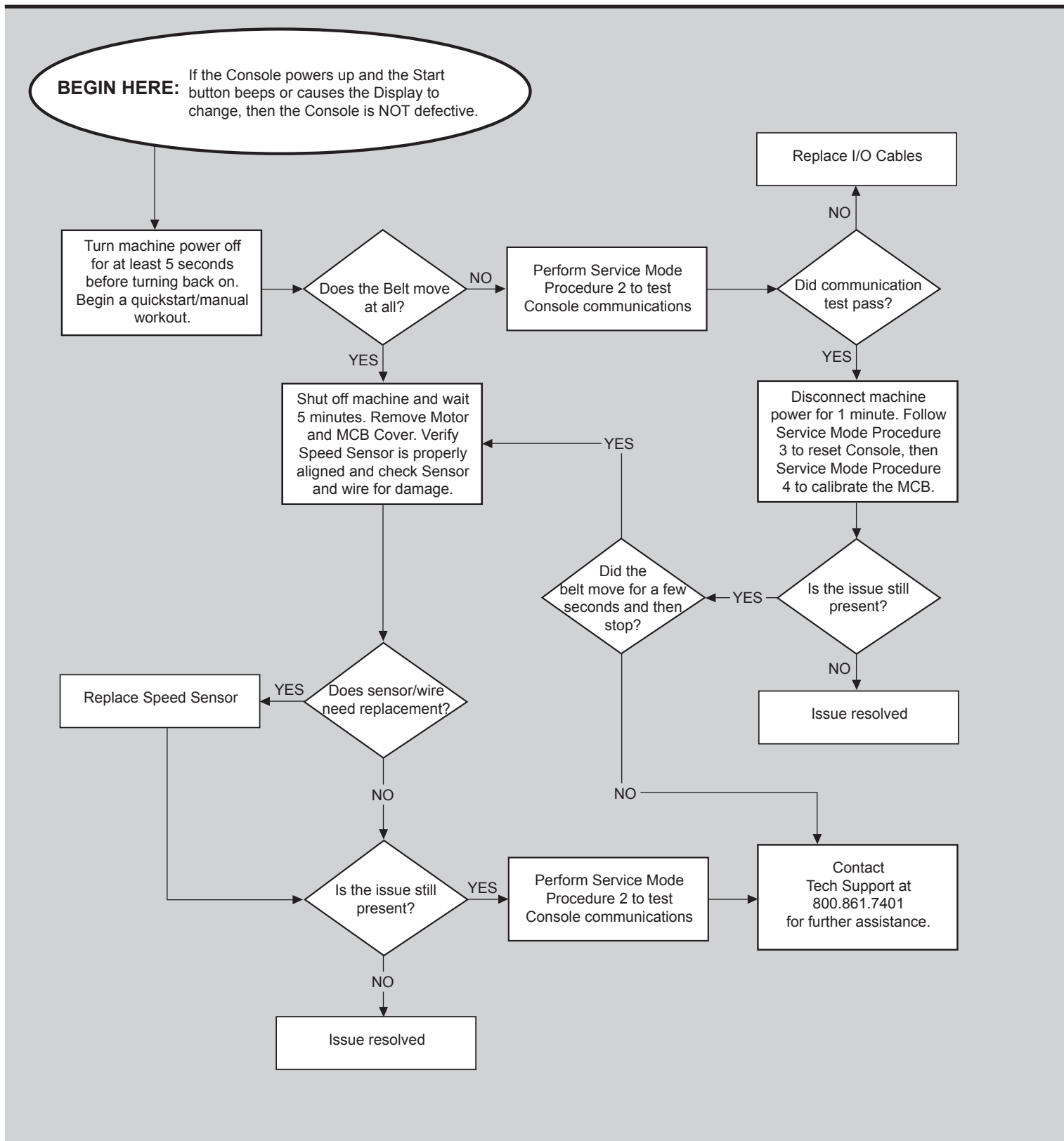

# Belt Alignment / Slipping / Hesitation

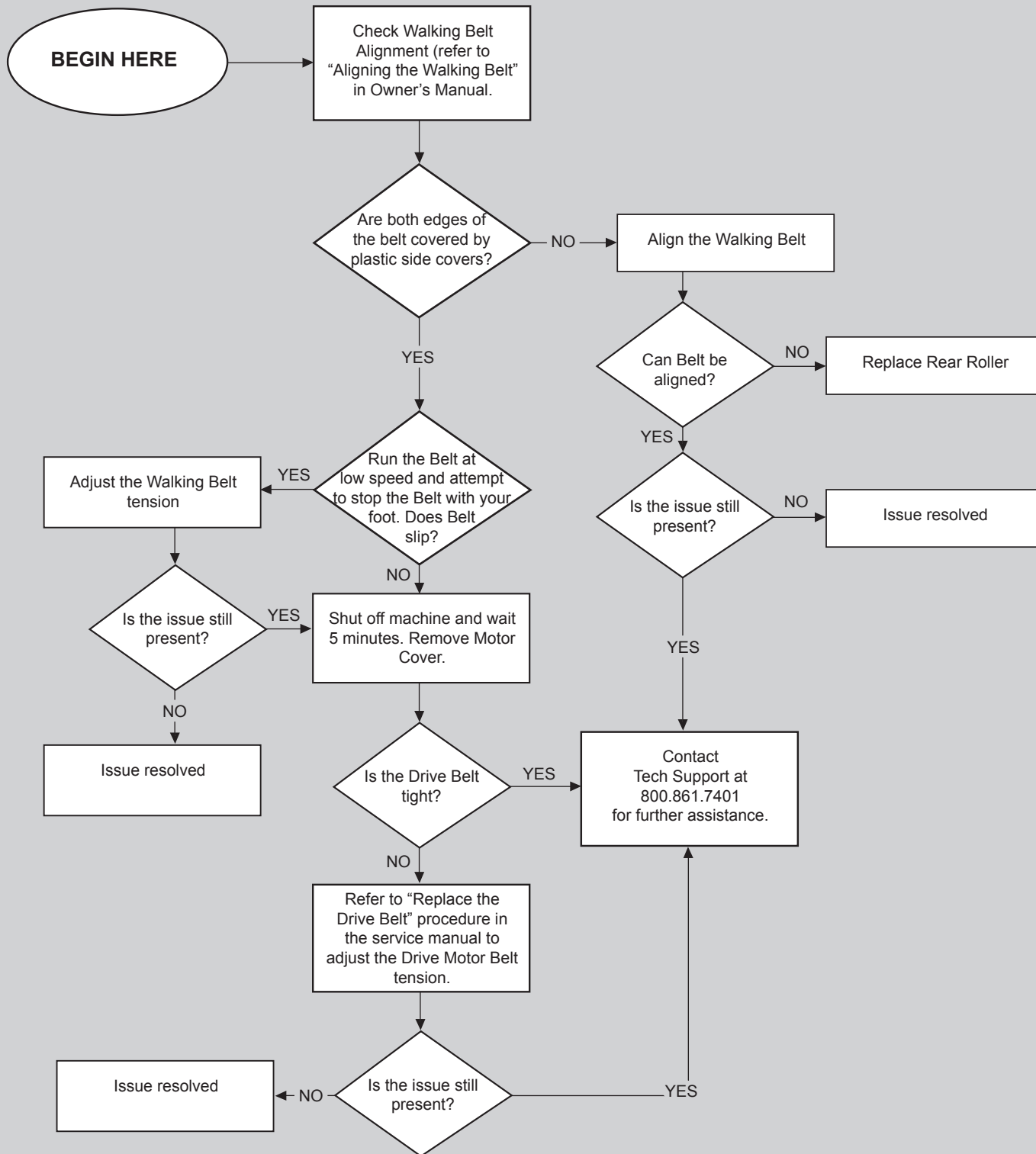

## ***MACHINE SETTINGS MODE***

The Machine Settings Mode lets you view the total run hours for the machine and the current versions of the main systems.

1. Hold down the PAUSE/STOP button and Down button together for 3 seconds while in the Power-Up Mode to access the Machine Settings Mode.

**Note:** Push PAUSE/STOP to exit the Machine Settings Mode and return to the Power-Up Mode screen.

2. The Console displays the TOTAL HOURS for the machine.
3. Push the Right button to go to the next option.
4. The Console display shows the current Console Firmware Version.
5. Push the Right button to go to the next option.
6. The Console display shows the current Motor Control Board Firmware Version.
7. Push the Right button to go to the next option.
8. The Console display shows the current BLE Version.
9. Push the Right button to go to the next option.
10. The Console displays the DISCONNECT BLE NO prompt.

**Note:** If you want to disconnect the Bluetooth® transmitter, push the Increase/Decrease buttons to select the “DISCONNECT BLE YES” option, and push Enter. The Console will exit the Machine Settings Mode and return to the Power-Up Mode screen.

11. Push the Right button to go to the next option.
12. The Console displays the VIEW ERROR MSG NO option. This option is for Service Technicians use only.
13. Push the Right button to go to the next option.
14. The Console displays the RESET CONSOLE NO prompt.

**Note:** If you want to reset the Console to factory settings, push the Increase/Decrease buttons to select the “RESET CONSOLE YES” option, and push Enter. Turn the machine off when the Console displays the “POWER CYCLE NOW” prompt.

15. Push the Right button to exit the Machine Settings Mode and return to the Power-Up Mode screen.

## ***ENGINEERING MODE***

ENGINEERING MODE is a sub-menu from the MACHINE SETTINGS MODE. Most of the options contained within the Engineering Mode are for Service Technicians and should not need to be accessed by a user.

To access the Engineering Mode:

1. From the Power Up (or Welcome) screen, push and hold down the PAUSE/STOP button and Down arrow button for about 5 seconds to go into the Console Setup Mode. The Console display will show the TOTAL HOURS with the current value.

**Note:** Push PAUSE/STOP to exit the Console Setup Mode and return to the Power-Up Mode screen.

2. From the TOTAL HOURS screen, push and hold down the PAUSE/STOP button and Down arrow button for about 5 seconds to go into the Engineering Mode. The Console display will show the current Firmware Version.

Prompts displayed by the Console (in order using the Down arrow button) :

- A. ENTR MFG TEST
- B. Firmware Version ( "xxxxxxxxRxx" )
- C. ENTR NVM (Non-volatile memory) TST
- D. ENTR LCD
- E. ENTR LED TST 1
- F. ENTR LED TST 2
- G. ENTR RTC (Real time clock) TST
- H. ENTR AUD (Audio) TST
- I. ENTR HR TST
- J. ENTR KEY TST
- K. ENTR FAN TST
- L. ENTR BLE (Bluetooth Low Energy) TST
- M. ENTR ESTOP (Emergency Stop) TST
- N. ENTR MCB TST
- O. ENTR MCB CLB (Calibration)
- P. ENTR RST CNSL (Reset Console)

Push the PAUSE/STOP button twice to exit Engineering Mode.

# ELECTRICAL WIRING DIAGRAM

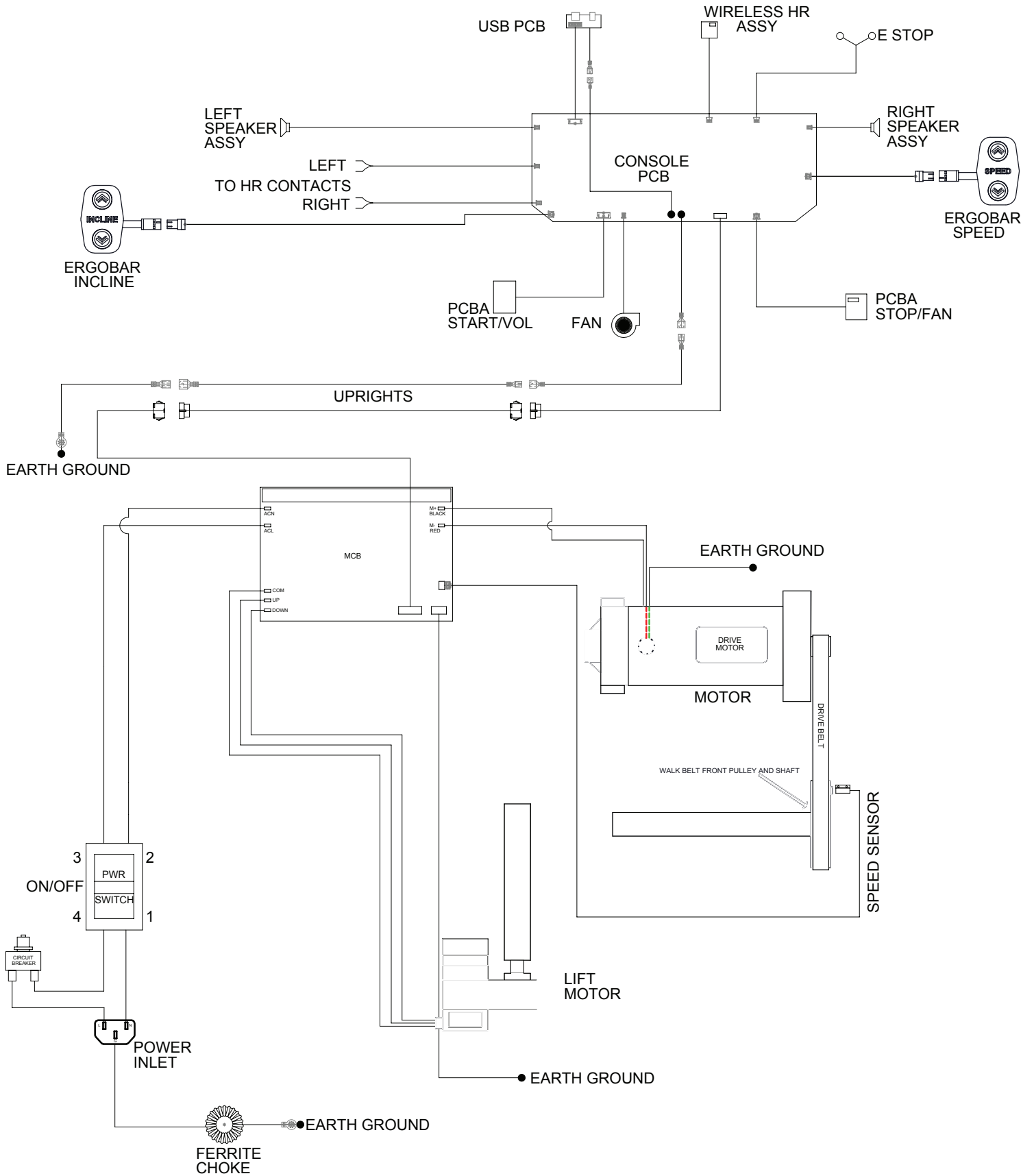

## ***DEMONSTRATION MODE***

Demonstration Mode educates an observer about the console in a trade show or retail environment. During Demonstration Mode, the Console will display each workout Program for 4 seconds from a specific point of the workout. The Fitness machine ships with Demonstration Mode inactive.

1. With the machine at the Power-Up Mode screen, push and hold down the PAUSE/STOP button and the ENTER button for 3 seconds to shift the Console into the Demonstration Mode.

To exit Demonstration mode, push and hold down the PAUSE/STOP button and the ENTER button for 3 seconds.

## **Replacement Procedure Skill Level**

- Level I : Low - very little mechanical knowledge or exposure.
- Level II : Intermediate - some experience with mechanical procedures.
- Level III : Advanced - knowledgeable about mechanical procedures.



**NOTICE:** This document provides instructions on activating/deactivating the demonstration mode on the Bowflex® BXE116/BXE216 Elliptical and BXT116/BXT216 Treadmill machines. When in demonstration mode, the Console will cycle through the workout programs.

**If you need assistance, please call Bowflex Customer Service at 1-800-605-3369.**



**This icon means a potentially hazardous situation which, if not avoided, could result in death or serious injury. Read and understand all Warnings on this machine.**

Nautilus, Inc., (800) 605-3369, www.NautilusInc.com - Customer Service: North America (800) 605-3369, csnl@nautilus.com | outside U.S. www.nautilusinternational.com | Printed in China | © 2017 Nautilus, Inc. | ® indicates trademarks registered in the United States. These marks may be registered in other nations or otherwise protected by common law. Bowflex and the B logo are trademarks owned by or licensed to Nautilus, Inc.

### **Important Safety Instructions - Before servicing or using this equipment, obey the following warnings:**



This icon means a potentially hazardous situation which, if not avoided, could result in death or serious injury. Read and understand all Warnings on this machine.

- Read and understand the Part Replacement Procedure before working on the machine. Failure to obey the instructions and safety warnings could cause injury to the service technician or bystanders.
- Keep bystanders and children away from the product being serviced at all times.
- Make sure that the repair is done in an appropriate work space away from foot traffic and exposure to bystanders.
- Some components of the equipment can be heavy or awkward. Enlist the service of a second person when you do maintenance steps involving these components. Do not try to do heavy or awkward steps on your own.
- If replacement parts are necessary, use only genuine Nautilus replacement parts and hardware. Failure to use genuine replacement parts can cause a risk to users, keep the machine from operating correctly and will void the warranty.
- Be sure that all warning stickers and instructional placards applied to the product stay present and in good condition when doing maintenance or replacing components. If necessary request replacement warning stickers or placards from Nautilus customer service.
- Do not try to change the design or functionality of the machine being serviced as this can adversely effect user safety and will void the warranty.
- Do not use the machine until all shrouds, instructions, warning labels and correct functionality have been verified and tested for correct performance.

The Fitness machine ships with Demonstration Mode inactive.

1. With the machine at the Power-Up Mode screen, push and hold down the ENTER button and the PAUSE/STOP button for 3 seconds to shift the Console into the Demonstration Mode.

During Demonstration Mode, the Console will display each Workout Program for 15 seconds from a specific part of the workout. In addition to the Console showing how each Workout Program functions, the lights and display will show how they relate to the user during a workout.

To deactivate the Demonstration Mode, push and hold down the ENTER button and the PAUSE/STOP button for 3 seconds.

**NOTICE:** This document provides instructions to adjust the Deck Release Assembly on the Bowflex® BXT116 Treadmill.

**If you need assistance, please call Bowflex Customer Service at 1-800-605-3369.**

 **This icon means a potentially hazardous situation which, if not avoided, could result in death or serious injury. Read and understand all Warnings on this machine.**

Nautilus, Inc., (800) NAUTILUS / (800) 628-8458, www.NautilusInc.com - Customer Service: North America (800) 605-3369, csnl@nautilus.com | outside U.S. www.nautilusinternational.com | Printed in China | © 2017 Nautilus, Inc. | ® indicates trademarks registered in the United States. These marks may be registered in other nations or otherwise protected by common law. Bowflex and the B logo are trademarks owned by or licensed to Nautilus, Inc.

### Important Safety Instructions - Before servicing or using this equipment, obey the following warnings:

 **This icon means a potentially hazardous situation which, if not avoided, could result in death or serious injury. Read and understand all Warnings on this machine.**

**⚠ DANGER** To reduce the risk of electrical shock or unsupervised usage of the equipment, always unplug the power cord from the wall outlet and wait 5 minutes before cleaning, maintaining or repairing this machine. Place the power cord in a secure location.

- Read and understand the Part Replacement Procedure before working on the machine. Failure to obey the instructions and safety warnings could cause injury to the service technician or bystanders.
- Keep bystanders, children and pets away from the product being serviced at all times.
- Make sure that the repair is done in an appropriate work space away from foot traffic and exposure to bystanders.
- Disconnect all power and allow to sit for 5 minutes before you service this machine.
- Some components of the equipment can be heavy or awkward. Enlist the service of a second person when you do maintenance steps involving these components. Do not try to do heavy or awkward steps on your own.
- If replacement parts are necessary, use only genuine Nautilus replacement parts and hardware. Failure to use genuine replacement parts can cause a risk to users, keep the machine from operating correctly and will void the warranty.
- Be sure that all warning stickers and instructional placards applied to the product stay present and in good condition when doing maintenance or replacing components. If necessary request replacement warning stickers or placards from Nautilus customer service.
- Do not try to change the design or functionality of the machine being serviced as this can adversely effect user safety and will void the warranty.
- Do not use the machine until all shrouds, instructions, warning labels and correct functionality have been verified and tested for correct performance.

### Tools Required (not included)

10mm wrench

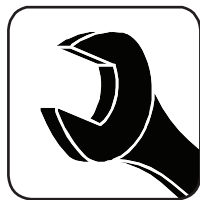

#2 Phillips screwdriver



**⚠ DANGER** To reduce the risk of electrical shock or unsupervised usage of the equipment, always unplug the power cord from the wall outlet and wait 5 minutes before cleaning, maintaining or repairing this machine. Place the power cord in a secure location.

1. Unplug the power cord from the machine and wait 5 minutes. Place the power cord in a secure location.

2. Make sure that there is safe clearance around, on and above the treadmill. Make sure there is no object to spill or cause blockage from the fully folded position.

**⚠** Be sure there is adequate height clearance for the raised deck.

3. Using the support bar found below the rear of the walking belt, push the Deck Release Handle and lift the walking deck fully upward and engage the hydraulic lift. Be sure that the hydraulic lift is correctly locked in place. You will hear an audible click when the hydraulic lift shifts into the locked position.

**⚠** Use proper safety precautions and lifting techniques. Bend your knees and elbows, keep your back straight and pull up equally with both arms. Straighten your legs to lift. Make sure that your own physical strength is capable of lifting the walking deck until it engages the locking mechanism. Use a second person if necessary.

**Do not use the walking belt or rear roller to lift the treadmill. These parts do not lock in place and can abruptly move. Injury to you or damage to the machine can occur.**

4. Make sure that the locking mechanism is engaged. Carefully pull back on the walking deck and make sure that it does not move. When you do this, keep clear of movement path in case the treadmill lock is not properly engaged.

**⚠** Do not lean against the treadmill when it is folded. Do not put items on it that could cause it to become unstable or fall.

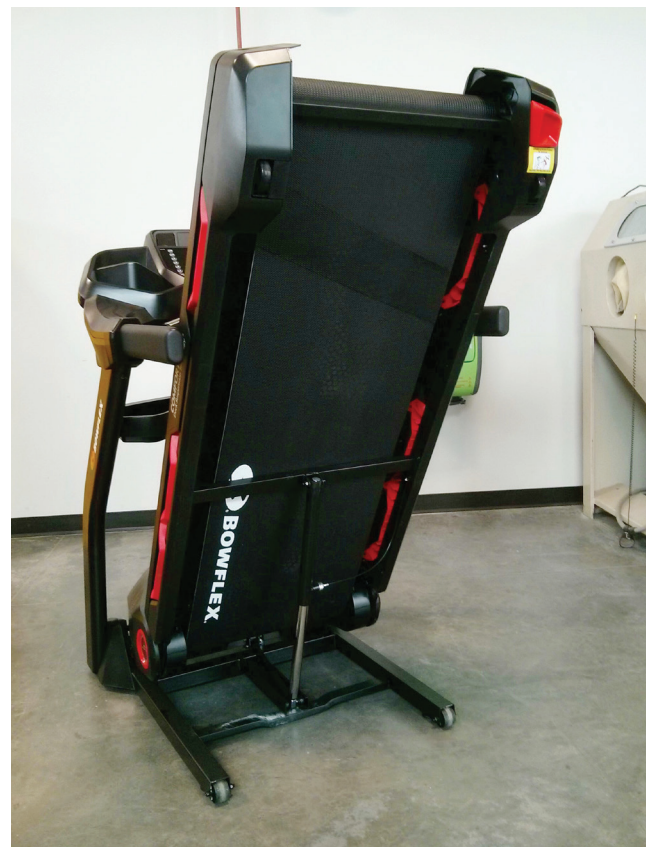

5. Using a #2 Phillips screwdriver, remove the two indicated screws from the Rear Roller Cover.

6. Remove the Rear Roller Cover noting how it attaches for re-assembly.



7. Using a 10mm wrench, loosen the indicated hardware and adjust the cable.

8. Tighten the hardware when adjusted.

9. Make sure there is sufficient space to lower the walking deck.

**⚠ Keep a minimum clearance behind the machine of 79" (2 m) and 24" (0.6 m) on each side. This is the recommended safe distance for access, movement and emergency dismounts from the machine.**

10. Make sure there is no object on or around the treadmill to spill or cause blockage from the fully unfolded position.

11. Slightly push the walking deck forward toward the console, and then push the Deck Release Handle until the locking tube releases and you can pull the walking deck away from the console. Hold up the rear of the walking deck, and move to the side of the machine.

**⚠ Keep clear of the movement path of the walking deck.**

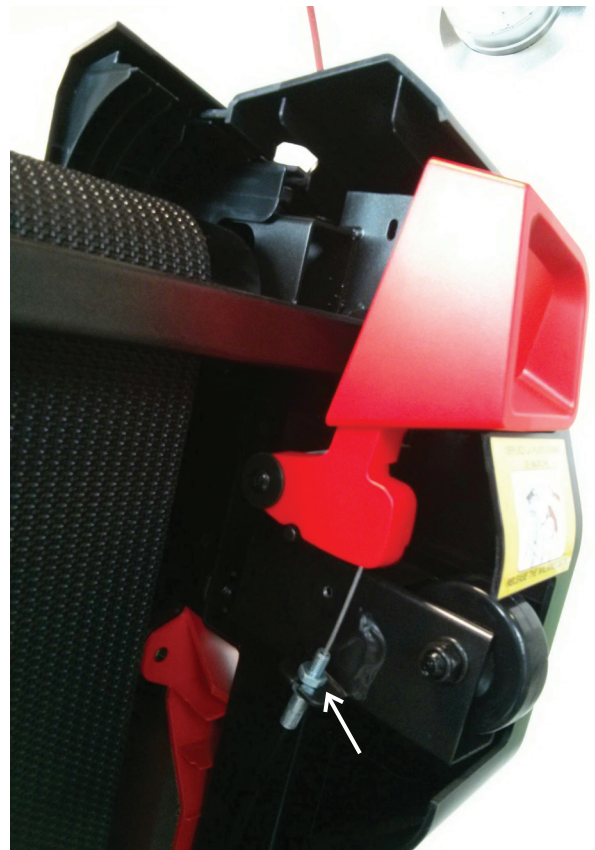

12. The hydraulic lift is set up to drop gradually. Hold onto the walking deck until approximately 2/3 of the movement down. Make sure that you use proper lifting technique; bend your knees and keep your back straight. Lower the weight with your legs. Be aware that the walking deck can possibly drop quickly in the last part of the movement.

13. Final Inspection

Inspect your machine to ensure that all hardware is tight and components are properly assembled.



**Do not use until the machine has been fully assembled and inspected for correct performance in accordance with the Owner's Manual.**

**NOTICE:** This document provides instructions to adjust the Walking Belt on the Bowflex® BXT116 / BXT216 Treadmills.

**If you need assistance, please call Bowflex Customer Service at 1-800-605-3369.**

 **This icon means a potentially hazardous situation which, if not avoided, could result in death or serious injury. Read and understand all Warnings on this machine.**

Nautilus, Inc., (800) NAUTILUS / (800) 628-8458, www.NautilusInc.com - Customer Service: North America (800) 605-3369, csnl@nautilus.com | outside U.S. www.nautilusinternational.com | Printed in China | © 2017 Nautilus, Inc. | ® indicates trademarks registered in the United States. These marks may be registered in other nations or otherwise protected by common law. Bowflex and the B logo are trademarks owned by or licensed to Nautilus, Inc.

### Important Safety Instructions - Before servicing or using this equipment, obey the following warnings:

 **This icon means a potentially hazardous situation which, if not avoided, could result in death or serious injury. Read and understand all Warnings on this machine.**

**⚠ DANGER** To reduce the risk of electrical shock or unsupervised usage of the equipment, always unplug the power cord from the wall outlet and wait 5 minutes before cleaning, maintaining or repairing this machine. Place the power cord in a secure location.

- Read and understand the Part Replacement Procedure before working on the machine. Failure to obey the instructions and safety warnings could cause injury to the service technician or bystanders.
- Keep bystanders, children and pets away from the product being serviced at all times.
- Make sure that the repair is done in an appropriate work space away from foot traffic and exposure to bystanders.
- Disconnect all power and allow to sit for 5 minutes before you service this machine.
- Some components of the equipment can be heavy or awkward. Enlist the service of a second person when you do maintenance steps involving these components. Do not try to do heavy or awkward steps on your own.
- If replacement parts are necessary, use only genuine Nautilus replacement parts and hardware. Failure to use genuine replacement parts can cause a risk to users, keep the machine from operating correctly and will void the warranty.
- Be sure that all warning stickers and instructional placards applied to the product stay present and in good condition when doing maintenance or replacing components. If necessary request replacement warning stickers or placards from Nautilus customer service.
- Do not try to change the design or functionality of the machine being serviced as this can adversely effect user safety and will void the warranty.
- Do not use the machine until all shrouds, instructions, warning labels and correct functionality have been verified and tested for correct performance.

### Tools Required (not included)

6mm hex wrench



**Note:** The Bowflex® BXT116 is used in the following images. The procedure is the same for the BXT216 model.

1. Run the machine at 1 mph to see which way the Walking Belt needs to be moved.

 **Do not touch the Walking Belt. Be sure to keep bystanders, children and pets away from the machine.**

2. Using a 6mm hex wrench on the side the belt should move away from, rotate the Adjustment Bolt a 1/4 turn clock-wise.

3. Allow the Walking Belt to adjust to the new tension.

4. Repeat steps 2 and 3 until the Walking Belt is centered.

5. Final Inspection

Inspect your machine to ensure that all hardware is tight and components are properly assembled.

 **Do not use until the machine has been fully assembled and inspected for correct performance in accordance with the Owner's Manual.**

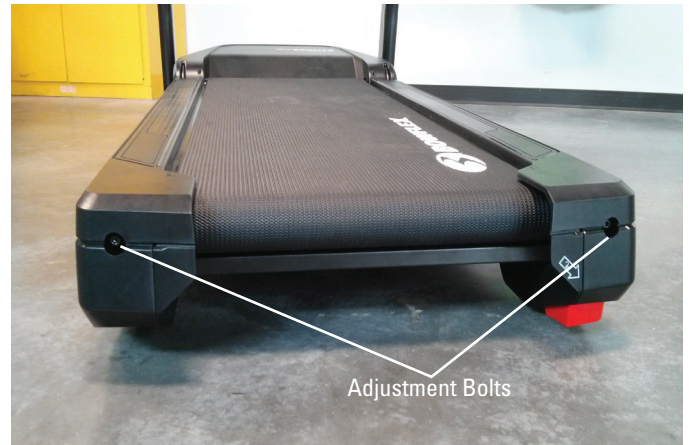

**NOTICE:** This document provides instructions to correct the clunking noise on the Bowflex® BXT116 / BXT216 Treadmill.

**If you need assistance, please call Bowflex Customer Service at 1-800-605-3369.**

 **This icon means a potentially hazardous situation which, if not avoided, could result in death or serious injury. Read and understand all Warnings on this machine.**

Nautilus, Inc., www.NautilusInc.com - Customer Service: North America (800) 605-3369, csnl@nautilus.com | outside U.S. www.nautilusinternational.com | Printed in China | © 2018 Nautilus, Inc. | ® indicates trademarks registered in the United States. These marks may be registered in other nations or otherwise protected by common law. Bowflex and the B logo are trademarks owned by or licensed to Nautilus, Inc. Goof Off® is a trademark of their respective owners.

### Important Safety Instructions - Before servicing or using this equipment, obey the following warnings:

 **This icon means a potentially hazardous situation which, if not avoided, could result in death or serious injury. Read and understand all Warnings on this machine.**

**⚠ DANGER** To reduce the risk of electrical shock or unsupervised usage of the equipment, always unplug the power cord from the wall outlet and wait 5 minutes before cleaning, maintaining or repairing this machine. Place the power cord in a secure location.

- Read and understand the Part Replacement Procedure before working on the machine. Failure to obey the instructions and safety warnings could cause injury to the service technician or bystanders.
- Keep bystanders, children and pets away from the product being serviced at all times.
- Make sure that the repair is done in an appropriate work space away from foot traffic and exposure to bystanders.
- Disconnect all power and allow to sit for 5 minutes before you service this machine.
- Some components of the equipment can be heavy or awkward. Enlist the service of a second person when you do maintenance steps involving these components. Do not try to do heavy or awkward steps on your own.
- If replacement parts are necessary, use only genuine Nautilus replacement parts and hardware. Failure to use genuine replacement parts can cause a risk to users, keep the machine from operating correctly and will void the warranty.
- Be sure that all warning stickers and instructional placards applied to the product stay present and in good condition when doing maintenance or replacing components. If necessary request replacement warning stickers or placards from Nautilus customer service.
- Do not try to change the design or functionality of the machine being serviced as this can adversely effect user safety and will void the warranty.
- Do not use the machine until all shrouds, instructions, warning labels and correct functionality have been verified and tested for correct performance.

### Tools Required (not included)

14mm wrench

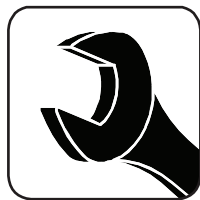

Utility knife

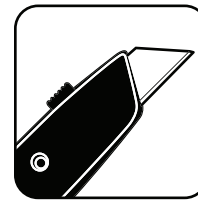

Rubbing alcohol or other cleaner (Goof Off®, etc.)

Paper towels





**⚠ DANGER** To reduce the risk of electrical shock or unsupervised usage of the equipment, always unplug the power cord from the wall outlet and wait 5 minutes before cleaning, maintaining or repairing this machine. Place the power cord in a secure location.

1. Unplug the power cord from the machine and wait 5 minutes. Place the power cord in a secure location.

2. Make sure that there is safe clearance around, on and above the treadmill. Make sure there is no object to spill or cause blockage from the fully folded position.

**⚠** Be sure there is adequate height clearance for the raised deck.

3. Using the support bar found below the rear of the walking belt, push the Deck Release Handle and lift the walking deck fully upward and engage the hydraulic lift. Be sure that the hydraulic lift is correctly locked in place. You will hear an audible click when the hydraulic lift shifts into the locked position.

**⚠** Use proper safety precautions and lifting techniques. Bend your knees and elbows, keep your back straight and grasp equally with both hands. Straighten your legs to lift. Make sure that your own physical strength is capable of lifting the walking deck until it engages the locking mechanism. Use a second person if necessary.

**Do not use the walking belt or rear roller to lift the treadmill. These parts do not lock in place and can abruptly move. Injury to you or damage to the machine can occur.**

4. Make sure that the locking mechanism is engaged. Carefully pull back on the walking deck and make sure that it does not move. When you do this, keep clear of movement path in case the treadmill lock is not properly engaged.

**⚠** Do not lean against the treadmill when it is folded. Do not put items on it that could cause it to become unstable or fall.



5. Make sure that there is safe clearance around, above, and to one side of the treadmill. Tilt the machine onto the side being sure not to grasp the Console.

**!** A second person is required to assist with the tilting of the machine. Do not tilt the machine unless the walking deck is in the folded, locked position. Be sure there is adequate clearance for the raised deck. Some components of the equipment can be heavy or awkward. Enlist the service of a second person when you do maintenance steps involving these components. Do not try to do heavy or awkward steps on your own.



**DANGER** The following images show the machine upright, and not fully resting on its side. The machine must be on its side to safely complete the following steps.

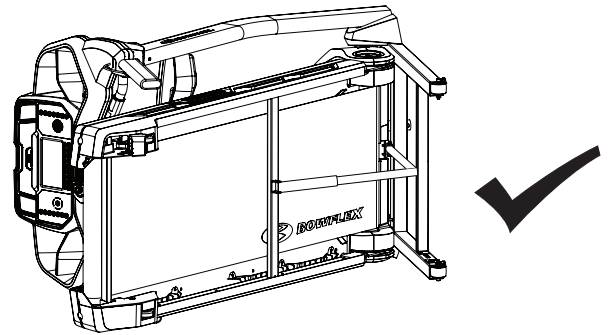

6. Using a 14mm wrench, disconnect the securing nut (indicated by oval) and remove the hardware from the Lift Shock.

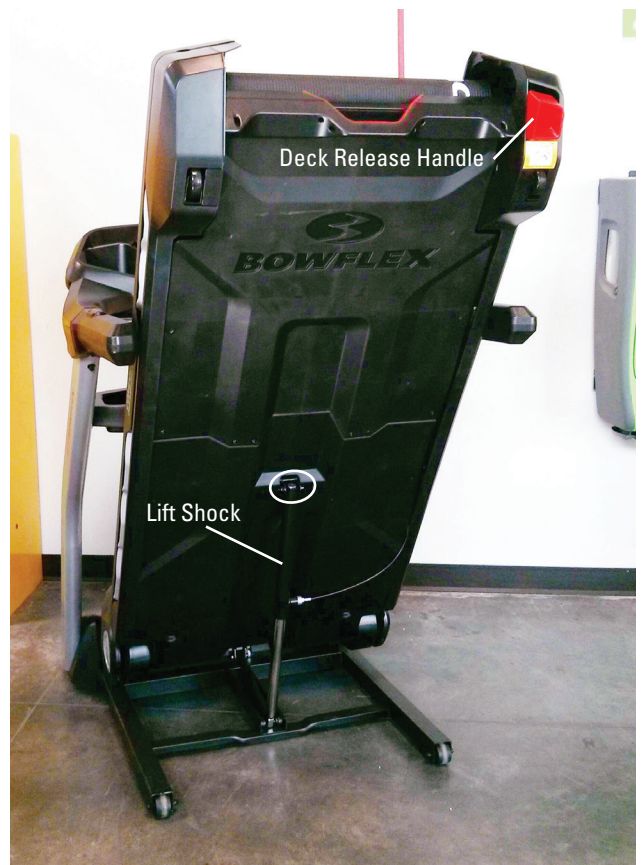

7. Push the Deck Release Handle to disengage the Plunger within the Lift Shock, and remove the outer (black) tube from the Lift Shock (as shown here).



8. Scrape off any tape from the inner (silver) tube using a utility knife or blade. Remove as much tape as possible. Remove any remaining tape residue from silver tube by cleaning with paper towel and rubbing alcohol or other cleaner (Goof Off®, etc.). The entire silver tube should be completely clean/free of residue.

**⚠ Be extremely careful and be sure to cut away from yourself. Always keep your other hand out of the direction of the blade.**



9. Using the cleaning materials from Step #8, completely clean the inner surface of the bushing inside the end of the black tube. The inner surface should be free of all foam and adhesive when finished. The inner tube should move freely inside the outer tube.

10. Re-assemble the machine in the reverse order of when the parts were removed.

11. Make sure there is sufficient space to lower the walking deck.

**⚠ Keep a minimum clearance behind the machine of 79" (2 m) and 24" (0.6 m) on each side. This is the recommended safe distance for access, movement and emergency dismounts from the machine.**

12. Make sure there is no object on or around the treadmill to spill or cause blockage from the fully unfolded position.

13. Slightly push the walking deck forward toward the console, and then push the Deck Release Handle until the locking tube releases and you can pull the walking deck away from the console. Hold up the rear of the walking deck, and move to the side of the machine.

**⚠ Keep clear of the movement path of the walking deck.**

14. The hydraulic lift is set up to drop gradually. Hold onto the walking deck until approximately 2/3 of the movement down. Make sure that you use proper lifting technique; bend your knees and keep your back straight. Lower the weight with your legs. Be aware that the walking deck can possibly drop quickly in the last part of the movement.

15. Connect the power cord back into the machine and then into the wall outlet.

16. Turn on the power to the machine with the power switch.

17. Stay to one side of your machine and start the belt at the slowest speed. Increase the belt to speed 6 and cycle through all the incline levels. The noise should be gone at all levels.

**⚠ Be sure not to touch the walking belt or step on the power cord. Keep bystanders and children away from the product you are servicing at all times.**

18. Switch off your machine.

19. Final Inspection  
Inspect your machine to ensure that all hardware is tight and components are properly assembled.

**⚠ Do not use until the machine has been fully assembled and inspected for correct performance in accordance with the Owner's Manual.**

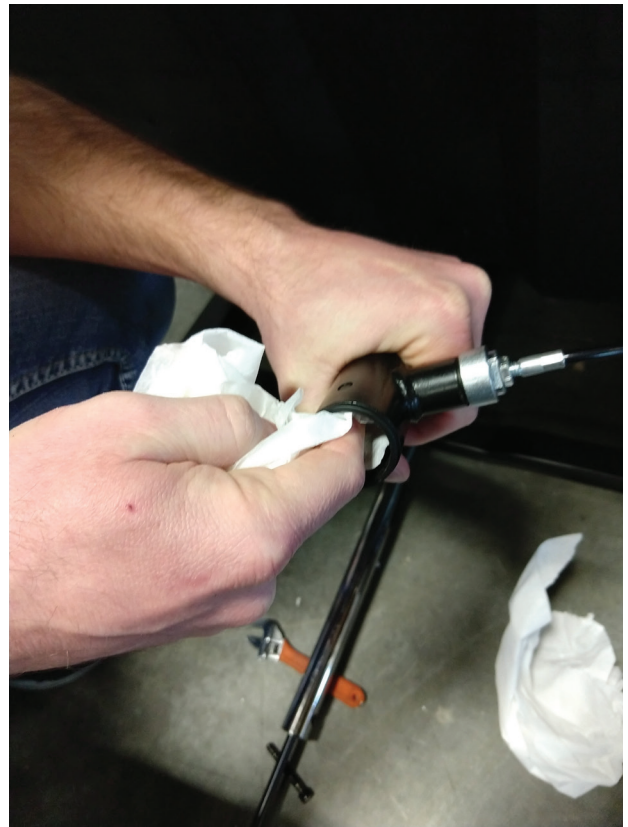

**NOTICE:** This document provides instructions for the replacement of the Bottom Motor Cover on the Bowflex® BXT116 / BXT216 Treadmills.

**If you need assistance, please call Bowflex Customer Service at 1-800-605-3369.**

 **This icon means a potentially hazardous situation which, if not avoided, could result in death or serious injury. Read and understand all Warnings on this machine.**

Nautilus, Inc., www.NautilusInc.com - Customer Service: North America (800) 605-3369, csnl@nautilus.com | outside U.S. www.nautilusinternational.com | Printed in China | © 2017 Nautilus, Inc. | ® indicates trademarks registered in the United States. These marks may be registered in other nations or otherwise protected by common law. Bowflex and the B logo are trademarks owned by or licensed to Nautilus, Inc.

### Important Safety Instructions - Before servicing or using this equipment, obey the following warnings:

 **This icon means a potentially hazardous situation which, if not avoided, could result in death or serious injury. Read and understand all Warnings on this machine.**

**⚠ DANGER** **To reduce the risk of electrical shock or unsupervised usage of the equipment, always unplug the power cord from the wall outlet and wait 5 minutes before cleaning, maintaining or repairing this machine. Place the power cord in a secure location.**

- Read and understand the Part Replacement Procedure before working on the machine. Failure to obey the instructions and safety warnings could cause injury to the service technician or bystanders.
- Keep bystanders, children and pets away from the product being serviced at all times.
- Make sure that the repair is done in an appropriate work space away from foot traffic and exposure to bystanders.
- Disconnect all power and allow to sit for 5 minutes before you service this machine.
- Some components of the equipment can be heavy or awkward. Enlist the service of a second person when you do maintenance steps involving these components. Do not try to do heavy or awkward steps on your own.
- If replacement parts are necessary, use only genuine Nautilus replacement parts and hardware. Failure to use genuine replacement parts can cause a risk to users, keep the machine from operating correctly and will void the warranty.
- Be sure that all warning stickers and instructional placards applied to the product stay present and in good condition when doing maintenance or replacing components. If necessary request replacement warning stickers or placards from Nautilus customer service.
- Do not try to change the design or functionality of the machine being serviced as this can adversely effect user safety and will void the warranty.
- Do not use the machine until all shrouds, instructions, warning labels and correct functionality have been verified and tested for correct performance.

### Tools Required (not included)

#2 Phillips screwdriver

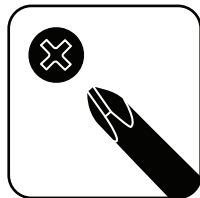

(2) 17mm wrenches

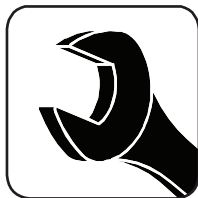

Something to cut Zip-Ties

Replacement Zip-Tie



**Note:** The Bowflex® BXT116 is used in the following images. The procedure is the same for the BXT216 model.

1. With power supplied to the machine and it turned on, adjust the Walking Deck Incline to a setting of '6'. To adjust, push the '6' Pre-Set Incline button, and then the Confirm Incline button. Allow the Walking Deck to adjust to the new incline height.

2. Unplug the power cord from the machine and wait 5 minutes. Place the power cord in a secure location.

**⚠ DANGER** To reduce the risk of electrical shock or unsupervised usage of the equipment, always unplug the power cord from the wall outlet and wait 5 minutes before cleaning, maintaining or repairing this machine. Place the power cord in a secure location.

3. Using a #2 Phillips screwdriver, remove the screw (indicated by ovals) from each of the Base Shrouds.

4. Remove the Base Shrouds from the machine.

5. Using a #2 Phillips screwdriver, remove the 10 indicated screws that secure the Motor Cover.

**Note:** There are 2 screws that secure the Motor Cover from the underside of the machine (see image to the right).

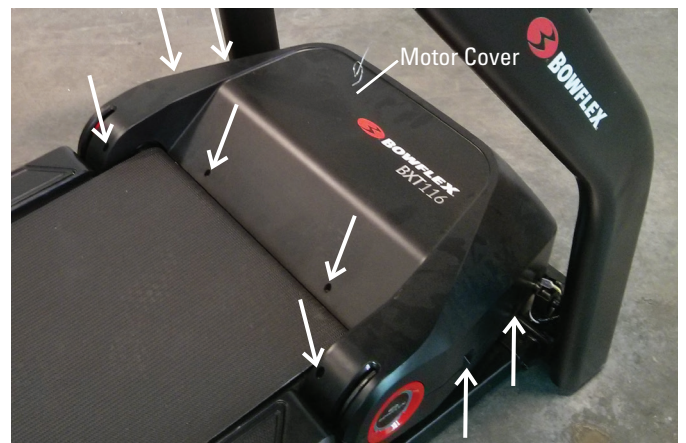

6. Disconnect the Lower I/O and Grounding Cables.

7. Cut the Zip-Tie that secures the Cables to the Frame Assembly.



8. Gently release the front snaps (indicated by ovals) that secure the Motor Cover and pivot it back toward the walking belt until it releases. Remove from the machine.



9. Make sure there is sufficient space to tilt the machine onto the left side.

**!** Keep a minimum clearance behind the machine of 79" (2 m) and 24" (0.6 m) on each side. This is the recommended safe distance for access, movement and emergency dismounts from the machine.

**Note:** THE FOLLOWING STEP MAY REQUIRE A SECOND PERSON.

10. Tilt the machine onto the left side.

**!** Be sure the area is clear around the machine before tilting it. Do not grasp the Walking Belt since it can abruptly move.

The machine may be moved by one or more persons depending on their physical abilities and capacities. Make sure that you and others are all physically fit and able to move the machine safely.

11. Using two 17mm wrenches, remove the indicated hardware (with arrow) from the Incline Motor Assembly.

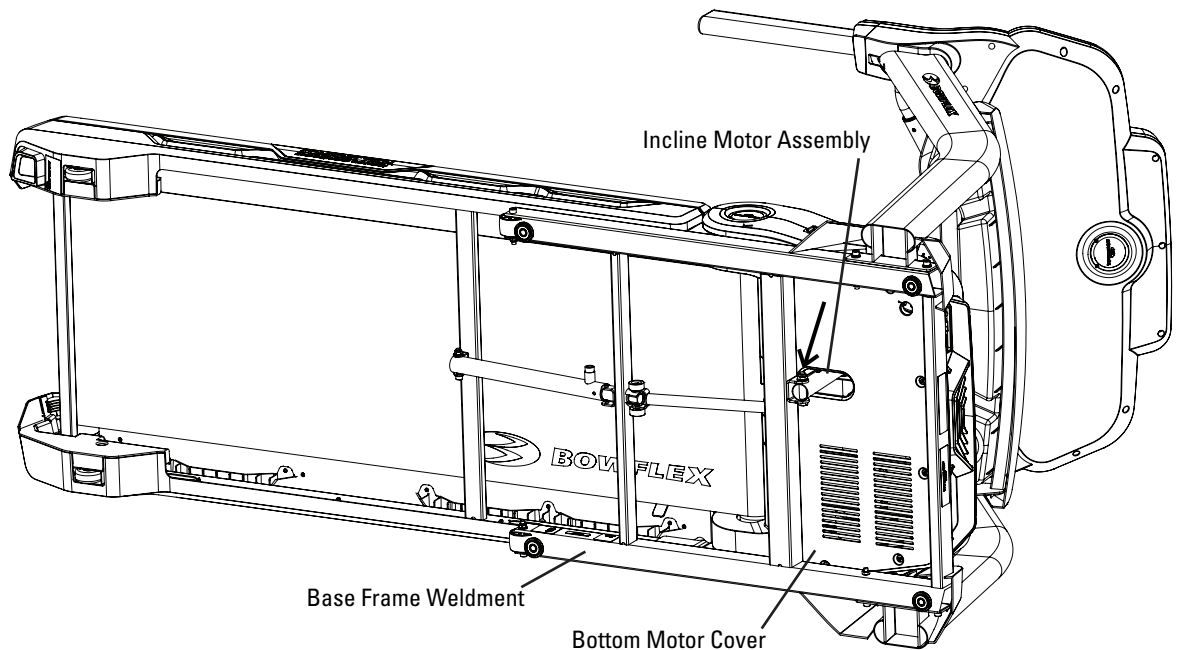

12. Using a #2 Phillips screwdriver, remove the 10 indicated screws from the Bottom Motor Cover.

**Note:** The Base Frame Weldment has been removed for clarity.

13. Remove the old Bottom Motor Cover and attach the new Bottom Motor Cover.

**Note:** Be sure to route the cables from the Base Assembly through the new Bottom Motor Cover.

14. Using two 17mm wrenches in the Motor Compartment, reattach the hardware to the Incline Motor Assembly.

15. Make sure there is sufficient space to tilt the machine back upright and that the area is clear.

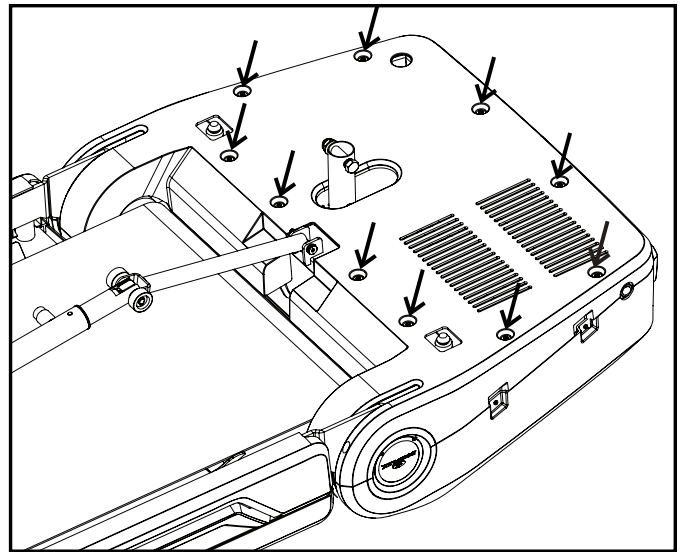

Base Frame Weldment removed for clarity.

**!** This step requires two people. Be sure there is adequate clearance for the raised deck. Some components of the equipment can be heavy or awkward. Enlist the service of a second person when you do maintenance steps involving these components. Do not try to do heavy or awkward steps on your own.

16. Re-install and connect all remaining parts that were removed in reverse order.

17. Final Inspection  
Inspect your machine to ensure that all hardware is tight and components are properly assembled.

**!** Do not use until the machine has been fully assembled and inspected for correct performance in accordance with the Owner's Manual.



**NOTICE:** This document provides instructions for the replacement of the Circuit Breaker on the Bowflex® BXT116 / BXT216 Treadmills.

**If you need assistance, please call Bowflex Customer Service at 1-800-605-3369.**

 **This icon means a potentially hazardous situation which, if not avoided, could result in death or serious injury. Read and understand all Warnings on this machine.**

Nautilus, Inc., www.NautilusInc.com - Customer Service: North America (800) 605-3369, csnl@nautilus.com | outside U.S. www.nautilusinternational.com | Printed in China | © 2017 Nautilus, Inc. | ® indicates trademarks registered in the United States. These marks may be registered in other nations or otherwise protected by common law. Bowflex and the B logo are trademarks owned by or licensed to Nautilus, Inc.

### Important Safety Instructions - Before servicing or using this equipment, obey the following warnings:

 **This icon means a potentially hazardous situation which, if not avoided, could result in death or serious injury. Read and understand all Warnings on this machine.**

**DANGER** **To reduce the risk of electrical shock or unsupervised usage of the equipment, always unplug the power cord from the wall outlet and wait 5 minutes before cleaning, maintaining or repairing this machine. Place the power cord in a secure location.**

- Read and understand the Part Replacement Procedure before working on the machine. Failure to obey the instructions and safety warnings could cause injury to the service technician or bystanders.
- Keep bystanders, children and pets away from the product being serviced at all times.
- Make sure that the repair is done in an appropriate work space away from foot traffic and exposure to bystanders.
- Disconnect all power and allow to sit for 5 minutes before you service this machine.
- Some components of the equipment can be heavy or awkward. Enlist the service of a second person when you do maintenance steps involving these components. Do not try to do heavy or awkward steps on your own.
- If replacement parts are necessary, use only genuine Nautilus replacement parts and hardware. Failure to use genuine replacement parts can cause a risk to users, keep the machine from operating correctly and will void the warranty.
- Be sure that all warning stickers and instructional placards applied to the product stay present and in good condition when doing maintenance or replacing components. If necessary request replacement warning stickers or placards from Nautilus customer service.
- Do not try to change the design or functionality of the machine being serviced as this can adversely effect user safety and will void the warranty.
- Do not use the machine until all shrouds, instructions, warning labels and correct functionality have been verified and tested for correct performance.

### Tools Required (not included)

#2 Phillips screwdriver (short)

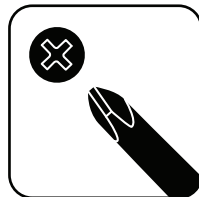

**Note:** The Bowflex® BXT116 is used in the following images. The procedure is the same for the BXT216 model.

1. With power supplied to the machine and it turned on, adjust the Walking Deck Incline to a setting of '6'. To adjust, push the '6' Pre-Set Incline button, and then the Confirm Incline button. Allow the Walking Deck to adjust to the new incline height.

2. Unplug the power cord from the machine and wait 5 minutes. Place the power cord in a secure location.

**⚠ DANGER** To reduce the risk of electrical shock or unsupervised usage of the equipment, always unplug the power cord from the wall outlet and wait 5 minutes before cleaning, maintaining or repairing this machine. Place the power cord in a secure location.

3. Using a #2 Phillips screwdriver, remove the screw (indicated by ovals) from each of the Base Shrouds.

4. Remove the Base Shrouds from the machine.

5. Using a #2 Phillips screwdriver, remove the 10 indicated screws that secure the Motor Cover.

**Note:** There are 2 screws that secure the Motor Cover from the underside of the machine (see image to the right).

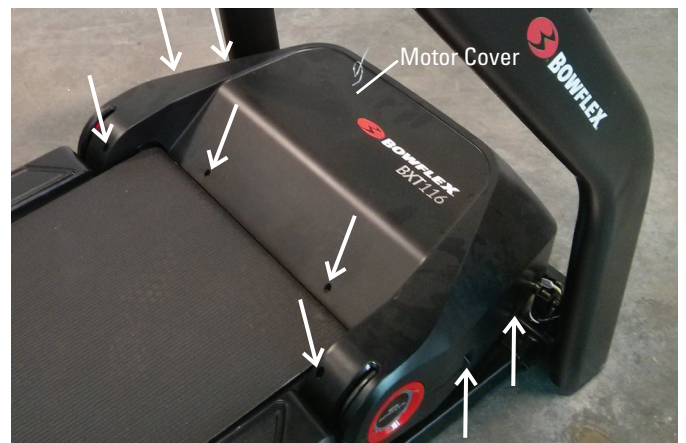

6. Gently release the front snaps (indicated by ovals) that secure the Motor Cover and pivot it back toward the walking belt until it releases. Remove from the machine.



7. Using a #2 Phillips screwdriver, remove the 2 indicated screws from the Motor Control Board Cover. Lift and remove the Motor Control Board Cover.

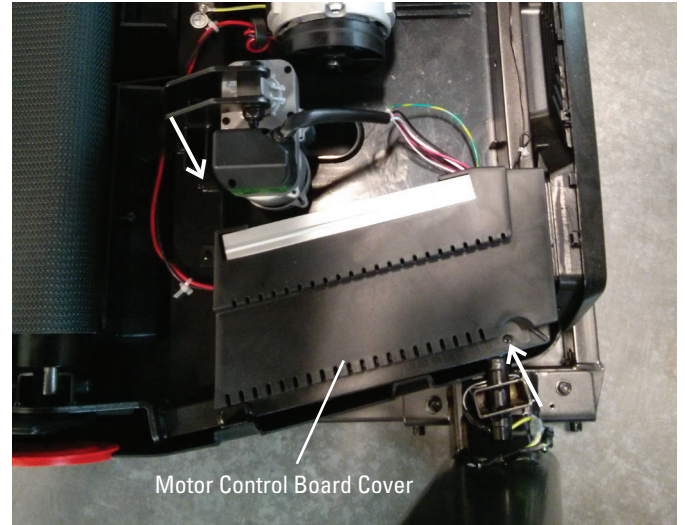

8. From the front, remove the Securing Ring from the Circuit Breaker by rotating it counter-clockwise. Remove the Circuit Breaker from the Frame.

9. Remove the connectors and attach them to the new Circuit Breaker.

10. Insert the new Circuit Breaker into the Frame and install the Securing Ring.

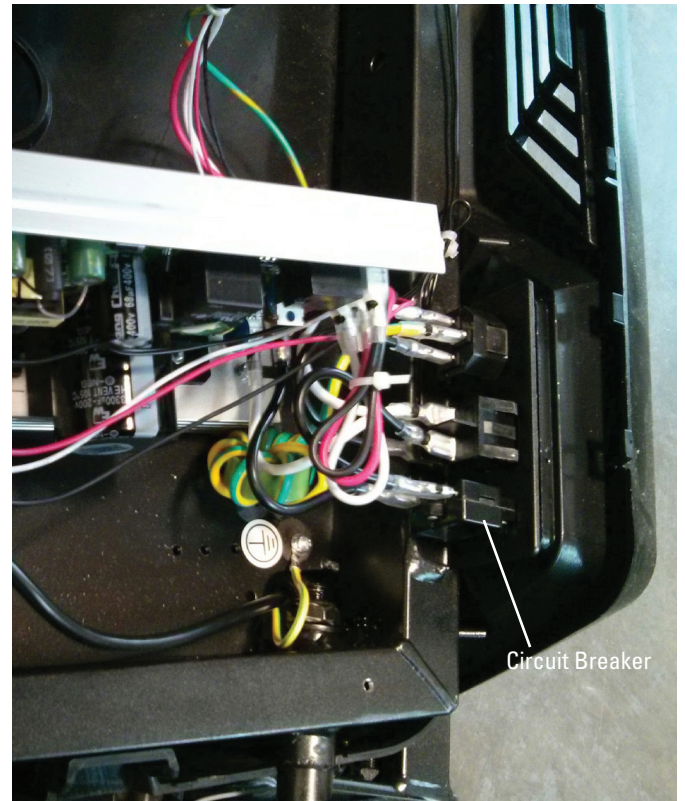

11. Re-install all remaining parts that were removed in reverse order.

12. Final Inspection

Inspect your machine to ensure that all hardware is tight and components are properly assembled.



**Do not use until the machine has been fully assembled and inspected for correct performance in accordance with the Owner's Manual.**

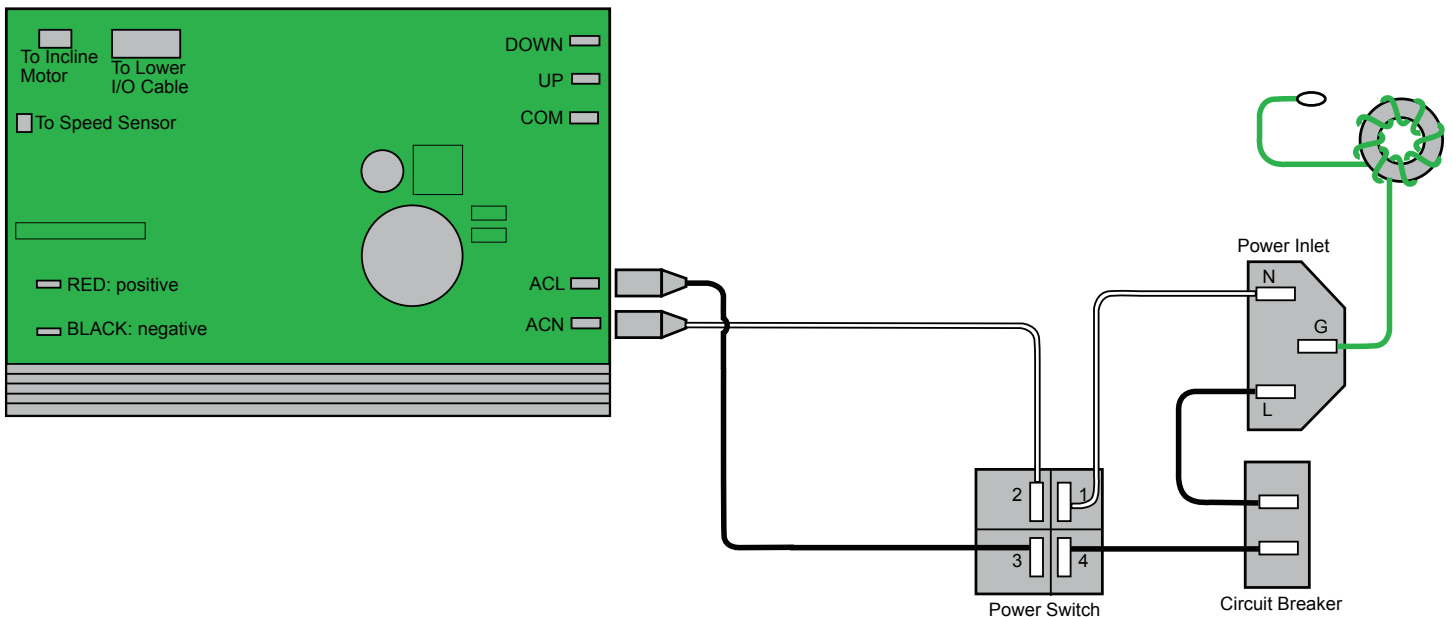
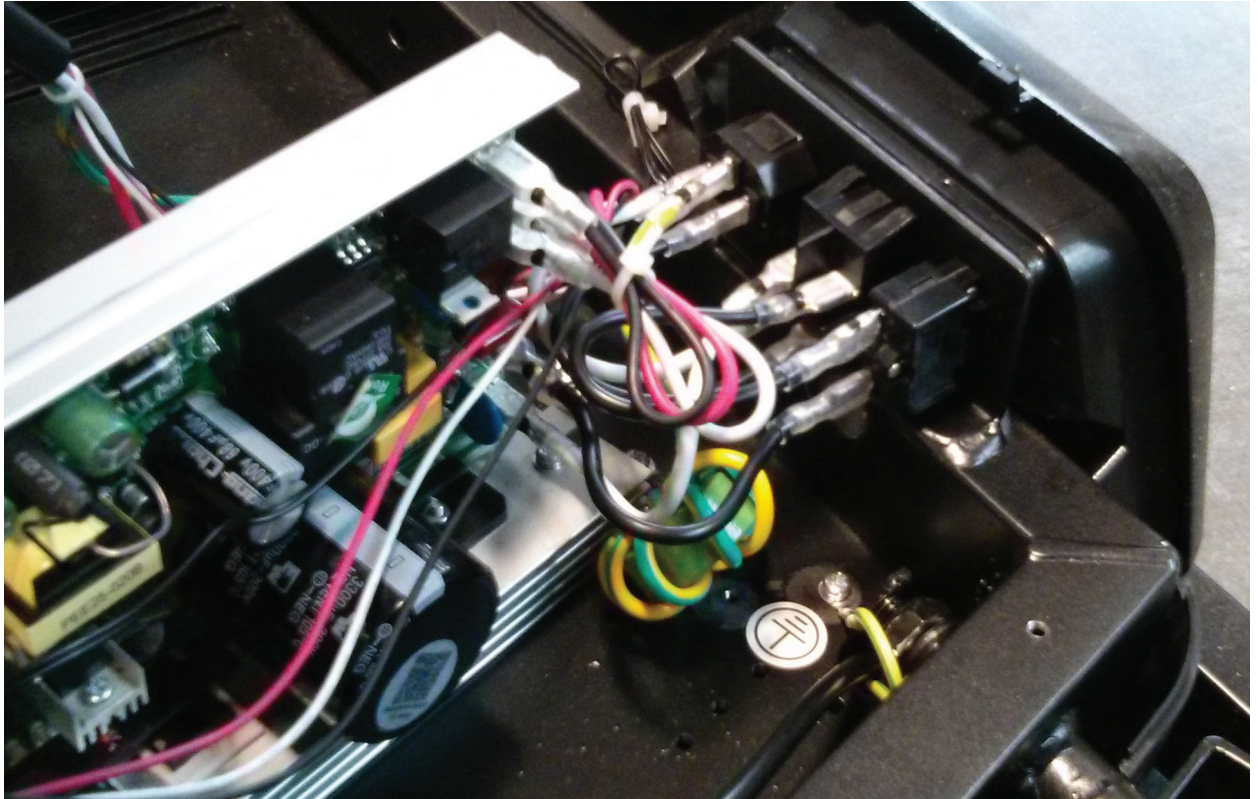

**NOTICE:** This document provides instructions for the replacement of the Console Assembly on the Bowflex® BXT116 Treadmill.

**If you need assistance, please call Bowflex Customer Service at 1-800-605-3369.**

 **This icon means a potentially hazardous situation which, if not avoided, could result in death or serious injury. Read and understand all Warnings on this machine.**

Nautilus, Inc., (800) NAUTILUS / (800) 628-8458, www.NautilusInc.com - Customer Service: North America (800) 605-3369, csnl@snautilus.com | outside U.S. www.nautilusinternational.com | Printed in China | © 2017 Nautilus, Inc. | ® indicates trademarks registered in the United States. These marks may be registered in other nations or otherwise protected by common law. Bowflex and the B logo are trademarks owned by or licensed to Nautilus, Inc.

### Important Safety Instructions - Before servicing or using this equipment, obey the following warnings:

 **This icon means a potentially hazardous situation which, if not avoided, could result in death or serious injury. Read and understand all Warnings on this machine.**

**⚠ DANGER** To reduce the risk of electrical shock or unsupervised usage of the equipment, always unplug the power cord from the wall outlet and wait 5 minutes before cleaning, maintaining or repairing this machine. Place the power cord in a secure location.

- Read and understand the Part Replacement Procedure before working on the machine. Failure to obey the instructions and safety warnings could cause injury to the service technician or bystanders.
- Keep bystanders, children and pets away from the product being serviced at all times.
- Make sure that the repair is done in an appropriate work space away from foot traffic and exposure to bystanders.
- Disconnect all power and allow to sit for 5 minutes before you service this machine.
- Some components of the equipment can be heavy or awkward. Enlist the service of a second person when you do maintenance steps involving these components. Do not try to do heavy or awkward steps on your own.
- If replacement parts are necessary, use only genuine Nautilus replacement parts and hardware. Failure to use genuine replacement parts can cause a risk to users, keep the machine from operating correctly and will void the warranty.
- Be sure that all warning stickers and instructional placards applied to the product stay present and in good condition when doing maintenance or replacing components. If necessary request replacement warning stickers or placards from Nautilus customer service.
- Do not try to change the design or functionality of the machine being serviced as this can adversely effect user safety and will void the warranty.
- Do not use the machine until all shrouds, instructions, warning labels and correct functionality have been verified and tested for correct performance.

### Tools Required (not included)

#2 Phillips screwdriver

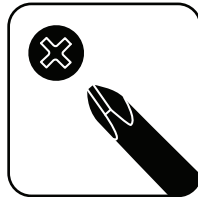

Standard screwdriver



6mm hex wrench



A Zip-Tie, rubber band or piece of wire to restrict Console Cable from falling into Right Upright



**⚠ DANGER** To reduce the risk of electrical shock or unsupervised usage of the equipment, always unplug the power cord from the wall outlet and wait 5 minutes before cleaning, maintaining or repairing this machine. Place the power cord in a secure location.

1. Unplug the power cord from the machine and wait 5 minutes. Place the power cord in a secure location.

2. Using a standard screwdriver, gently lift and release the Junction Cover End Caps from the Console Assembly.

3. Remove the Junction Cover End Caps from the Console Assembly.



4. Using a #2 Phillips screwdriver, remove the 4 indicated screws (by arrows) from Lower Junction Covers.

5. Gently release the snaps (indicated by ovals, two on each side) that secure the Upper and Lower Junction Covers and remove the Upper Junction Covers.



6. Gently pull out the Input/Output (I/O) and Grounding Cables from the Right Upright, and disconnect them. Do not allow the Cables to fall into the Right Upright. Secure them with A Zip-Tie, rubber band or piece of wire.

**Note:** Do not crimp the Cables.



7. Using a 6mm hex wrench, remove the 8 screws that secure the Console Assembly from the Right and Left Uprights.

**Note:** To assist with re-assembly, be sure to note that the curved washers are used facing the rear of the machine.

8. Fully remove the Console and Handlebar Assembly from the Uprights.



9. Using a 6mm hex wrench, remove the hardware from the Side Handlebars.

**Note:** To assist with re-assembly, be sure to note that the curved washers are used facing downward.

10. Remove the Side Handlebars from the old Console Assembly, and attach to the new Console Assembly.

11. With the new Console and Handlebar Assembly, connect the cables and attach it to the Uprights.

**Note:** This step may take two people to safely hold the Console and Handlebar Assembly and connect the Cables. Do not crimp the Cables.



12. Re-install all remaining parts that were removed in reverse order.

13. Final Inspection

Inspect your machine to ensure that all hardware is tight and components are properly assembled.



**Do not use until the machine has been fully assembled and inspected for correct performance in accordance with the**

**Owner's Manual.**

**NOTICE:** This document provides instructions to replace the Deck Release Assembly on the Bowflex® BXT116 Treadmill.

If you need assistance, please call Bowflex Customer Service at 1-800-605-3369.

This icon means a potentially hazardous situation which, if not avoided, could result in death or serious injury. Read and understand all Warnings on this machine.

Nautilus, Inc., (800) NAUTILUS / (800) 628-8458, www.NautilusInc.com - Customer Service: North America (800) 605-3369, csnl@nautilus.com | outside U.S. www.nautilusinternational.com | Printed in China | © 2017 Nautilus, Inc. | ® indicates trademarks registered in the United States. These marks may be registered in other nations or otherwise protected by common law. Bowflex and the B logo are trademarks owned by or licensed to Nautilus, Inc.

### Important Safety Instructions - Before servicing or using this equipment, obey the following warnings:

This icon means a potentially hazardous situation which, if not avoided, could result in death or serious injury. Read and understand all Warnings on this machine.

**⚠ DANGER** To reduce the risk of electrical shock or unsupervised usage of the equipment, always unplug the power cord from the wall outlet and wait 5 minutes before cleaning, maintaining or repairing this machine. Place the power cord in a secure location.

- Read and understand the Part Replacement Procedure before working on the machine. Failure to obey the instructions and safety warnings could cause injury to the service technician or bystanders.
- Keep bystanders, children and pets away from the product being serviced at all times.
- Make sure that the repair is done in an appropriate work space away from foot traffic and exposure to bystanders.
- Disconnect all power and allow to sit for 5 minutes before you service this machine.
- Some components of the equipment can be heavy or awkward. Enlist the service of a second person when you do maintenance steps involving these components. Do not try to do heavy or awkward steps on your own.
- If replacement parts are necessary, use only genuine Nautilus replacement parts and hardware. Failure to use genuine replacement parts can cause a risk to users, keep the machine from operating correctly and will void the warranty.
- Be sure that all warning stickers and instructional placards applied to the product stay present and in good condition when doing maintenance or replacing components. If necessary request replacement warning stickers or placards from Nautilus customer service.
- Do not try to change the design or functionality of the machine being serviced as this can adversely effect user safety and will void the warranty.
- Do not use the machine until all shrouds, instructions, warning labels and correct functionality have been verified and tested for correct performance.

### Tools Required (not included)

10mm wrench  
14mm wrench

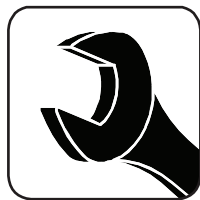

Wire Cutters

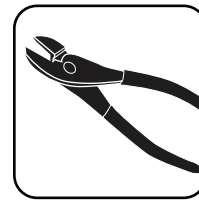

#2 Phillips screwdriver



(2) Replacement Zip-Ties





**⚠ DANGER** To reduce the risk of electrical shock or unsupervised usage of the equipment, always unplug the power cord from the wall outlet and wait 5 minutes before cleaning, maintaining or repairing this machine. Place the power cord in a secure location.

1. Unplug the power cord from the machine and wait 5 minutes. Place the power cord in a secure location.

2. Make sure that there is safe clearance around, on and above the treadmill. Make sure there is no object to spill or cause blockage from the fully folded position.

**⚠** Be sure there is adequate height clearance for the raised deck.

3. Using the support bar found below the rear of the walking belt, push the Deck Release Handle and lift the walking deck fully upward and engage the hydraulic lift. Be sure that the hydraulic lift is correctly locked in place. You will hear an audible click when the hydraulic lift shifts into the locked position.

**⚠** Use proper safety precautions and lifting techniques. Bend your knees and elbows, keep your back straight and pull up equally with both arms. Straighten your legs to lift. Make sure that your own physical strength is capable of lifting the walking deck until it engages the locking mechanism. Use a second person if necessary.

Do not use the walking belt or rear roller to lift the treadmill. These parts do not lock in place and can abruptly move. Injury to you or damage to the machine can occur.

4. Make sure that the locking mechanism is engaged. Carefully pull back on the walking deck and make sure that it does not move. When you do this, keep clear of movement path in case the treadmill lock is not properly engaged.

**⚠** Do not lean against the treadmill when it is folded. Do not put items on it that could cause it to become unstable or fall.

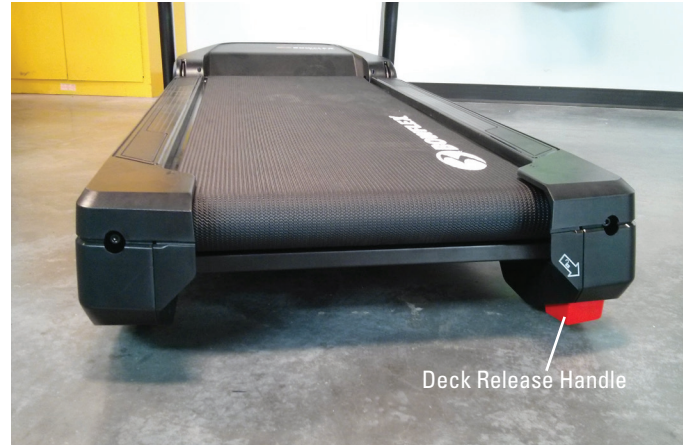

5. Using a #2 Phillips screwdriver, remove the two indicated screws from the Rear Roller Cover.

6. Remove the Rear Roller Cover noting how it attaches for re-assembly.



7. With the Right Rear Roller Cover removed, the spring that connects to the Deck Release Handle can be seen. Note the orientation of the spring to assist with re-assembly.

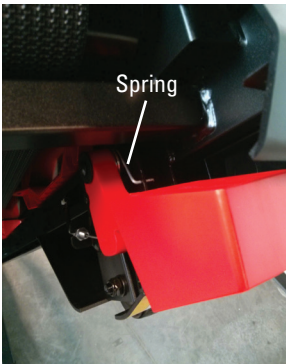

8. Using a pair of wire cutters, cut the zip-ties (indicated by ovals) that secure the cable to the Frame.



9. Make sure that there is safe clearance around, above, and to one side of the treadmill. Tilt the machine onto the side being sure not to grasp the Console.

**!** A second person is required to assist with the tilting of the machine. Do not tilt the machine unless the walking deck is in the folded, locked position. Be sure there is adequate clearance for the raised deck. Some components of the equipment can be heavy or awkward. Enlist the service of a second person when you do maintenance steps involving these components. Do not try to do heavy or awkward steps on your own.



**⚠ DANGER** The following images show the machine upright, and not fully resting on its side. The machine must be on its side to safely complete the following steps.

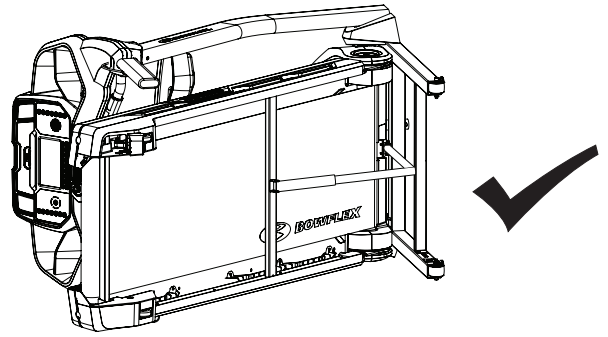

10. Using a 10mm wrench, loosen the locking nut for the Release Cable (indicated by arrow).

11. Using a 14mm wrench, disconnect the securing nut and remove the Release Cable Assembly from the Lift Shock.



12. Using a #2 Phillips screwdriver, remove the indicated screw and the Deck Release Handle Assembly.

13. Route the new cable through the frame, and attach the new Deck Release Handle Assembly with a #2 Phillips screwdriver.

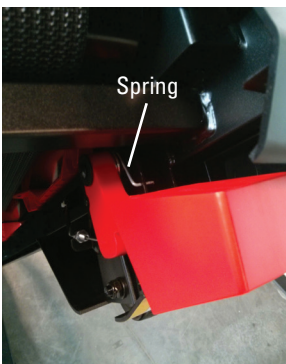

**Note:** Make sure the spring that connects to the Deck Release Handle is properly oriented during re-assembly.

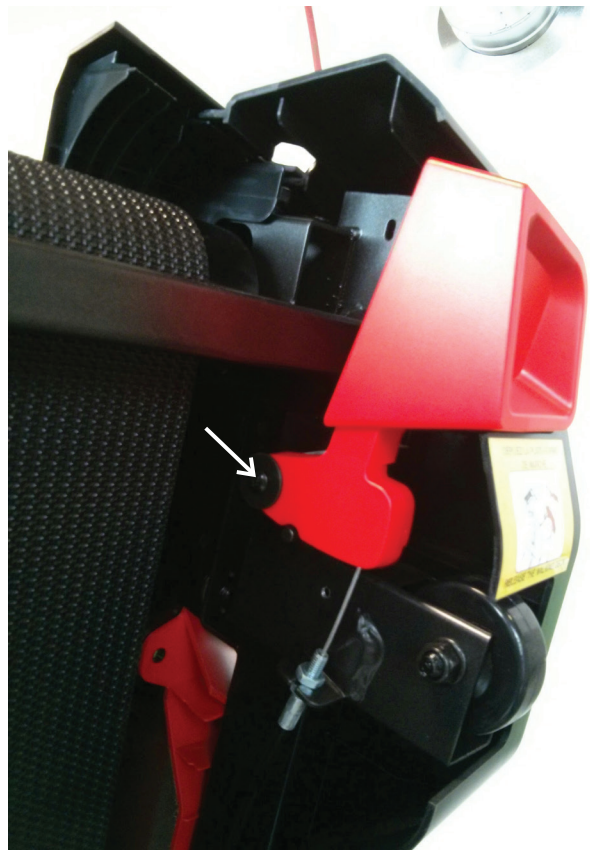

14. Using a 10mm and a 14mm wrench, re-connect the cable to the Lift Cylinder.

15. Secure the new cable to the Frame with the replacement Zip-Ties.

16. Using a #2 Phillips screwdriver, secure the Rear Roller Cover..

17. Make sure there is sufficient space to lower the walking deck.

 **Keep a minimum clearance behind the machine of 79" (2 m) and 24" (0.6 m) on each side. This is the recommended safe distance for access, movement and emergency dismounts from the machine.**

18. Make sure there is no object on or around the treadmill to spill or cause blockage from the fully unfolded position.

19. Slightly push the walking deck forward toward the console, and then push the Deck Release Handle until the locking tube releases and you can pull the walking deck away from the console. Hold up the rear of the walking deck, and move to the side of the machine.

 **Keep clear of the movement path of the walking deck.**

20. The hydraulic lift is set up to drop gradually. Hold onto the walking deck until approximately 2/3 of the movement down. Make sure that you use proper lifting technique; bend your knees and keep your back straight. Lower the weight with your legs. Be aware that the walking deck can possibly drop quickly in the last part of the movement.

21. Final Inspection

Inspect your machine to ensure that all hardware is tight and components are properly assembled.

 **Do not use until the machine has been fully assembled and inspected for correct performance in accordance with the Owner's Manual.**

**NOTICE:** This document provides instructions to replace the Deck Suspension on the Bowflex® BXT116 Treadmill.

**If you need assistance, please call Bowflex Customer Service at 1-800-605-3369.**

 **This icon means a potentially hazardous situation which, if not avoided, could result in death or serious injury. Read and understand all Warnings on this machine.**

Nautilus, Inc., (800) NAUTILUS / (800) 628-8458, www.NautilusInc.com - Customer Service: North America (800) 605-3369, csnl@nautilus.com | outside U.S. www.nautilusinternational.com | Printed in China | © 2017 Nautilus, Inc. | ® indicates trademarks registered in the United States. These marks may be registered in other nations or otherwise protected by common law. Bowflex and the B logo are trademarks owned by or licensed to Nautilus, Inc.

### Important Safety Instructions - Before servicing or using this equipment, obey the following warnings:

 **This icon means a potentially hazardous situation which, if not avoided, could result in death or serious injury. Read and understand all Warnings on this machine.**

**⚠ DANGER** To reduce the risk of electrical shock or unsupervised usage of the equipment, always unplug the power cord from the wall outlet and wait 5 minutes before cleaning, maintaining or repairing this machine. Place the power cord in a secure location.

- Read and understand the Part Replacement Procedure before working on the machine. Failure to obey the instructions and safety warnings could cause injury to the service technician or bystanders.
- Keep bystanders, children and pets away from the product being serviced at all times.
- Make sure that the repair is done in an appropriate work space away from foot traffic and exposure to bystanders.
- Disconnect all power and allow to sit for 5 minutes before you service this machine.
- Some components of the equipment can be heavy or awkward. Enlist the service of a second person when you do maintenance steps involving these components. Do not try to do heavy or awkward steps on your own.
- If replacement parts are necessary, use only genuine Nautilus replacement parts and hardware. Failure to use genuine replacement parts can cause a risk to users, keep the machine from operating correctly and will void the warranty.
- Be sure that all warning stickers and instructional placards applied to the product stay present and in good condition when doing maintenance or replacing components. If necessary request replacement warning stickers or placards from Nautilus customer service.
- Do not try to change the design or functionality of the machine being serviced as this can adversely effect user safety and will void the warranty.
- Do not use the machine until all shrouds, instructions, warning labels and correct functionality have been verified and tested for correct performance.

### Tools Required (not included)

#2 Phillips screwdriver

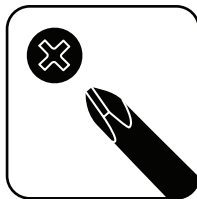

**⚠ DANGER** To reduce the risk of electrical shock or unsupervised usage of the equipment, always unplug the power cord from the wall outlet and wait 5 minutes before cleaning, maintaining or repairing this machine. Place the power cord in a secure location.

1. Unplug the power cord from the machine and wait 5 minutes. Place the power cord in a secure location.

2. Make sure that there is safe clearance around, on and above the treadmill. Make sure there is no object to spill or cause blockage from the fully folded position.

**⚠** Be sure there is adequate height clearance for the raised deck.

3. Using the support bar found below the rear of the walking belt, push the Deck Release Handle and lift the walking deck fully upward and engage the hydraulic lift. Be sure that the hydraulic lift is correctly locked in place. You will hear an audible click when the hydraulic lift shifts into the locked position.

**⚠** Use proper safety precautions and lifting techniques. Bend your knees and elbows, keep your back straight and pull up equally with both arms. Straighten your legs to lift. Make sure that your own physical strength is capable of lifting the walking deck until it engages the locking mechanism. Use a second person if necessary.

Do not use the walking belt or rear roller to lift the treadmill. These parts do not lock in place and can abruptly move. Injury to you or damage to the machine can occur.

4. Make sure that the locking mechanism is engaged. Carefully pull back on the walking deck and make sure that it does not move. When you do this, keep clear of movement path in case the treadmill lock is not properly engaged.

**⚠** Do not lean against the treadmill when it is folded. Do not put items on it that could cause it to become unstable or fall.

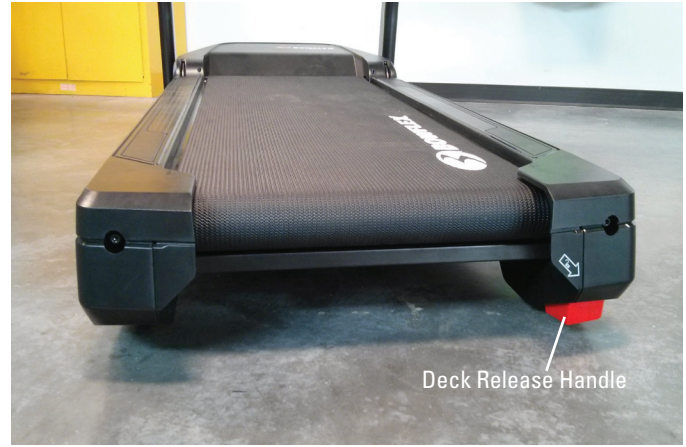

5. Using a #2 Phillips screwdriver, remove the two indicated screws from the Rear Roller Cover.

6. Remove the Rear Roller Cover noting how it attaches for re-assembly.

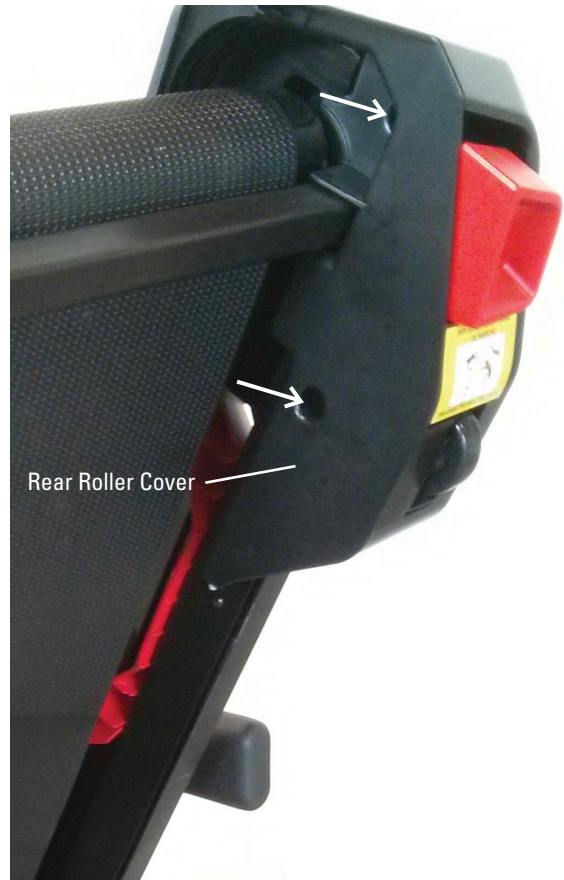

7. Using a #2 Phillips screwdriver, remove the 5 indicated screws from the Deck Suspension Inserts.

8. Remove the old Deck Suspension Inserts and attach the new Inserts.

9. Re-install all parts that were removed in reverse order.

10. Make sure there is sufficient space to lower the walking deck.

**⚠ Keep a minimum clearance behind the machine of 79" (2 m) and 24" (0.6 m) on each side. This is the recommended safe distance for access, movement and emergency dismounts from the machine.**

11. Make sure there is no object on or around the treadmill to spill or cause blockage from the fully unfolded position.

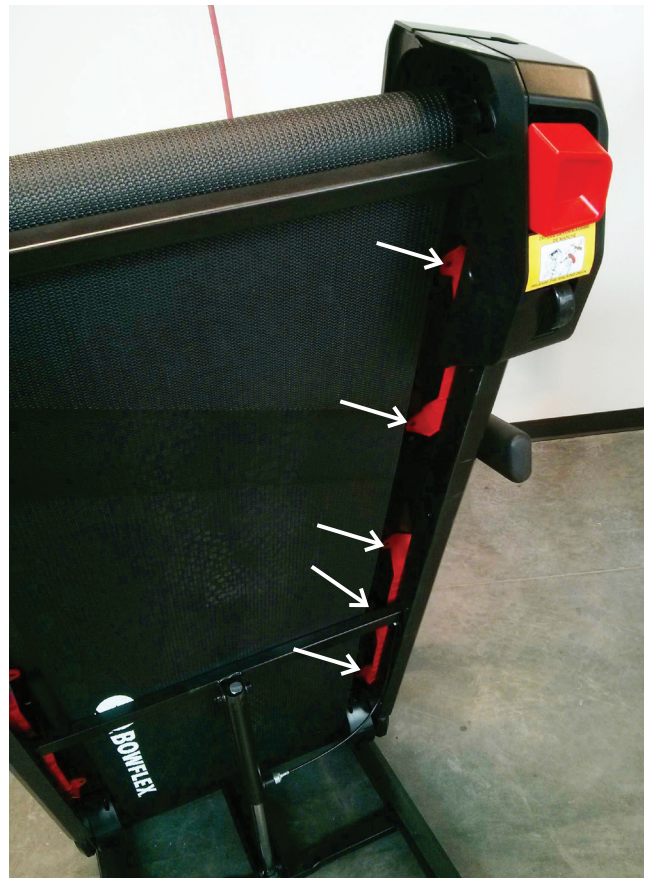



12. Slightly push the walking deck forward toward the console, and then push the Deck Release Handle until the locking tube releases and you can pull the walking deck away from the console. Hold up the rear of the walking deck, and move to the side of the machine.



**Keep clear of the movement path of the walking deck.**

13. The hydraulic lift is set up to drop gradually. Hold onto the walking deck until approximately 2/3 of the movement down. Make sure that you use proper lifting technique; bend your knees and keep your back straight. Lower the weight with your legs. Be aware that the walking deck can possibly drop quickly in the last part of the movement.

#### 14. Final Inspection

Inspect your machine to ensure that all hardware is tight and components are properly assembled.



**Do not use until the machine has been fully assembled and inspected for correct performance in accordance with the Owner's Manual.**

**NOTICE:** This document provides instructions to replace the Deck Wheel on the Bowflex® BXT116 Treadmill.

**If you need assistance, please call Bowflex Customer Service at 1-800-605-3369.**

 **This icon means a potentially hazardous situation which, if not avoided, could result in death or serious injury. Read and understand all Warnings on this machine.**

Nautilus, Inc., www.NautilusInc.com - Customer Service: North America (800) 605-3369, csnl@nautilus.com | outside U.S. www.nautilusinternational.com | Printed in China | © 2017 Nautilus, Inc. | ® indicates trademarks registered in the United States. These marks may be registered in other nations or otherwise protected by common law. Bowflex and the B logo are trademarks owned by or licensed to Nautilus, Inc.

### Important Safety Instructions - Before servicing or using this equipment, obey the following warnings:

 **This icon means a potentially hazardous situation which, if not avoided, could result in death or serious injury. Read and understand all Warnings on this machine.**

**DANGER** **To reduce the risk of electrical shock or unsupervised usage of the equipment, always unplug the power cord from the wall outlet and wait 5 minutes before cleaning, maintaining or repairing this machine. Place the power cord in a secure location.**

- Read and understand the Part Replacement Procedure before working on the machine. Failure to obey the instructions and safety warnings could cause injury to the service technician or bystanders.
- Keep bystanders, children and pets away from the product being serviced at all times.
- Make sure that the repair is done in an appropriate work space away from foot traffic and exposure to bystanders.
- Disconnect all power and allow to sit for 5 minutes before you service this machine.
- Some components of the equipment can be heavy or awkward. Enlist the service of a second person when you do maintenance steps involving these components. Do not try to do heavy or awkward steps on your own.
- If replacement parts are necessary, use only genuine Nautilus replacement parts and hardware. Failure to use genuine replacement parts can cause a risk to users, keep the machine from operating correctly and will void the warranty.
- Be sure that all warning stickers and instructional placards applied to the product stay present and in good condition when doing maintenance or replacing components. If necessary request replacement warning stickers or placards from Nautilus customer service.
- Do not try to change the design or functionality of the machine being serviced as this can adversely effect user safety and will void the warranty.
- Do not use the machine until all shrouds, instructions, warning labels and correct functionality have been verified and tested for correct performance.

#### Tools Required (not included)

#2 Phillips screwdriver

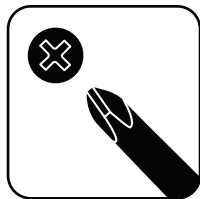

13mm wrench



6mm hex wrench



**⚠ DANGER** To reduce the risk of electrical shock or unsupervised usage of the equipment, always unplug the power cord from the wall outlet and wait 5 minutes before cleaning, maintaining or repairing this machine. Place the power cord in a secure location.

1. Unplug the power cord from the machine and wait 5 minutes. Place the power cord in a secure location.

2. Make sure that there is safe clearance around, on and above the treadmill. Make sure there is no object to spill or cause blockage from the fully folded position.

**⚠** Be sure there is adequate height clearance for the raised deck.

3. Using the support bar found below the rear of the walking belt, push the Deck Release Handle and lift the walking deck fully upward and engage the hydraulic lift. Be sure that the hydraulic lift is correctly locked in place. You will hear an audible click when the hydraulic lift shifts into the locked position.

**⚠** Use proper safety precautions and lifting techniques. Bend your knees and elbows, keep your back straight and pull up equally with both arms. Straighten your legs to lift. Make sure that your own physical strength is capable of lifting the walking deck until it engages the locking mechanism. Use a second person if necessary.

**Do not use the walking belt or rear roller to lift the treadmill. These parts do not lock in place and can abruptly move. Injury to you or damage to the machine can occur.**

4. Make sure that the locking mechanism is engaged. Carefully pull back on the walking deck and make sure that it does not move. When you do this, keep clear of movement path in case the treadmill lock is not properly engaged.

**⚠** Do not lean against the treadmill when it is folded. Do not put items on it that could cause it to become unstable or fall.

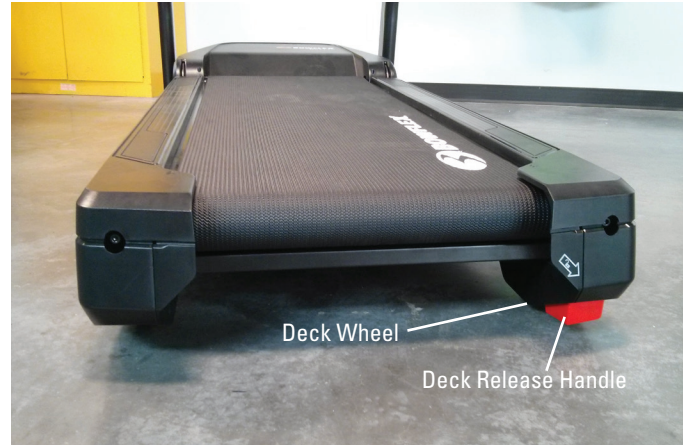

5. Using a #2 Phillips screwdriver, remove the two indicated screws from the Rear Roller Cover.

6. Remove the Rear Roller Cover noting how it attaches for re-assembly.



7. Using a #2 Phillips screwdriver, remove the 4 indicated screws from the Lower Side Rail.

8. Remove the Lower Side Rail noting how it attaches for re-assembly.



9. Using a 13mm wrench and a 6mm hex wrench, remove the hardware indicated from the Deck Wheel.

10. Re-install all parts that were removed in reverse order.

11. Make sure there is sufficient space to lower the walking deck.

**!** Keep a minimum clearance behind the machine of 79" (2 m) and 24" (0.6 m) on each side. This is the recommended safe distance for access, movement and emergency dismounts from the machine.

12. Make sure there is no object on or around the treadmill to spill or cause blockage from the fully unfolded position.

13. Slightly push the walking deck forward toward the console, and then push the Deck Release Handle until the locking tube releases and you can pull the walking deck away from the console. Hold up the rear of the walking deck, and move to the side of the machine.

**!** Keep clear of the movement path of the walking deck.

14. The hydraulic lift is set up to drop gradually. Hold onto the walking deck until approximately 2/3 of the movement down. Make sure that you use proper lifting technique; bend your knees and keep your back straight. Lower the weight with your legs. Be aware that the walking deck can possibly drop quickly in the last part of the movement.

15. Final Inspection  
Inspect your machine to ensure that all hardware is tight and components are properly assembled.

**!** Do not use until the machine has been fully assembled and inspected for correct performance in accordance with the Owner's Manual.



**NOTICE:** This document provides instructions for the replacement of the Drive Belt on the Bowflex® BXT116 / BXT216 Treadmills.

**If you need assistance, please call Bowflex Customer Service at 1-800-605-3369.**

 **This icon means a potentially hazardous situation which, if not avoided, could result in death or serious injury. Read and understand all Warnings on this machine.**

Nautilus, Inc., www.NautilusInc.com - Customer Service: North America (800) 605-3369, csnl@nautilus.com | outside U.S. www.nautilusinternational.com | Printed in China | © 2017 Nautilus, Inc. | ® indicates trademarks registered in the United States. These marks may be registered in other nations or otherwise protected by common law. Bowflex and the B logo are trademarks owned by or licensed to Nautilus, Inc.

### Important Safety Instructions - Before servicing or using this equipment, obey the following warnings:

 **This icon means a potentially hazardous situation which, if not avoided, could result in death or serious injury. Read and understand all Warnings on this machine.**

**⚠ DANGER** **To reduce the risk of electrical shock or unsupervised usage of the equipment, always unplug the power cord from the wall outlet and wait 5 minutes before cleaning, maintaining or repairing this machine. Place the power cord in a secure location.**

- Read and understand the Part Replacement Procedure before working on the machine. Failure to obey the instructions and safety warnings could cause injury to the service technician or bystanders.
- Keep bystanders, children and pets away from the product being serviced at all times.
- Make sure that the repair is done in an appropriate work space away from foot traffic and exposure to bystanders.
- Disconnect all power and allow to sit for 5 minutes before you service this machine.
- Some components of the equipment can be heavy or awkward. Enlist the service of a second person when you do maintenance steps involving these components. Do not try to do heavy or awkward steps on your own.
- If replacement parts are necessary, use only genuine Nautilus replacement parts and hardware. Failure to use genuine replacement parts can cause a risk to users, keep the machine from operating correctly and will void the warranty.
- Be sure that all warning stickers and instructional placards applied to the product stay present and in good condition when doing maintenance or replacing components. If necessary request replacement warning stickers or placards from Nautilus customer service.
- Do not try to change the design or functionality of the machine being serviced as this can adversely effect user safety and will void the warranty.
- Do not use the machine until all shrouds, instructions, warning labels and correct functionality have been verified and tested for correct performance.

### Tools Required (not included)

#2 Phillips screwdriver

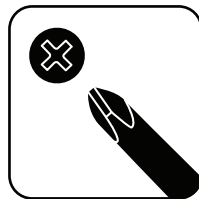

6mm Hex Wrench



13mm Wrench



**Note:** The Bowflex® BXT116 is used in the following images. The procedure is the same for the BXT216 model.

1. With power supplied to the machine and it turned on, adjust the Walking Deck Incline to a setting of '6'. To adjust, push the '6' Pre-Set Incline button, and then the Confirm Incline button. Allow the Walking Deck to adjust to the new incline height.

2. Unplug the power cord from the machine and wait 5 minutes. Place the power cord in a secure location.

**⚠ DANGER** To reduce the risk of electrical shock or unsupervised usage of the equipment, always unplug the power cord from the wall outlet and wait 5 minutes before cleaning, maintaining or repairing this machine. Place the power cord in a secure location.

3. Using a #2 Phillips screwdriver, remove the screw (indicated by ovals) from each of the Base Shrouds.

4. Remove the Base Shrouds from the machine.

5. Using a #2 Phillips screwdriver, remove the 10 indicated screws that secure the Motor Cover.

**Note:** There are 2 screws that secure the Motor Cover from the underside of the machine (see image to the right).

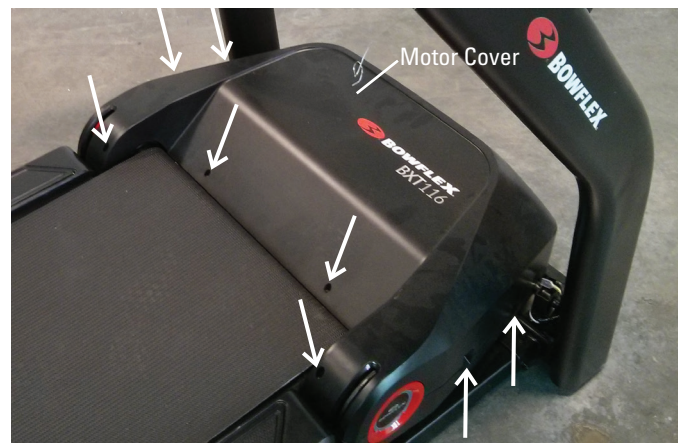

6. Gently release the front snaps (indicated by ovals) that secure the Motor Cover and pivot it back toward the walking belt until it releases. Remove from the machine.



7. Using a 6mm hex wrench, loosen the indicated screws (by arrow) on the Motor Mount.

8. Using a 13mm Open Ended Wrench, rotate the Belt Tensioner Screw enough to loosen the Drive Belt.

**Note:** To assist with reassembly, be sure to record the number of threads exposed before loosening.

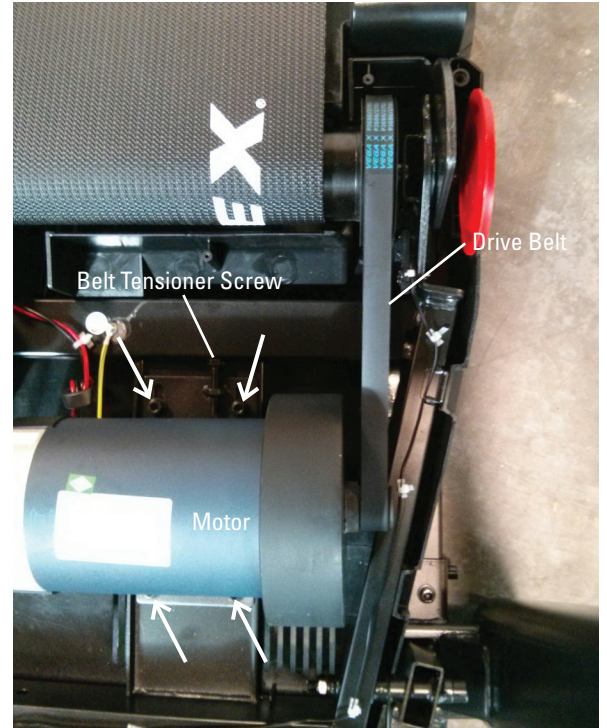

9. Using a 6mm hex wrench, remove the indicated screw from the Front Roller.

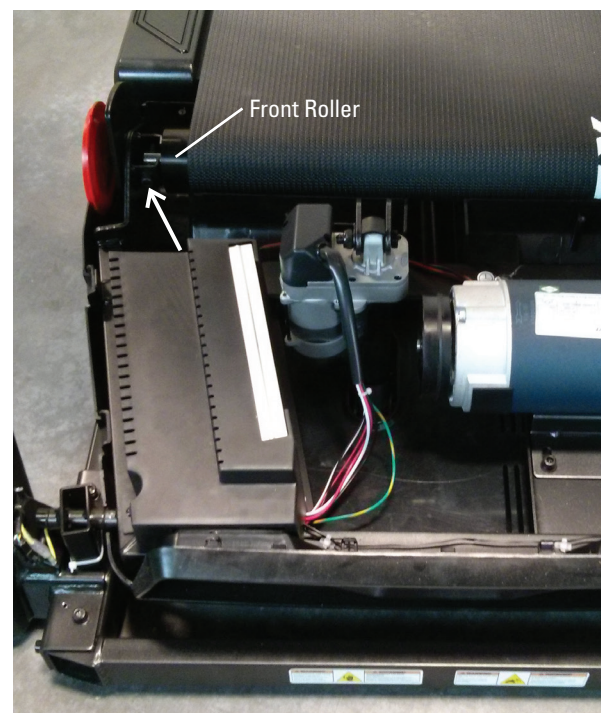



10. From the right side of the machine, grasp onto the Drive Pulley and pull it along with the Front Roller toward you. The Front Roller will “pop” out of the channel.

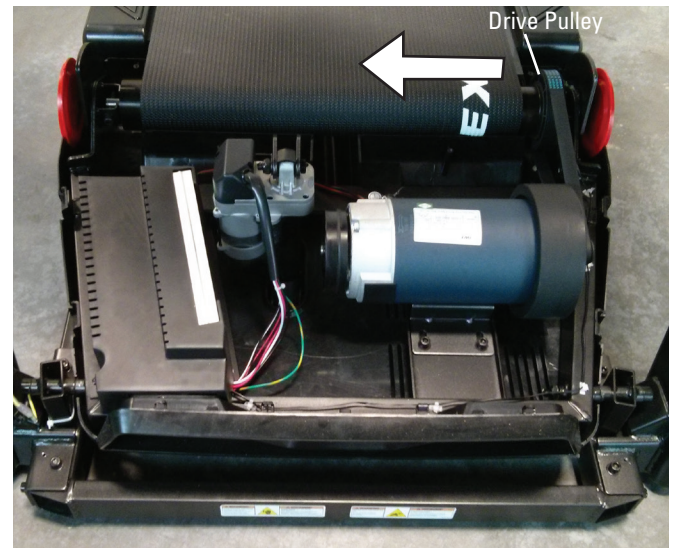



11. Lift and pivot the Front Roller out of the Frame. This will free the Drive Belt from the Front Roller.

12. Replace the old Drive Belt with the new Drive Belt around the Front Roller.

13. Insert the end of the Front Roller with the Drive Pulley into the Frame, and pivot the other end into the Bracket.

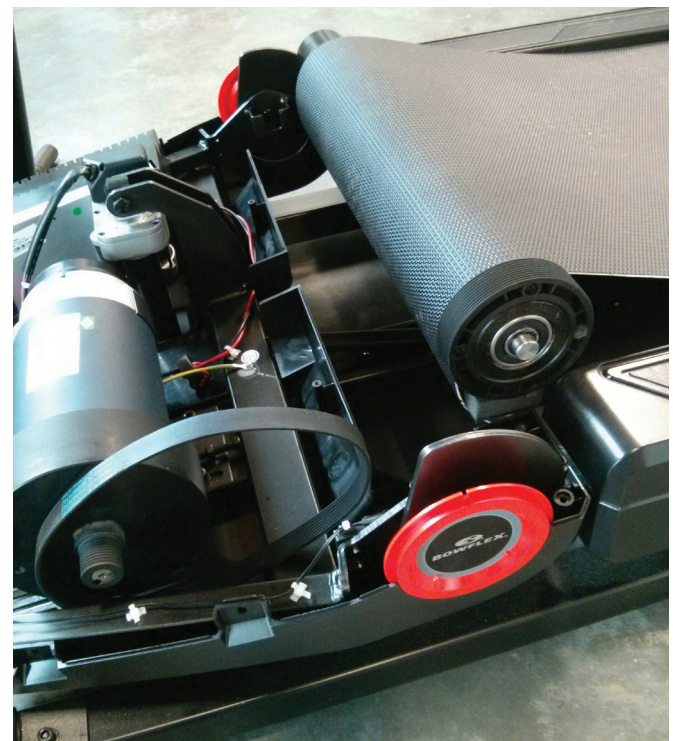
14. Loop the new Drive Belt around the Motor Pulley. Start the Drive Belt on the Drive Pulley and roll it in a clockwise motion. Be sure the Belt does not come off of the Motor Pulley.



 **Keep fingers out of any pinch opportunities when turning the Pulleys.**

15. Roll the Drive Pulley clockwise until the Drive Belt is fully installed. Continue to roll the Belt forward while adding side pressure with fingers to align as necessary.

16. With the Motor Assembly loosely attached to the Frame, turn the Belt Tensioner Screw to the previous level. This will tighten the Drive Belt to the previous tension level.

17. Using a 6mm hex wrench, fully tighten the screws that attach the Motor Mount to the Frame.

18. Re-install all remaining parts that were removed in reverse order.

19. Attach the power cord and turn on the Treadmill by flipping the power switch to ON.

20. From the Power Up (or Welcome) screen, push and hold down the PAUSE/STOP button and Right arrow button for about 5 seconds to go into the Console Setup Mode. The Console display will show the Date prompt with the current setting.

21. Push the OK button 4 times until the Console displays the TOTAL RUN HOURS screen.

22. Push and hold down the PAUSE/STOP button and Right arrow button for about 5 seconds to go into the Engineering Mode. The Console display will show the current Firmware Version.

23. Push the Down arrow button 4 times until the Console displays "RUN MCB CAL".

 **Be sure the area around the Treadmill is clear of all bystanders, children and pets. Be sure there is nothing on or under the Walking Belt, or near the Treadmill.**

24. With the area clear, push the OK button. The calibration procedure will begin by automatically moving the Walking Belt and lifting the Deck through the full range of incline motion.

 **Be sure not to touch or allow anyone else to touch the machine while calibration is occurring.**

25. When calibration is complete, the Console will display "done" for a few seconds, and then return to the "RUN MCB CAL" option.

26. Flip the power switch to OFF. Calibration is now complete for the machine.

27. Final Inspection

Inspect your machine to ensure that all hardware is tight and components are properly assembled.

 **Do not use until the machine has been fully assembled and inspected for correct performance in accordance with the Owner's Manual.**

**NOTICE:** This document provides instructions for the replacement of the Front Roller on the Bowflex® BXT116 / BXT216 Treadmills.

**If you need assistance, please call Bowflex Customer Service at 1-800-605-3369.**

 **This icon means a potentially hazardous situation which, if not avoided, could result in death or serious injury. Read and understand all Warnings on this machine.**

Nautilus, Inc., www.NautilusInc.com - Customer Service: North America (800) 605-3369, csnl@nautilus.com | outside U.S. www.nautilusinternational.com | Printed in China | © 2017 Nautilus, Inc. | ® indicates trademarks registered in the United States. These marks may be registered in other nations or otherwise protected by common law. Bowflex and the B logo are trademarks owned by or licensed to Nautilus, Inc.

### Important Safety Instructions - Before servicing or using this equipment, obey the following warnings:

 **This icon means a potentially hazardous situation which, if not avoided, could result in death or serious injury. Read and understand all Warnings on this machine.**

**DANGER** **To reduce the risk of electrical shock or unsupervised usage of the equipment, always unplug the power cord from the wall outlet and wait 5 minutes before cleaning, maintaining or repairing this machine. Place the power cord in a secure location.**

- Read and understand the Part Replacement Procedure before working on the machine. Failure to obey the instructions and safety warnings could cause injury to the service technician or bystanders.
- Keep bystanders, children and pets away from the product being serviced at all times.
- Make sure that the repair is done in an appropriate work space away from foot traffic and exposure to bystanders.
- Disconnect all power and allow to sit for 5 minutes before you service this machine.
- Some components of the equipment can be heavy or awkward. Enlist the service of a second person when you do maintenance steps involving these components. Do not try to do heavy or awkward steps on your own.
- If replacement parts are necessary, use only genuine Nautilus replacement parts and hardware. Failure to use genuine replacement parts can cause a risk to users, keep the machine from operating correctly and will void the warranty.
- Be sure that all warning stickers and instructional placards applied to the product stay present and in good condition when doing maintenance or replacing components. If necessary request replacement warning stickers or placards from Nautilus customer service.
- Do not try to change the design or functionality of the machine being serviced as this can adversely effect user safety and will void the warranty.
- Do not use the machine until all shrouds, instructions, warning labels and correct functionality have been verified and tested for correct performance.

### Tools Required (not included)

#2 Phillips screwdriver

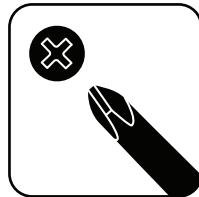

6mm Hex Wrench



13mm Wrench



**Note:** The Bowflex® BXT116 is used in the following images. The procedure is the same for the BXT216 model.

1. With power supplied to the machine and it turned on, adjust the Walking Deck Incline to a setting of '6'. To adjust, push the '6' Pre-Set Incline button, and then the Confirm Incline button. Allow the Walking Deck to adjust to the new incline height.

2. Unplug the power cord from the machine and wait 5 minutes. Place the power cord in a secure location.

**⚠ DANGER** To reduce the risk of electrical shock or unsupervised usage of the equipment, always unplug the power cord from the wall outlet and wait 5 minutes before cleaning, maintaining or repairing this machine. Place the power cord in a secure location.

3. Using a #2 Phillips screwdriver, remove the screw (indicated by ovals) from each of the Base Shrouds.

4. Remove the Base Shrouds from the machine.

5. Using a #2 Phillips screwdriver, remove the 10 indicated screws that secure the Motor Cover.

**Note:** There are 2 screws that secure the Motor Cover from the underside of the machine (see image to the right).

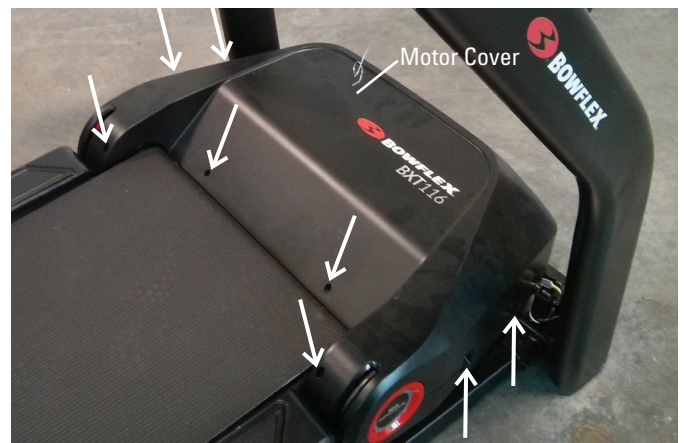

6. Gently release the front snaps (indicated by ovals) that secure the Motor Cover and pivot it back toward the walking belt until it releases. Remove from the machine.



7. Using a 6mm hex wrench, loosen the indicated screws (by arrow) on the Motor Mount.

8. Using a 13mm Open Ended Wrench, rotate the Belt Tensioner Screw enough to loosen the Drive Belt.  
**Note:** To assist with reassembly, be sure to record the number of threads exposed before loosening.

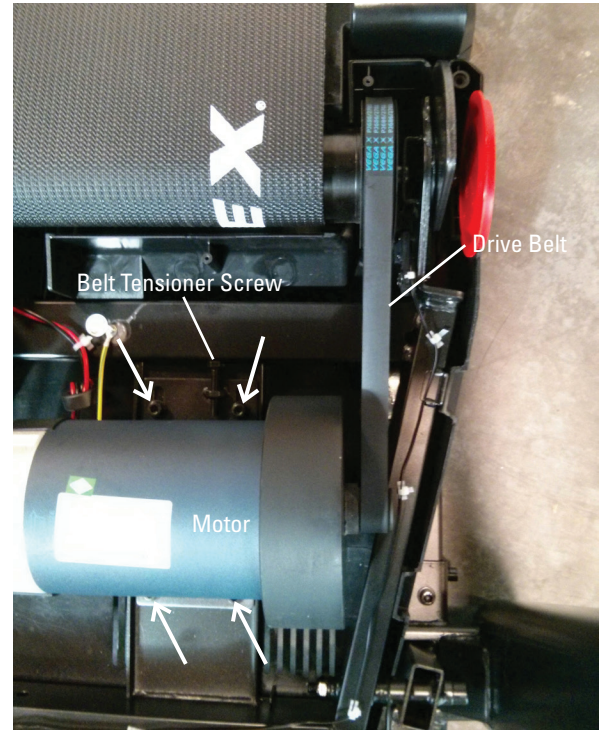

9. Using a 6mm hex wrench, remove the indicated screw from the Front Roller.

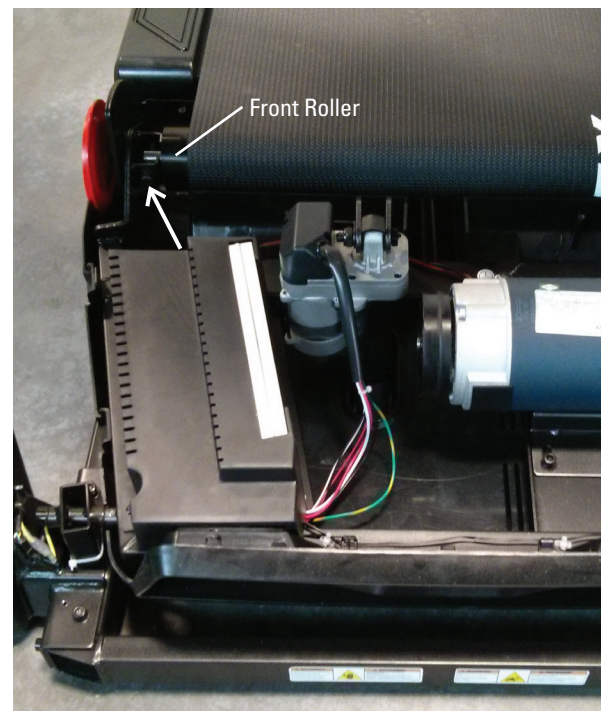

10. From the right side of the machine, grasp onto the Drive Pulley and pull it along with the Front Roller toward you. The Front Roller will “pop” out of the channel.

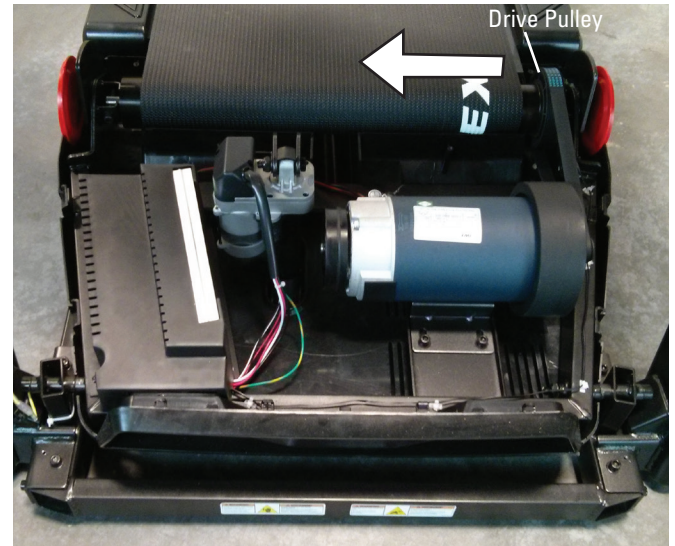

11. Slide the Front Roller out of the Walking Belt and replace with the new Front Roller in the same orientation.

12. Insert the end of the Front Roller with the Drive Pulley into the Frame, and pivot the other end into the Bracket.

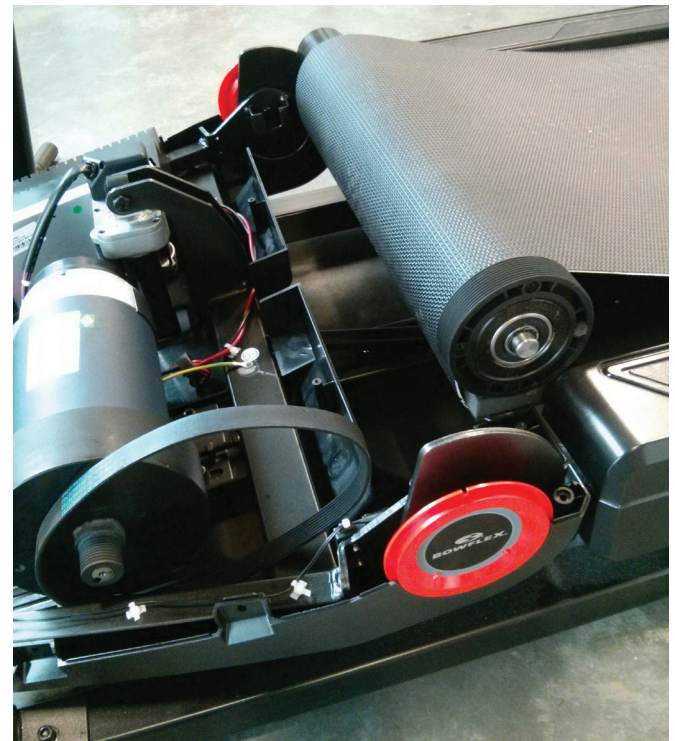

13. Using a 6mm hex wrench, attach the Front Roller to the Bracket.

**Note:** Tighten the hardware until the Front Roller is centered in the Bracket.

14. Loop the Drive Belt around the Motor Pulley. Start the Drive Belt on the Drive Pulley and roll it in a clockwise motion. Be sure the Belt does not come off of the Motor Pulley.



**Keep fingers out of any pinch opportunities when turning the Pulleys.**

15. Roll the Drive Pulley clockwise until the Drive Belt is fully installed. Continue to roll the Belt forward while adding side pressure with fingers to align as necessary.

16. With the Motor Assembly loosely attached to the Frame, turn the Belt Tensioner Screw to the previous level. This will tighten the Drive Belt to the previous tension level.

17. Using a 6mm hex wrench, fully tighten the screws that attach the Motor Mount to the Frame.

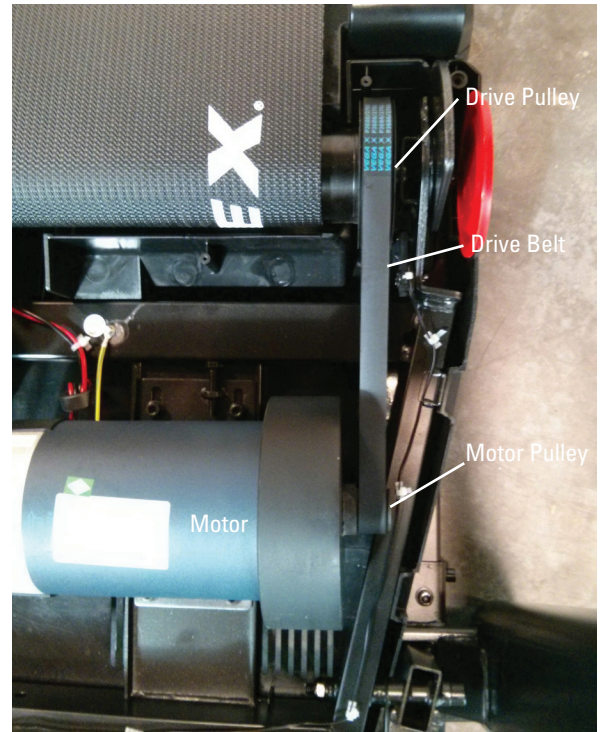

18. Re-install all remaining parts that were removed in reverse order.

19. Attach the power cord and turn on the Treadmill by flipping the power switch to ON.

20. From the Power Up (or Welcome) screen, push and hold down the PAUSE/STOP button and Right arrow button for about 5 seconds to go into the Console Setup Mode. The Console display will show the Date prompt with the current setting.

21. Push the OK button 4 times until the Console displays the TOTAL RUN HOURS screen.

22. Push and hold down the PAUSE/STOP button and Right arrow button for about 5 seconds to go into the Engineering Mode. The Console display will show the current Firmware Version.

23. Push the Down arrow button 4 times until the Console displays "RUN MCB CAL".



**Be sure the area around the Treadmill is clear of all bystanders, children and pets. Be sure there is nothing on or under the Walking Belt, or near the Treadmill.**

24. With the area clear, push the OK button. The calibration procedure will begin by automatically moving the Walking Belt and lifting the Deck through the full range of incline motion.



**Be sure not to touch or allow anyone else to touch the machine while calibration is occurring.**

25. When calibration is complete, the Console will display "done" for a few seconds, and then return to the "RUN MCB CAL" option.

26. Flip the power switch to OFF. Calibration is now complete for the machine.

27. Final Inspection

Inspect your machine to ensure that all hardware is tight and components are properly assembled.



**Do not use until the machine has been fully assembled and inspected for correct performance in accordance with the Owner's Manual.**



**NOTICE:** This document provides instructions for the replacement of the Incline Motor Assembly on the Bowflex® BXT116 / BXT216 Treadmills.

**If you need assistance, please call Bowflex Customer Service at 1-800-605-3369.**

 **This icon means a potentially hazardous situation which, if not avoided, could result in death or serious injury. Read and understand all Warnings on this machine.**

Nautilus, Inc., www.NautilusInc.com - Customer Service: North America (800) 605-3369, csnl@nautilus.com | outside U.S. www.nautilusinternational.com | Printed in China | © 2017 Nautilus, Inc. | ® indicates trademarks registered in the United States. These marks may be registered in other nations or otherwise protected by common law. Bowflex and the B logo are trademarks owned by or licensed to Nautilus, Inc.

### Important Safety Instructions - Before servicing or using this equipment, obey the following warnings:

 **This icon means a potentially hazardous situation which, if not avoided, could result in death or serious injury. Read and understand all Warnings on this machine.**

**DANGER** **To reduce the risk of electrical shock or unsupervised usage of the equipment, always unplug the power cord from the wall outlet and wait 5 minutes before cleaning, maintaining or repairing this machine. Place the power cord in a secure location.**

- Read and understand the Part Replacement Procedure before working on the machine. Failure to obey the instructions and safety warnings could cause injury to the service technician or bystanders.
- Keep bystanders, children and pets away from the product being serviced at all times.
- Make sure that the repair is done in an appropriate work space away from foot traffic and exposure to bystanders.
- Disconnect all power and allow to sit for 5 minutes before you service this machine.
- Some components of the equipment can be heavy or awkward. Enlist the service of a second person when you do maintenance steps involving these components. Do not try to do heavy or awkward steps on your own.
- If replacement parts are necessary, use only genuine Nautilus replacement parts and hardware. Failure to use genuine replacement parts can cause a risk to users, keep the machine from operating correctly and will void the warranty.
- Be sure that all warning stickers and instructional placards applied to the product stay present and in good condition when doing maintenance or replacing components. If necessary request replacement warning stickers or placards from Nautilus customer service.
- Do not try to change the design or functionality of the machine being serviced as this can adversely effect user safety and will void the warranty.
- Do not use the machine until all shrouds, instructions, warning labels and correct functionality have been verified and tested for correct performance.

### Tools Required (not included)

#2 Phillips screwdriver

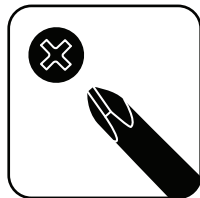

16mm wrench  
(2) 17mm wrenches

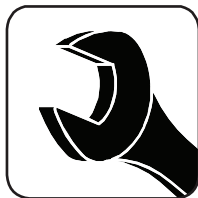

**Note:** The Bowflex® BXT116 is used in the following images. The procedure is the same for the BXT216 model.

1. With power supplied to the machine and it turned on, adjust the Walking Deck Incline to a setting of '6'. To adjust, push the '6' Pre-Set Incline button, and then the Confirm Incline button. Allow the Walking Deck to adjust to the new incline height.

2. Unplug the power cord from the machine and wait 5 minutes. Place the power cord in a secure location.

**⚠ DANGER** To reduce the risk of electrical shock or unsupervised usage of the equipment, always unplug the power cord from the wall outlet and wait 5 minutes before cleaning, maintaining or repairing this machine. Place the power cord in a secure location.

3. Using a #2 Phillips screwdriver, remove the screw (indicated by ovals) from each of the Base Shrouds.

4. Remove the Base Shrouds from the machine.

5. Using a #2 Phillips screwdriver, remove the 10 indicated screws that secure the Motor Cover.

**Note:** There are 2 screws that secure the Motor Cover from the underside of the machine (see image to the right).

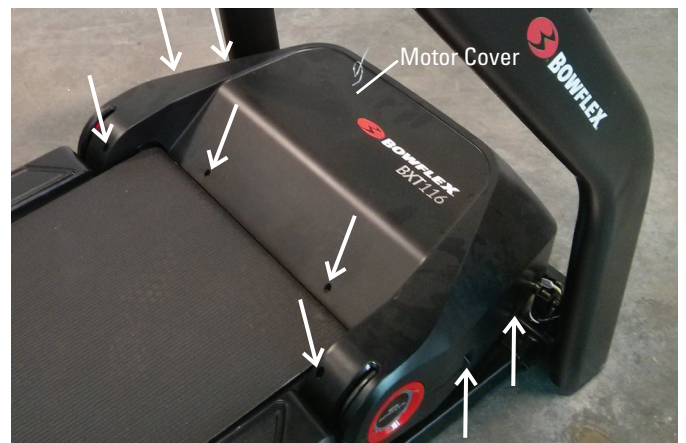

6. Gently release the front snaps (indicated by ovals) that secure the Motor Cover and pivot it back toward the walking belt until it releases. Remove from the machine.



7. Using a #2 Phillips screwdriver, remove the 2 indicated screws from the Motor Control Board Cover. Lift and remove the Motor Control Board Cover.

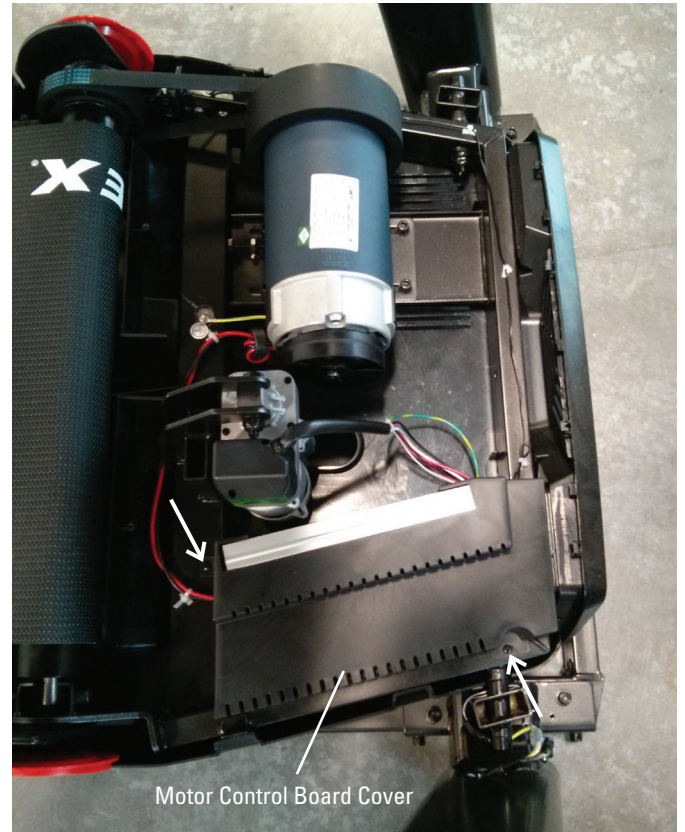

8. Remove the connectors for the Incline Motor Potentiometer and the Incline Motor from the Motor Control Board after noting their locations

**Note:** Be sure to note where all cables attach for re-assembly.

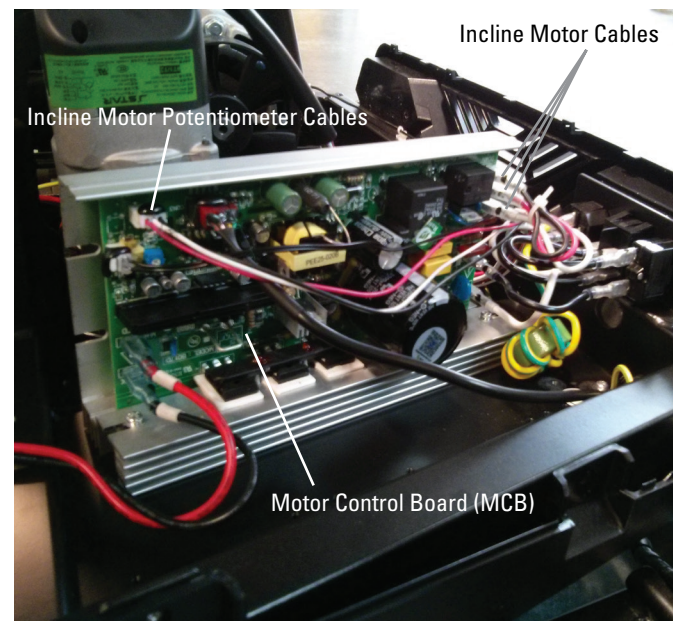

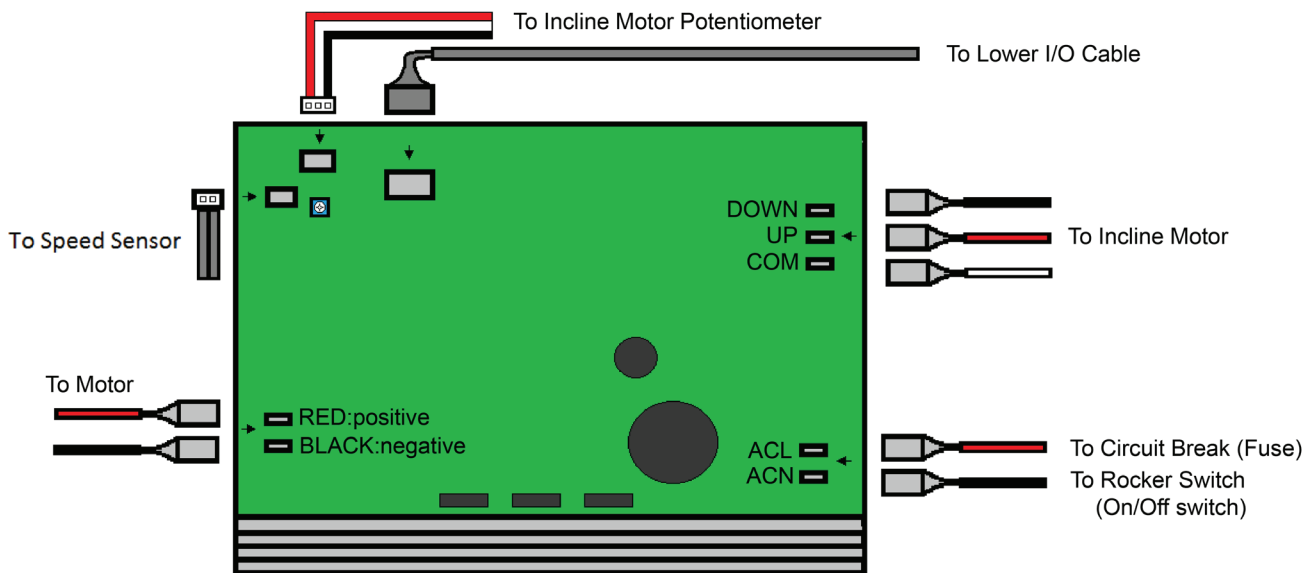
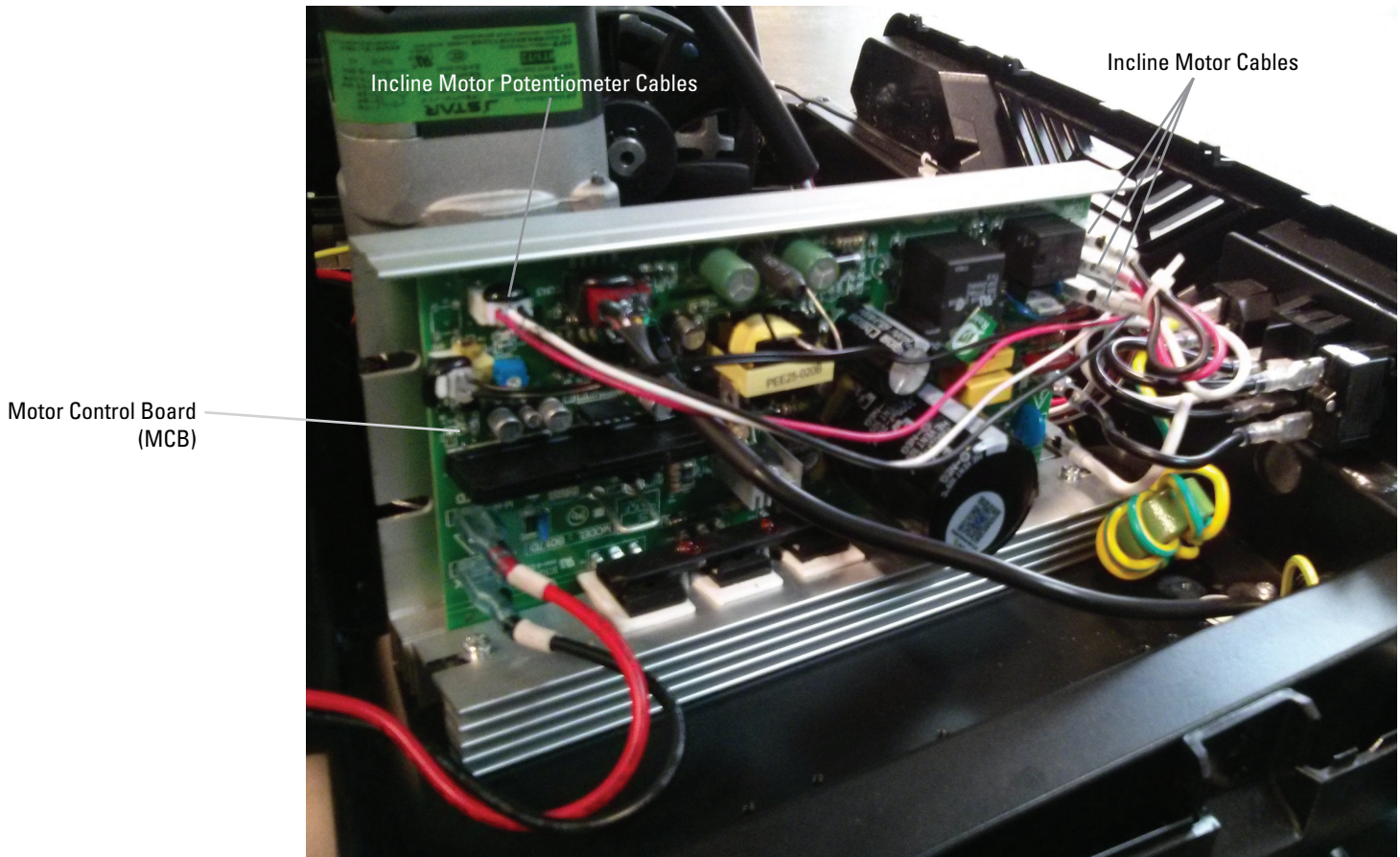

9. Using a 16mm and a 17mm wrench in the Motor Compartment, remove the hardware from the Incline Motor Assembly. Remove the Incline Motor Assembly noting how it extends from the Motor Compartment through to the Base Frame Weldment.

10. Make sure there is sufficient space to tilt the machine onto the left side.

**!** Keep a minimum clearance behind the machine of 79" (2 m) and 24" (0.6 m) on each side. This is the recommended safe distance for access, movement and emergency dismounts from the machine.

**Note:** THE FOLLOWING STEP MAY REQUIRE A SECOND PERSON.

11. Tilt the machine onto the left side.

**!** Be sure the area is clear around the machine before tilting it. Do not grasp the Walking Belt since it can abruptly move.

The machine may be moved by one or more persons depending on their physical abilities and capacities. Make sure that you and others are all physically fit and able to move the machine safely.

12. Using two 17mm wrenches, remove the indicated hardware (with arrow) from the Incline Motor Assembly.

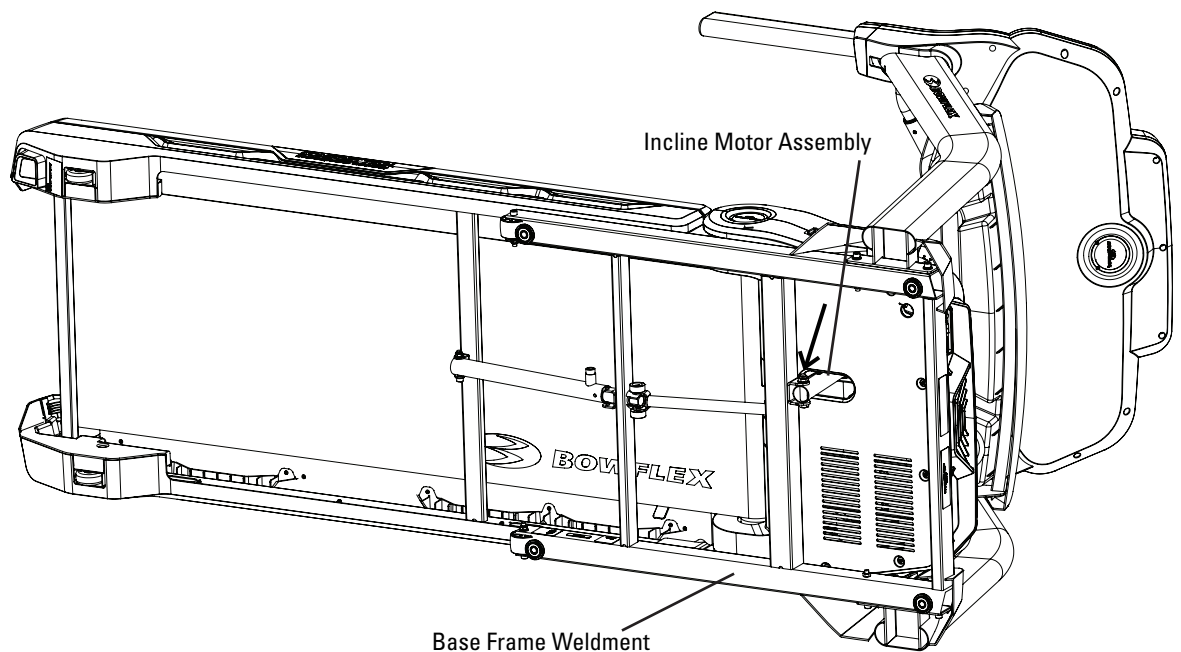
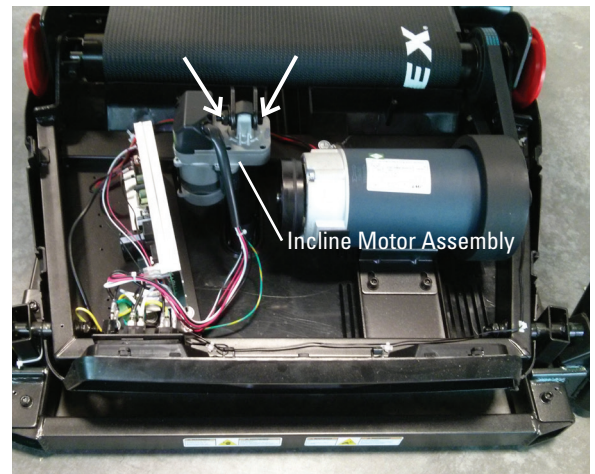

13. Installation of the Incline Motor Assembly is the reverse procedure.

**Note:** Be sure to attach the cables to the proper locations on the Motor Control Board. Do not crimp any cables.

14. Make sure there is sufficient space to tilt the machine back upright and that the area is clear.

 **This step requires two people. Be sure there is adequate clearance for the raised deck. Some components of the equipment can be heavy or awkward. Enlist the service of a second person when you do maintenance steps involving these components. Do not try to do heavy or awkward steps on your own.**

15. Re-install all remaining parts that were removed in reverse order.

16. Attach the power cord and turn on the Treadmill by flipping the power switch to ON.

17. From the Power Up (or Welcome) screen, push and hold down the PAUSE/STOP button and Down arrow button for about 5 seconds to go into the Machine Setting Mode. The Console display will show the TOTAL HOURS screen.

18. Push and hold down the PAUSE/STOP button and Down arrow button for about 5 seconds to go into the Engineering Mode.

19. Push the Down arrow button 14 times until the Console displays "ENTR MCB CLB".

 **Be sure the area around the Treadmill is clear of all bystanders, children and pets. Be sure there is nothing on or under the Walking Belt, or near the Treadmill.**

20. The Console will display "MCB CALIB".

21. With the area clear, push the ENTER button. The calibration procedure will begin by automatically moving the Walking Belt.

 **Be sure not to touch or allow anyone else to touch the machine while calibration is occurring.**

22. When calibration is complete, the Console will display "DONE".

23. Push the PAUSE/STOP button to exit the Engineering Mode.

24. Flip the power switch to OFF. Calibration is now complete for the machine.

25. Final Inspection

Inspect your machine to ensure that all hardware is tight and components are properly assembled.

 **Do not use until the machine has been fully assembled and inspected for correct performance in accordance with the Owner's Manual.**

**NOTICE:** This document provides instructions to replace the Lift Shock Assembly on the Bowflex® BXT116 Treadmill.

**If you need assistance, please call Bowflex Customer Service at 1-800-605-3369.**

 **This icon means a potentially hazardous situation which, if not avoided, could result in death or serious injury. Read and understand all Warnings on this machine.**

Nautilus, Inc., www.NautilusInc.com - Customer Service: North America (800) 605-3369, csnl@s@nautilus.com | outside U.S. www.nautilusinternational.com | Printed in China | © 2017 Nautilus, Inc. | ® indicates trademarks registered in the United States. These marks may be registered in other nations or otherwise protected by common law. Bowflex and the B logo are trademarks owned by or licensed to Nautilus, Inc.

### Important Safety Instructions - Before servicing or using this equipment, obey the following warnings:

 **This icon means a potentially hazardous situation which, if not avoided, could result in death or serious injury. Read and understand all Warnings on this machine.**

**⚠ DANGER** **To reduce the risk of electrical shock or unsupervised usage of the equipment, always unplug the power cord from the wall outlet and wait 5 minutes before cleaning, maintaining or repairing this machine. Place the power cord in a secure location.**

- Read and understand the Part Replacement Procedure before working on the machine. Failure to obey the instructions and safety warnings could cause injury to the service technician or bystanders.
- Keep bystanders, children and pets away from the product being serviced at all times.
- Make sure that the repair is done in an appropriate work space away from foot traffic and exposure to bystanders.
- Disconnect all power and allow to sit for 5 minutes before you service this machine.
- Some components of the equipment can be heavy or awkward. Enlist the service of a second person when you do maintenance steps involving these components. Do not try to do heavy or awkward steps on your own.
- If replacement parts are necessary, use only genuine Nautilus replacement parts and hardware. Failure to use genuine replacement parts can cause a risk to users, keep the machine from operating correctly and will void the warranty.
- Be sure that all warning stickers and instructional placards applied to the product stay present and in good condition when doing maintenance or replacing components. If necessary request replacement warning stickers or placards from Nautilus customer service.
- Do not try to change the design or functionality of the machine being serviced as this can adversely effect user safety and will void the warranty.
- Do not use the machine until all shrouds, instructions, warning labels and correct functionality have been verified and tested for correct performance.

### Tools Required (not included)

10mm wrench  
13mm wrench  
14mm wrench

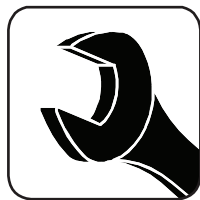

#2 Phillips screwdriver

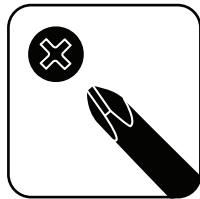

6mm hex wrench



**⚠ DANGER** To reduce the risk of electrical shock or unsupervised usage of the equipment, always unplug the power cord from the wall outlet and wait 5 minutes before cleaning, maintaining or repairing this machine. Place the power cord in a secure location.

1. Unplug the power cord from the machine and wait 5 minutes. Place the power cord in a secure location.

2. Make sure that there is safe clearance around, on and above the treadmill. Make sure there is no object to spill or cause blockage from the fully folded position.

**⚠** Be sure there is adequate height clearance for the raised deck.

3. Using the support bar found below the rear of the walking belt, push the Deck Release Handle and lift the walking deck fully upward and engage the hydraulic lift. Be sure that the hydraulic lift is correctly locked in place. You will hear an audible click when the hydraulic lift shifts into the locked position.

**⚠** Use proper safety precautions and lifting techniques. Bend your knees and elbows, keep your back straight and pull up equally with both arms. Straighten your legs to lift. Make sure that your own physical strength is capable of lifting the walking deck until it engages the locking mechanism. Use a second person if necessary.

Do not use the walking belt or rear roller to lift the treadmill. These parts do not lock in place and can abruptly move. Injury to you or damage to the machine can occur.

4. Make sure that the locking mechanism is engaged. Carefully pull back on the walking deck and make sure that it does not move. When you do this, keep clear of movement path in case the treadmill lock is not properly engaged.

**⚠** Do not lean against the treadmill when it is folded. Do not put items on it that could cause it to become unstable or fall.





5. Make sure that there is safe clearance around, above, and to one side of the treadmill. Tilt the machine onto the side being sure not to grasp the Console.

**!** A second person is required to assist with the tilting of the machine. Do not tilt the machine unless the walking deck is in the folded, locked position. Be sure there is adequate clearance for the raised deck. Some components of the equipment can be heavy or awkward. Enlist the service of a second person when you do maintenance steps involving these components. Do not try to do heavy or awkward steps on your own.



**DANGER** The following images show the machine upright, and not fully resting on its side. The machine must be on its side to safely complete the following steps.

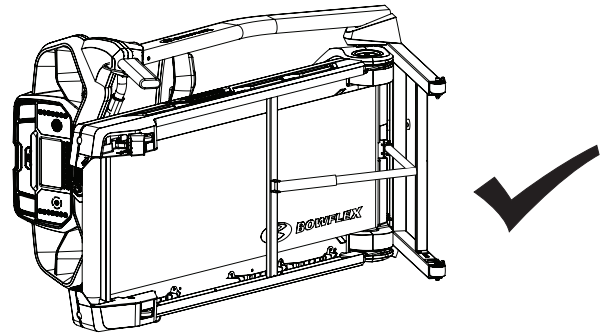

6. Using a 10mm wrench, loosen the locking nut for the Release Cable (indicated by arrow).

7. Using a 14mm wrench, disconnect the securing nut and remove the Release Cable Assembly from the Lift Shock.

8. Using a 13mm wrench and a 6mm hex wrench, remove the indicated hardware (with ovals) from the Lift Shock Assembly.

**!** Be aware that when the Lift Shock is released from the Frame Assembly, the Lift Shock and Base Frame Weldment may abruptly move. Be sure to keep clear of any potential pinch opportunities from this motion.

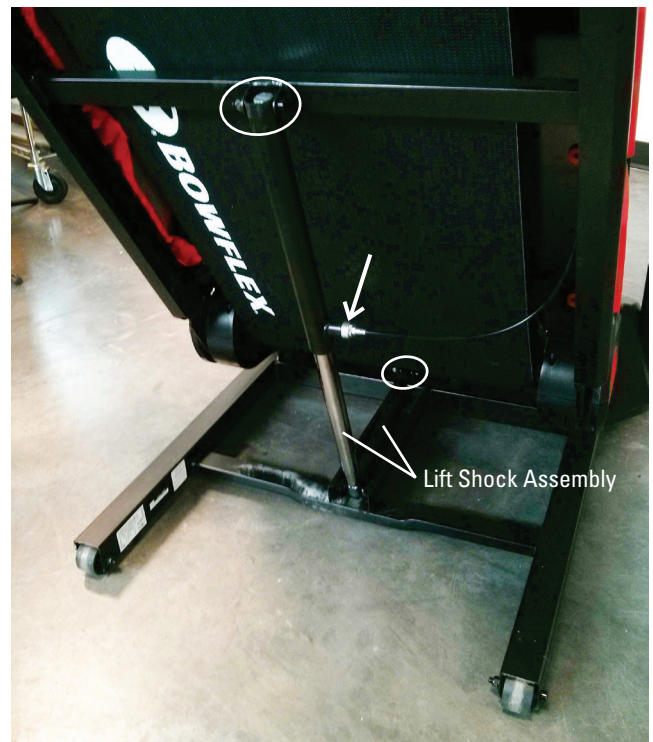

9. Remove the old Lift Shock and replace with the new Lift Shock.

10. Using a 10mm and a 14mm wrench, re-connect the cable to the Lift Cylinder.

11. Installation of the remaining parts is the reverse procedure.

12. Make sure there is sufficient space to tilt the machine back upright and that the area is clear.

 **This step requires two people. Be sure there is adequate clearance for the raised deck. Some components of the equipment can be heavy or awkward. Enlist the service of a second person when you do maintenance steps involving these components. Do not try to do heavy or awkward steps on your own.**

13. Make sure there is sufficient space to lower the walking deck.

 **Keep a minimum clearance behind the machine of 79" (2 m) and 24" (0.6 m) on each side. This is the recommended safe distance for access, movement and emergency dismounts from the machine.**

14. Make sure there is no object on or around the treadmill to spill or cause blockage from the fully unfolded position.

15. Slightly push the walking deck forward toward the console, and then push the Deck Release Handle until the locking tube releases and you can pull the walking deck away from the console. Hold up the rear of the walking deck, and move to the side of the machine.

 **Keep clear of the movement path of the walking deck.**

16. The hydraulic lift is set up to drop gradually. Hold onto the walking deck until approximately 2/3 of the movement down. Make sure that you use proper lifting technique; bend your knees and keep your back straight. Lower the weight with your legs. Be aware that the walking deck can possibly drop quickly in the last part of the movement.

17. Final Inspection

Inspect your machine to ensure that all hardware is tight and components are properly assembled.

 **Do not use until the machine has been fully assembled and inspected for correct performance in accordance with the Owner's Manual.**

**NOTICE:** This document provides instructions for the replacement of the Lower I/O Cable on the Bowflex® BXT116 Treadmill.

**If you need assistance, please call Bowflex Customer Service at 1-800-605-3369.**

**This icon means a potentially hazardous situation which, if not avoided, could result in death or serious injury. Read and understand all Warnings on this machine.**

Nautilus, Inc., www.NautilusInc.com - Customer Service: North America (800) 605-3369, csnl@nautilus.com | outside U.S. www.nautilusinternational.com | Printed in China | © 2017 Nautilus, Inc. | ® indicates trademarks registered in the United States. These marks may be registered in other nations or otherwise protected by common law. Bowflex and the B logo are trademarks owned by or licensed to Nautilus, Inc.

### Important Safety Instructions - Before servicing or using this equipment, obey the following warnings:

**This icon means a potentially hazardous situation which, if not avoided, could result in death or serious injury. Read and understand all Warnings on this machine.**

**⚠ DANGER** **To reduce the risk of electrical shock or unsupervised usage of the equipment, always unplug the power cord from the wall outlet and wait 5 minutes before cleaning, maintaining or repairing this machine. Place the power cord in a secure location.**

- Read and understand the Part Replacement Procedure before working on the machine. Failure to obey the instructions and safety warnings could cause injury to the service technician or bystanders.
- Keep bystanders, children and pets away from the product being serviced at all times.
- Make sure that the repair is done in an appropriate work space away from foot traffic and exposure to bystanders.
- Disconnect all power and allow to sit for 5 minutes before you service this machine.
- Some components of the equipment can be heavy or awkward. Enlist the service of a second person when you do maintenance steps involving these components. Do not try to do heavy or awkward steps on your own.
- If replacement parts are necessary, use only genuine Nautilus replacement parts and hardware. Failure to use genuine replacement parts can cause a risk to users, keep the machine from operating correctly and will void the warranty.
- Be sure that all warning stickers and instructional placards applied to the product stay present and in good condition when doing maintenance or replacing components. If necessary request replacement warning stickers or placards from Nautilus customer service.
- Do not try to change the design or functionality of the machine being serviced as this can adversely effect user safety and will void the warranty.
- Do not use the machine until all shrouds, instructions, warning labels and correct functionality have been verified and tested for correct performance.

### Tools Required (not included)

#2 Phillips screwdriver

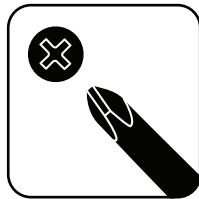

Standard screwdriver

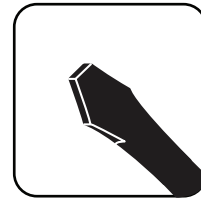

6mm hex wrench



1. With power supplied to the machine and it turned on, adjust the Walking Deck Incline to a setting of '6'. To adjust, push the '6' Pre-Set Incline button, and then the Confirm Incline button. Allow the Walking Deck to adjust to the new incline height.

2. Unplug the power cord from the machine and wait 5 minutes. Place the power cord in a secure location.

**⚠ DANGER** To reduce the risk of electrical shock or unsupervised usage of the equipment, always unplug the power cord from the wall outlet and wait 5 minutes before cleaning, maintaining or repairing this machine. Place the power cord in a secure location.

3. Using a #2 Phillips screwdriver, remove the screw (indicated by ovals) from each of the Base Shrouds.

4. Remove the Base Shrouds from the machine.



5. Using a #2 Phillips screwdriver, remove the 10 indicated screws that secure the Motor Cover.

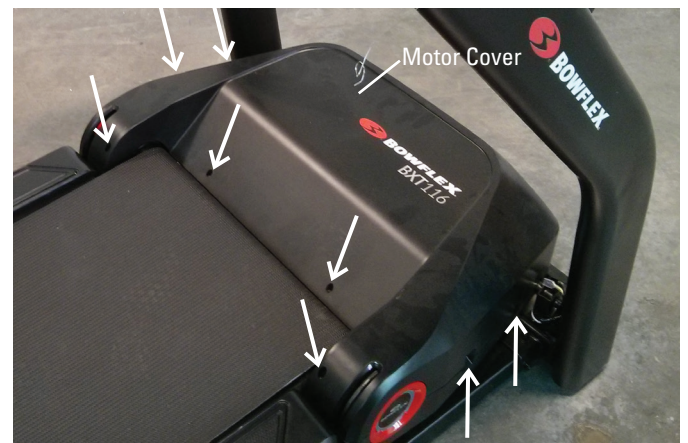

**Note:** There are 2 screws that secure the Motor Cover from the underside of the machine (see image to the right).



6. Gently release the front snaps (indicated by ovals) that secure the Motor Cover and pivot it back toward the walking belt until it releases. Remove from the machine.



7. Using a #2 Phillips screwdriver, remove the 2 indicated screws from the Motor Control Board Cover. Lift and remove the Motor Control Board Cover.

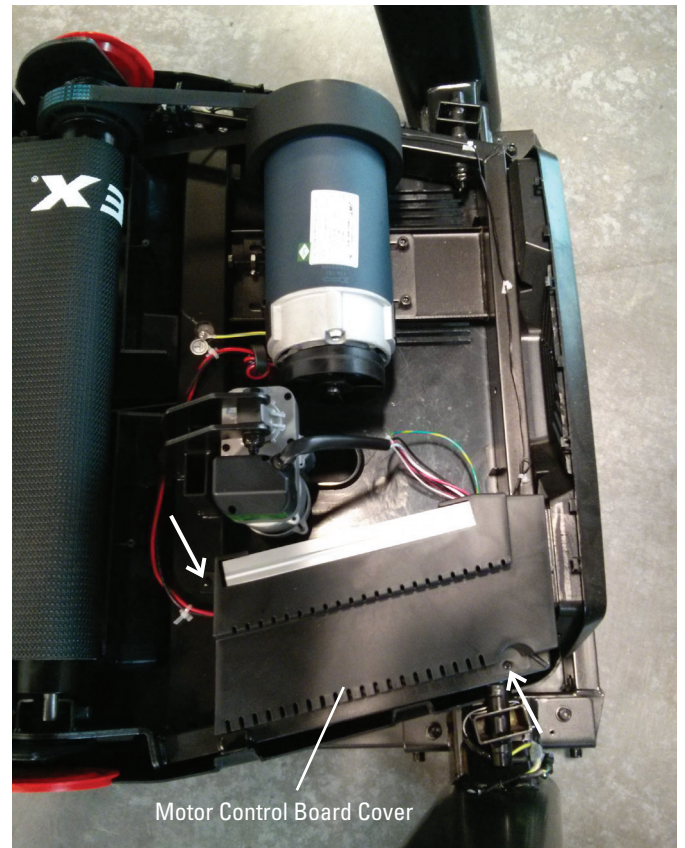

8. Remove the Lower I/O Cable connector from the Motor Control Board after noting the location.  
**Note:** Be sure to note where the Lower I/O Cable attaches for re-assembly.

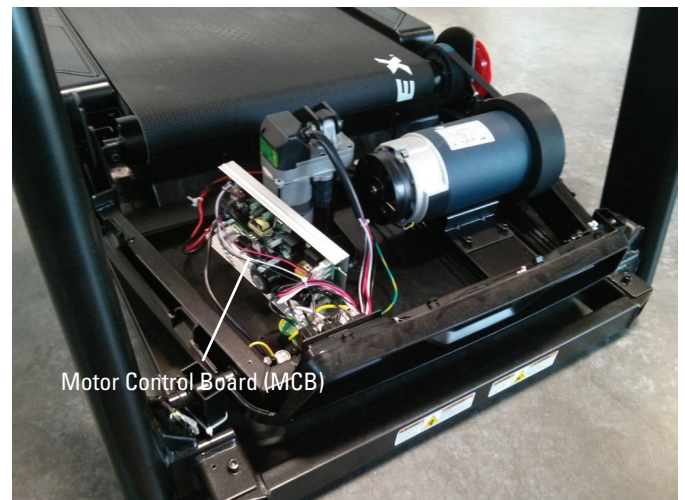

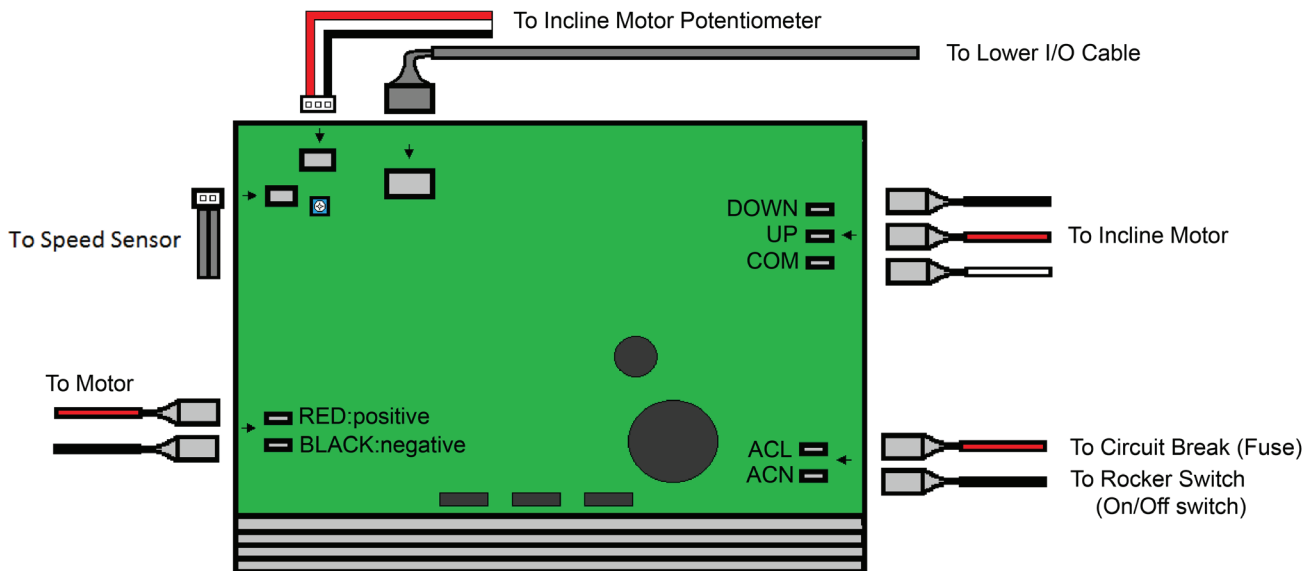
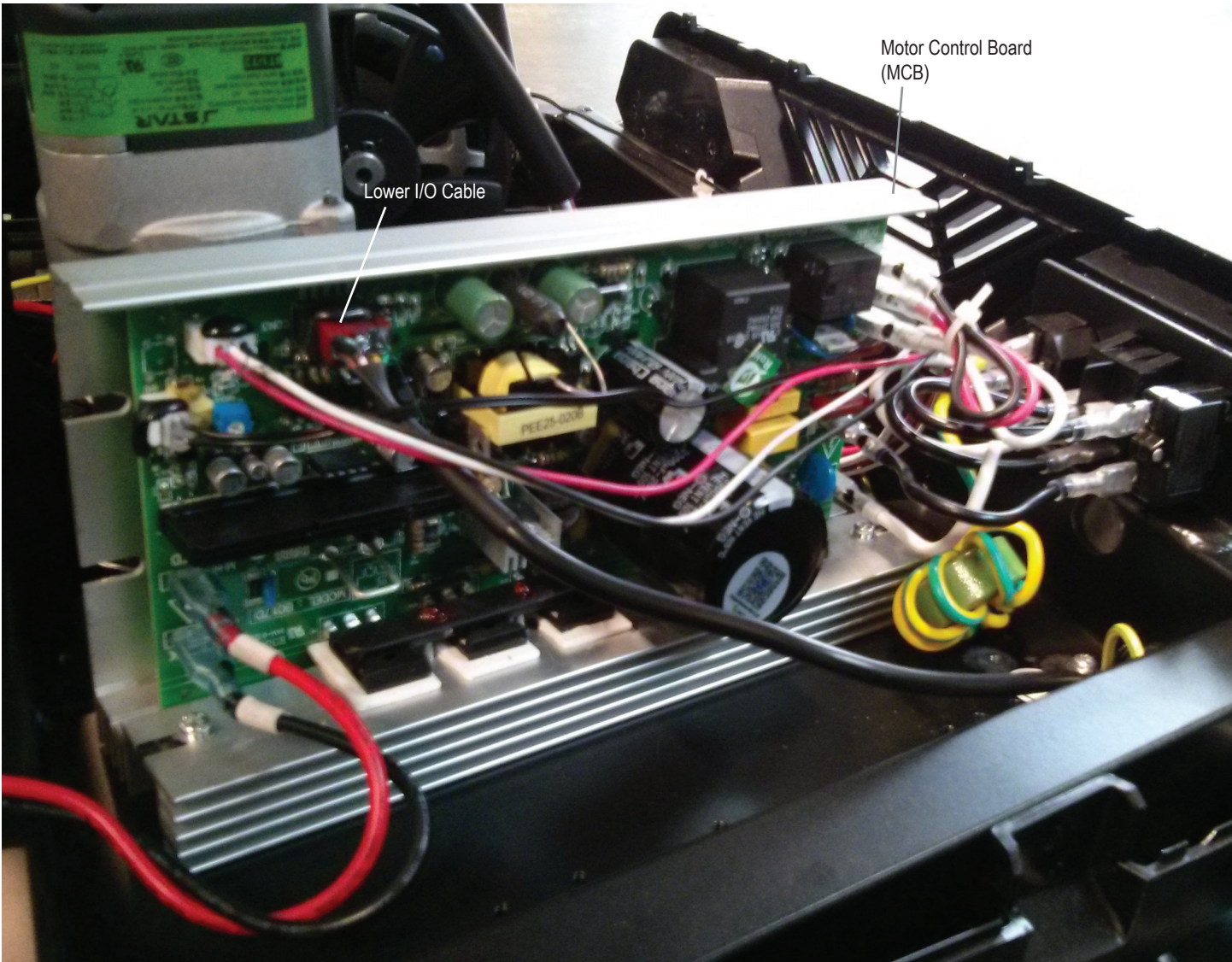

9. Using a standard screwdriver, gently lift and release the Junction Cover End Caps from the Console Assembly.



10. Using a #2 Phillips screwdriver, remove the 4 indicated screws (by arrows) from Lower Junction Covers.

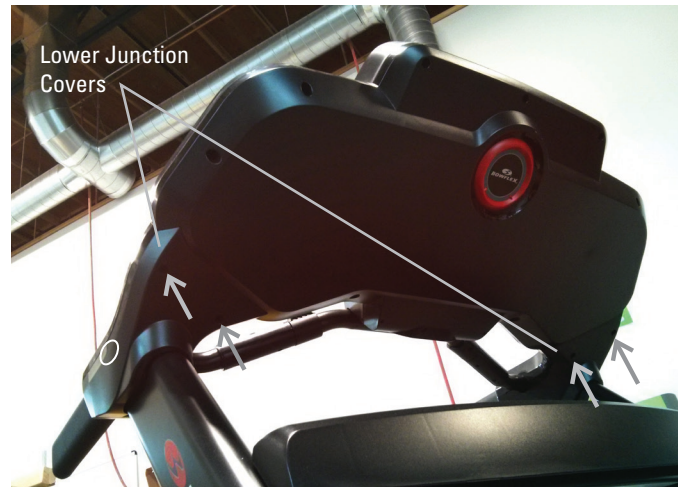

11. Gently release the snaps (indicated by ovals, two on each side) that secure the Upper and Lower Junction Covers and remove the Upper Junction Covers.



12. Gently pull out the Input/Output (I/O) and Grounding Cables from the Right Upright, and disconnect them. Do not allow the Cables to fall into the Right Upright. Secure them with A Zip-Tie, rubber band or piece of wire.

**Note:** Do not crimp the Cables.



13. Using a 6mm hex wrench, remove the 8 screws that secure the Console Assembly from the Right and Left Uprights.

**Note:** To assist with re-assembly, be sure to note that the curved washers are used facing the rear of the machine.

14. Fully remove the Console and Handlebar Assembly from the Uprights.



15. Remove the Lower Junction Covers from the Uprights.

16. Remove the Crossbar Tray from the Crossbar.

17. Remove the Right Base Shroud from the Base Assembly.



18. Using a 6mm hex wrench, remove the 4 screws from the Crossbar. Be prepared to support the Crossbar when the hardware is removed.





19. Using a 6mm hex wrench, remove the hardware from the Right Upright. Slightly remove the Right Upright from the Base Assembly exposing the Input/Output (I/O) and Grounding Cables. Disconnect the Cables and remove the Right Upright.

**Note:** Do not crimp cables.

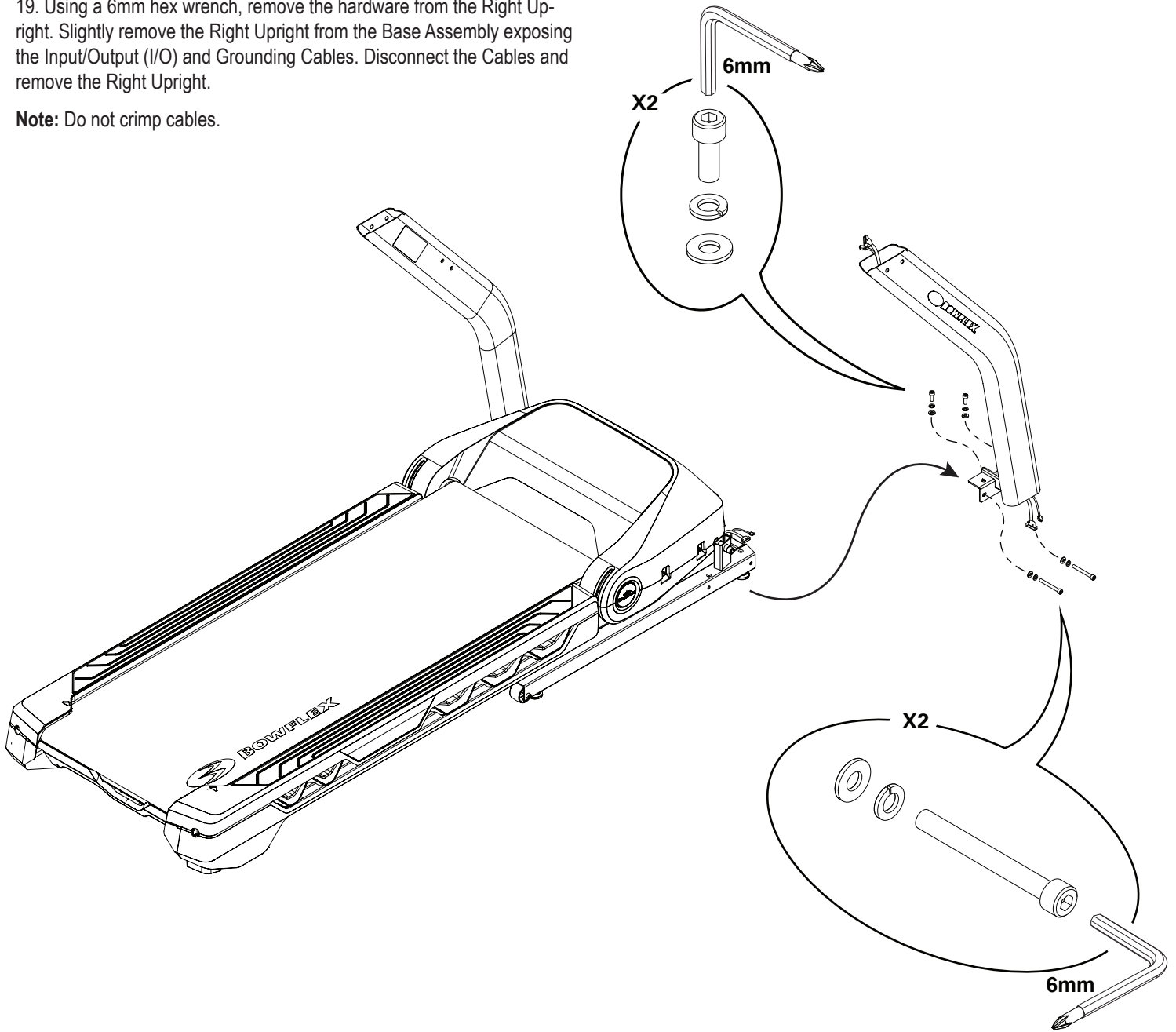

20. Remove the old Lower I/O Cable from the Frame Assembly. Route the new Lower I/O Cable into the Frame Assembly following the old Cable as a guide.

**Note:** Do not crimp the Cables.

21. Connect the Lower I/O Cable connector to the Motor Control Board in the proper location.

**Note:** Do not crimp the Cable.

22. Connect the Input/Output (I/O) Cables and attach the Right Upright to Frame Assembly

**Note:** This step may take two people to safely hold the Right Upright while the Cables are connected. Do not crimp the Cables. Do not fully tighten the Hardware until the Console and Handlebar Assembly has been attached.

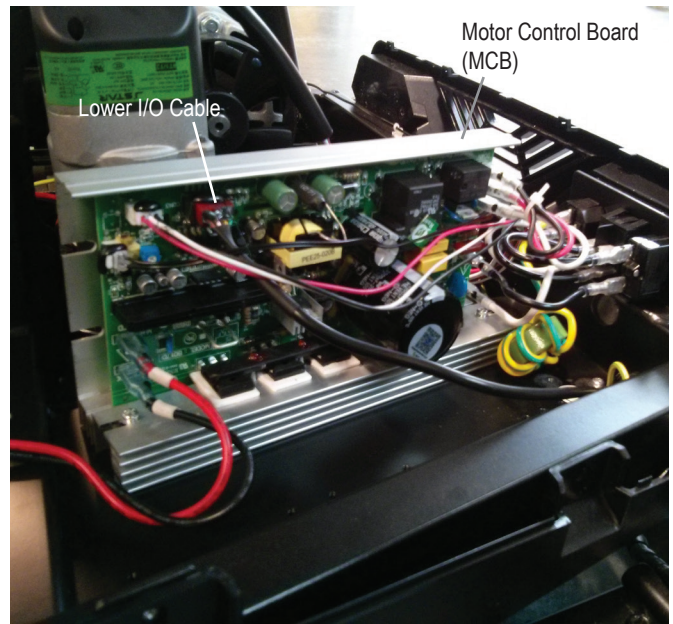

23. Re-install all remaining parts that were removed in reverse order.

24. Attach the power cord and turn on the Treadmill by flipping the power switch to ON.

25. From the Power Up (or Welcome) screen, push and hold down the PAUSE/STOP button and Down arrow button for about 5 seconds to go into the Machine Setting Mode. The Console display will show the TOTAL HOURS screen.

26. Push and hold down the PAUSE/STOP button and Down arrow button for about 5 seconds to go into the Engineering Mode.

27. Push the Down arrow button 14 times until the Console displays “ENTR MCB CLB”.

**⚠ Be sure the area around the Treadmill is clear of all bystanders, children and pets. Be sure there is nothing on or under the Walking Belt, or near the Treadmill.**

28. The Console will display “MCB CALIB”.

29. With the area clear, push the ENTER button. The calibration procedure will begin by automatically moving the Walking Belt.

**⚠ Be sure not to touch or allow anyone else to touch the machine while calibration is occurring.**

30. When calibration is complete, the Console will display “DONE”.

31. Push the PAUSE/STOP button to exit the Engineering Mode.

32. Flip the power switch to OFF. Calibration is now complete for the machine.

33. Final Inspection

Inspect your machine to ensure that all hardware is tight and components are properly assembled.

**⚠ Do not use until the machine has been fully assembled and inspected for correct performance in accordance with the Owner’s Manual.**

**NOTICE:** This document provides instructions to replace the Lower Side Rail on the Bowflex® BXT116 Treadmill.

**If you need assistance, please call Bowflex Customer Service at 1-800-605-3369.**

 **This icon means a potentially hazardous situation which, if not avoided, could result in death or serious injury. Read and understand all Warnings on this machine.**

Nautilus, Inc., (800) NAUTILUS / (800) 628-8458, www.NautilusInc.com - Customer Service: North America (800) 605-3369, csnl@nautilus.com | outside U.S. www.nautilusinternational.com | Printed in China | © 2017 Nautilus, Inc. | ® indicates trademarks registered in the United States. These marks may be registered in other nations or otherwise protected by common law. Bowflex and the B logo are trademarks owned by or licensed to Nautilus, Inc.

### Important Safety Instructions - Before servicing or using this equipment, obey the following warnings:

 **This icon means a potentially hazardous situation which, if not avoided, could result in death or serious injury. Read and understand all Warnings on this machine.**

**⚠ DANGER** To reduce the risk of electrical shock or unsupervised usage of the equipment, always unplug the power cord from the wall outlet and wait 5 minutes before cleaning, maintaining or repairing this machine. Place the power cord in a secure location.

- Read and understand the Part Replacement Procedure before working on the machine. Failure to obey the instructions and safety warnings could cause injury to the service technician or bystanders.
- Keep bystanders, children and pets away from the product being serviced at all times.
- Make sure that the repair is done in an appropriate work space away from foot traffic and exposure to bystanders.
- Disconnect all power and allow to sit for 5 minutes before you service this machine.
- Some components of the equipment can be heavy or awkward. Enlist the service of a second person when you do maintenance steps involving these components. Do not try to do heavy or awkward steps on your own.
- If replacement parts are necessary, use only genuine Nautilus replacement parts and hardware. Failure to use genuine replacement parts can cause a risk to users, keep the machine from operating correctly and will void the warranty.
- Be sure that all warning stickers and instructional placards applied to the product stay present and in good condition when doing maintenance or replacing components. If necessary request replacement warning stickers or placards from Nautilus customer service.
- Do not try to change the design or functionality of the machine being serviced as this can adversely effect user safety and will void the warranty.
- Do not use the machine until all shrouds, instructions, warning labels and correct functionality have been verified and tested for correct performance.

### Tools Required (not included)

#2 Phillips screwdriver

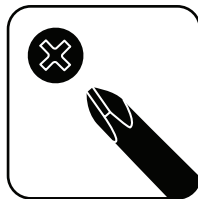

**⚠ DANGER** To reduce the risk of electrical shock or unsupervised usage of the equipment, always unplug the power cord from the wall outlet and wait 5 minutes before cleaning, maintaining or repairing this machine. Place the power cord in a secure location.

1. Unplug the power cord from the machine and wait 5 minutes. Place the power cord in a secure location.

2. Make sure that there is safe clearance around, on and above the treadmill. Make sure there is no object to spill or cause blockage from the fully folded position.

**⚠** Be sure there is adequate height clearance for the raised deck.

3. Using the support bar found below the rear of the walking belt, push the Deck Release Handle and lift the walking deck fully upward and engage the hydraulic lift. Be sure that the hydraulic lift is correctly locked in place. You will hear an audible click when the hydraulic lift shifts into the locked position.

**⚠** Use proper safety precautions and lifting techniques. Bend your knees and elbows, keep your back straight and pull up equally with both arms. Straighten your legs to lift. Make sure that your own physical strength is capable of lifting the walking deck until it engages the locking mechanism. Use a second person if necessary.

Do not use the walking belt or rear roller to lift the treadmill. These parts do not lock in place and can abruptly move. Injury to you or damage to the machine can occur.

4. Make sure that the locking mechanism is engaged. Carefully pull back on the walking deck and make sure that it does not move. When you do this, keep clear of movement path in case the treadmill lock is not properly engaged.

**⚠** Do not lean against the treadmill when it is folded. Do not put items on it that could cause it to become unstable or fall.

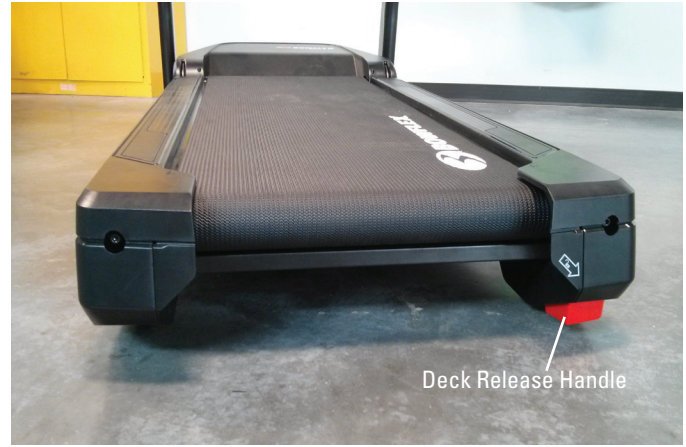

5. Using a #2 Phillips screwdriver, remove the two indicated screws from the Rear Roller Cover.

6. Remove the Rear Roller Cover noting how it attaches for re-assembly.



7. Using a #2 Phillips screwdriver, remove the 4 indicated screws from the Lower Side Rail.

8. Remove the Lower Side Rail noting how it attaches for re-assembly.



9. Re-install all parts that were removed in reverse order.

10. Make sure there is sufficient space to lower the walking deck.

 **Keep a minimum clearance behind the machine of 79" (2 m) and 24" (0.6 m) on each side. This is the recommended safe distance for access, movement and emergency dismounts from the machine.**

11. Make sure there is no object on or around the treadmill to spill or cause blockage from the fully unfolded position.

12. Slightly push the walking deck forward toward the console, and then push the Deck Release Handle until the locking tube releases and you can pull the walking deck away from the console. Hold up the rear of the walking deck, and move to the side of the machine.

 **Keep clear of the movement path of the walking deck.**

13. The hydraulic lift is set up to drop gradually. Hold onto the walking deck until approximately 2/3 of the movement down. Make sure that you use proper lifting technique; bend your knees and keep your back straight. Lower the weight with your legs. Be aware that the walking deck can possibly drop quickly in the last part of the movement.

14. Final Inspection

Inspect your machine to ensure that all hardware is tight and components are properly assembled.

 **Do not use until the machine has been fully assembled and inspected for correct performance in accordance with the Owner's Manual.**

**NOTICE:** This document provides instructions for the replacement of the Middle I/O Cable on the Bowflex® BXT116 Treadmill.

**If you need assistance, please call Bowflex Customer Service at 1-800-605-3369.**

 **This icon means a potentially hazardous situation which, if not avoided, could result in death or serious injury. Read and understand all Warnings on this machine.**

Nautilus, Inc., (800) NAUTILUS / (800) 628-8458, www.NautilusInc.com - Customer Service: North America (800) 605-3369, csnl@nautilus.com | outside U.S. www.nautilusinternational.com | Printed in China | © 2017 Nautilus, Inc. | ® indicates trademarks registered in the United States. These marks may be registered in other nations or otherwise protected by common law. Bowflex and the B logo are trademarks owned by or licensed to Nautilus, Inc.

### Important Safety Instructions - Before servicing or using this equipment, obey the following warnings:

 **This icon means a potentially hazardous situation which, if not avoided, could result in death or serious injury. Read and understand all Warnings on this machine.**

**⚠ DANGER** To reduce the risk of electrical shock or unsupervised usage of the equipment, always unplug the power cord from the wall outlet and wait 5 minutes before cleaning, maintaining or repairing this machine. Place the power cord in a secure location.

- Read and understand the Part Replacement Procedure before working on the machine. Failure to obey the instructions and safety warnings could cause injury to the service technician or bystanders.
- Keep bystanders, children and pets away from the product being serviced at all times.
- Make sure that the repair is done in an appropriate work space away from foot traffic and exposure to bystanders.
- Disconnect all power and allow to sit for 5 minutes before you service this machine.
- Some components of the equipment can be heavy or awkward. Enlist the service of a second person when you do maintenance steps involving these components. Do not try to do heavy or awkward steps on your own.
- If replacement parts are necessary, use only genuine Nautilus replacement parts and hardware. Failure to use genuine replacement parts can cause a risk to users, keep the machine from operating correctly and will void the warranty.
- Be sure that all warning stickers and instructional placards applied to the product stay present and in good condition when doing maintenance or replacing components. If necessary request replacement warning stickers or placards from Nautilus customer service.
- Do not try to change the design or functionality of the machine being serviced as this can adversely effect user safety and will void the warranty.
- Do not use the machine until all shrouds, instructions, warning labels and correct functionality have been verified and tested for correct performance.

### Tools Required (not included)

#2 Phillips screwdriver

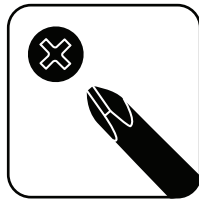

Standard screwdriver



6mm hex wrench



A short piece of wire or string



**⚠ DANGER**

To reduce the risk of electrical shock or unsupervised usage of the equipment, always unplug the power cord from the wall outlet and wait 5 minutes before cleaning, maintaining or repairing this machine. Place the power cord in a secure location.

1. Unplug the power cord from the machine and wait 5 minutes. Place the power cord in a secure location.

2. Using a standard screwdriver, gently lift and release the Junction Cover End Caps from the Console Assembly.

3. Remove the Junction Cover End Caps from the Console Assembly.



4. Using a #2 Phillips screwdriver, remove the 4 indicated screws (by arrows) from Lower Junction Covers.

5. Gently release the snaps (indicated by ovals, two on each side) that secure the Upper and Lower Junction Covers and remove the Upper Junction Covers.

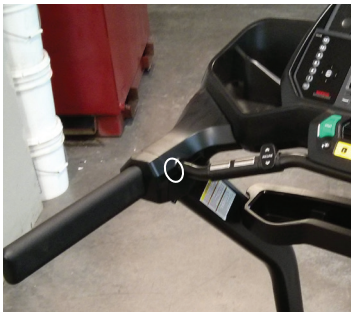
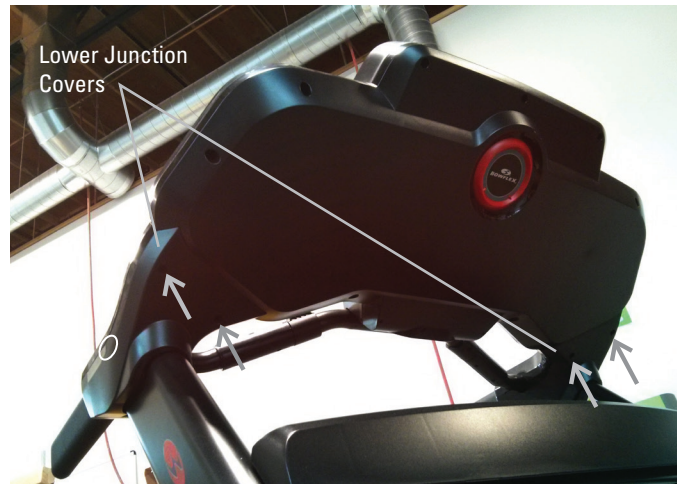

6. Gently pull out the Input/Output (I/O) and Grounding Cables from the Right Upright, and disconnect them. Do not allow the Cables to fall into the Right Upright. Secure them with A Zip-Tie, rubber band or piece of wire.

**Note:** Do not crimp the Cables.





7. Using a 6mm hex wrench, remove the 8 screws that secure the Console Assembly from the Right and Left Uprights.

**Note:** To assist with re-assembly, be sure to note that the curved washers are used facing the rear of the machine.

8. Fully remove the Console and Handlebar Assembly from the Uprights.



9. Remove the Lower Junction Covers from the Uprights.

10. Remove the Crossbar Tray from the Crossbar.

11. Remove the Right Base Shroud from the Base Assembly.



12. Using a 6mm hex wrench, remove the 4 screws from the Crossbar. Be prepared to support the Crossbar when the hardware is removed.



13. Using a 6mm hex wrench, remove the hardware from the Right Upright. Slightly remove the Right Upright from the Base Assembly exposing the Cables. Disconnect the Cables and remove the Right Upright.

**Note:** Do not crimp cables.

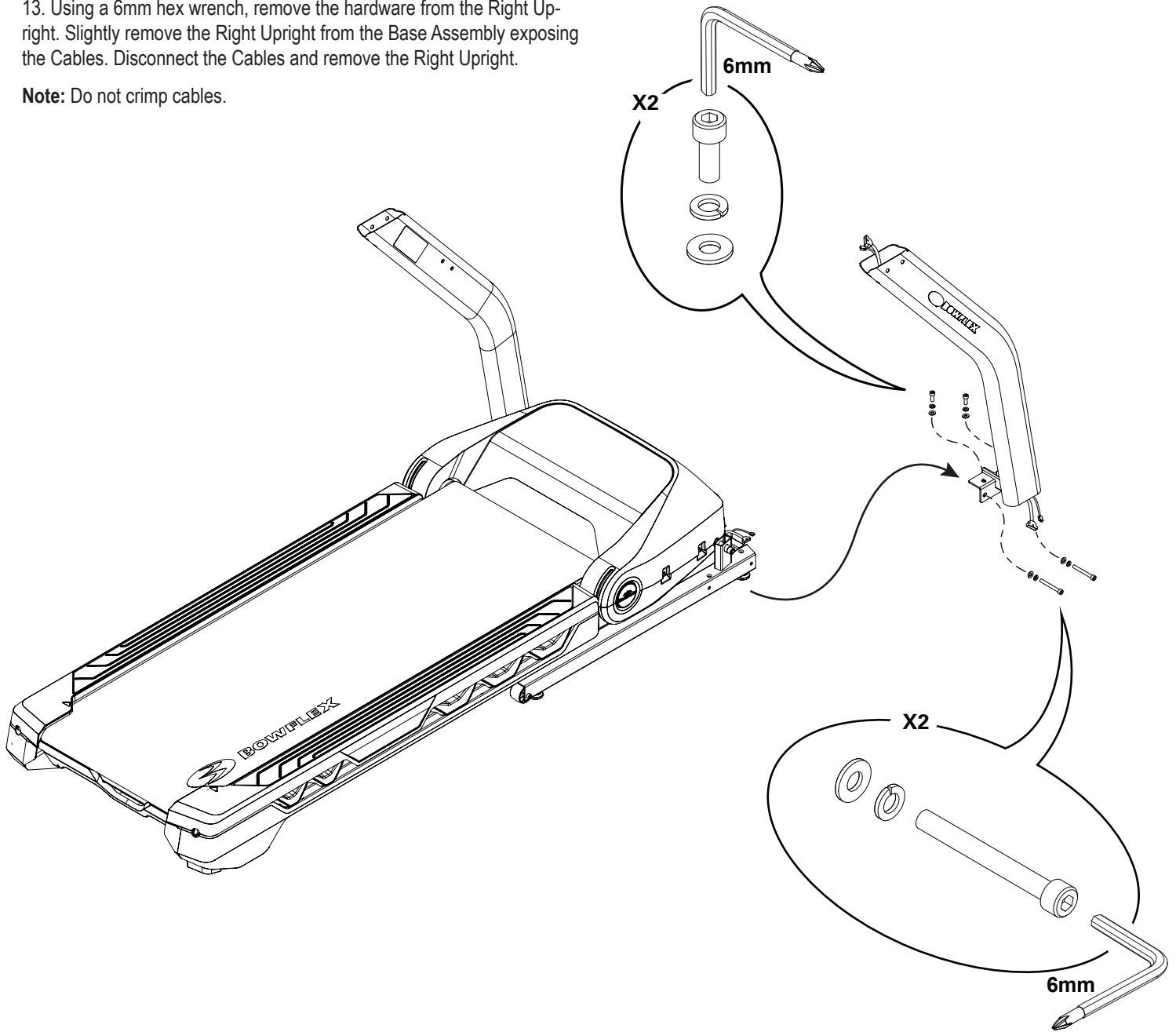

14. Using some cable or string, attach the upper connector of the new Middle I/O Cable to the lower connector of the old Middle I/O Cable.

15. Gently pull the old I/O Cable from the Right Upright. This will pull out the old I/O Cable and place the new I/O Cable.

**Note:** Be sure the cable does not crimp when being routed.

16. Connect the Cables and attach the new Right Upright to Frame Assembly

**Note:** This step may take two people to safely hold the Right Upright while the Cables are connected. Do not crimp the Cables. Do not fully tighten the Hardware until the Console and Handlebar Assembly has been attached.

17. Re-install all remaining parts that were removed in reverse order.

18. Final Inspection

Inspect your machine to ensure that all hardware is tight and components are properly assembled.

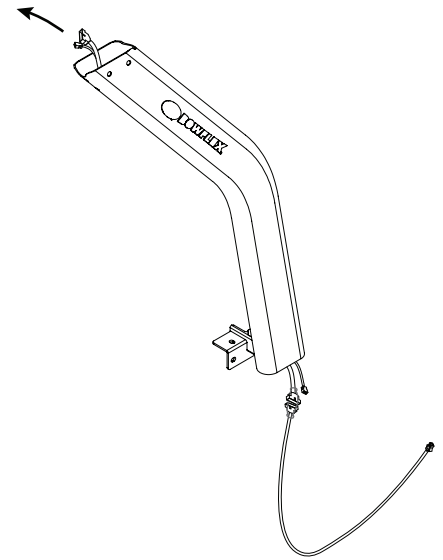

**Do not use until the machine has been fully assembled and inspected for correct performance in accordance with the Owner's Manual.**

**NOTICE:** This document provides instructions for the replacement of the Motor on the Bowflex® BXT116 / BXT216 Treadmills.

**If you need assistance, please call Bowflex Customer Service at 1-800-605-3369.**

**This icon means a potentially hazardous situation which, if not avoided, could result in death or serious injury. Read and understand all Warnings on this machine.**

Nautilus, Inc., www.NautilusInc.com - Customer Service: North America (800) 605-3369, csnl@nautilus.com | outside U.S. www.nautilusinternational.com | Printed in China | © 2017 Nautilus, Inc. | ® indicates trademarks registered in the United States. These marks may be registered in other nations or otherwise protected by common law. Bowflex and the B logo are trademarks owned by or licensed to Nautilus, Inc.

### Important Safety Instructions - Before servicing or using this equipment, obey the following warnings:

**This icon means a potentially hazardous situation which, if not avoided, could result in death or serious injury. Read and understand all Warnings on this machine.**

**DANGER** **To reduce the risk of electrical shock or unsupervised usage of the equipment, always unplug the power cord from the wall outlet and wait 5 minutes before cleaning, maintaining or repairing this machine. Place the power cord in a secure location.**

- Read and understand the Part Replacement Procedure before working on the machine. Failure to obey the instructions and safety warnings could cause injury to the service technician or bystanders.
- Keep bystanders, children and pets away from the product being serviced at all times.
- Make sure that the repair is done in an appropriate work space away from foot traffic and exposure to bystanders.
- Disconnect all power and allow to sit for 5 minutes before you service this machine.
- Some components of the equipment can be heavy or awkward. Enlist the service of a second person when you do maintenance steps involving these components. Do not try to do heavy or awkward steps on your own.
- If replacement parts are necessary, use only genuine Nautilus replacement parts and hardware. Failure to use genuine replacement parts can cause a risk to users, keep the machine from operating correctly and will void the warranty.
- Be sure that all warning stickers and instructional placards applied to the product stay present and in good condition when doing maintenance or replacing components. If necessary request replacement warning stickers or placards from Nautilus customer service.
- Do not try to change the design or functionality of the machine being serviced as this can adversely effect user safety and will void the warranty.
- Do not use the machine until all shrouds, instructions, warning labels and correct functionality have been verified and tested for correct performance.

### Tools Required (not included)

#2 Phillips screwdriver

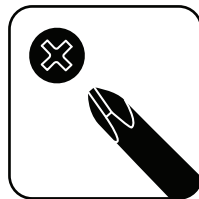

6mm Hex Wrench



13mm Wrench

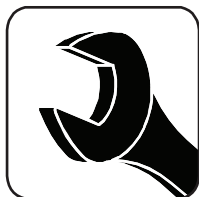

**Note:** The Bowflex® BXT116 is used in the following images. The procedure is the same for the BXT216 model.

1. With power supplied to the machine and it turned on, adjust the Walking Deck Incline to a setting of '6'. To adjust, push the '6' Pre-Set Incline button, and then the Confirm Incline button. Allow the Walking Deck to adjust to the new incline height.

2. Unplug the power cord from the machine and wait 5 minutes. Place the power cord in a secure location.

**⚠ DANGER** To reduce the risk of electrical shock or unsupervised usage of the equipment, always unplug the power cord from the wall outlet and wait 5 minutes before cleaning, maintaining or repairing this machine. Place the power cord in a secure location.

3. Using a #2 Phillips screwdriver, remove the screw (indicated by ovals) from each of the Base Shrouds.

4. Remove the Base Shrouds from the machine.

5. Using a #2 Phillips screwdriver, remove the 10 indicated screws that secure the Motor Cover.

**Note:** There are 2 screws that secure the Motor Cover from the underside of the machine (see image to the right).

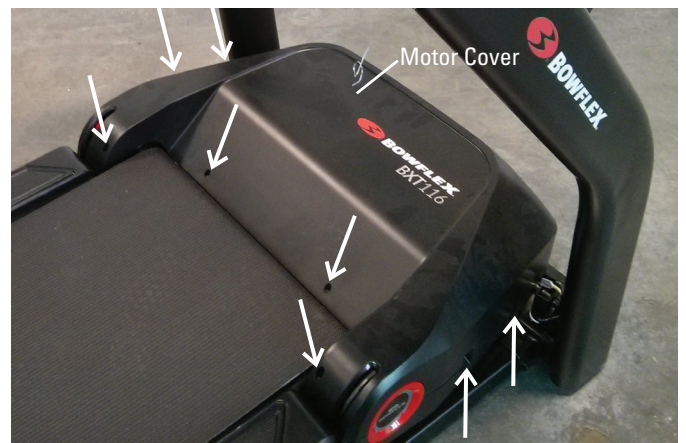

6. Gently release the front snaps (indicated by ovals) that secure the Motor Cover and pivot it back toward the walking belt until it releases. Remove from the machine.



7. Using a #2 Phillips screwdriver, remove the 2 indicated screws from the Motor Control Board Cover. Lift and remove the Motor Control Board Cover.

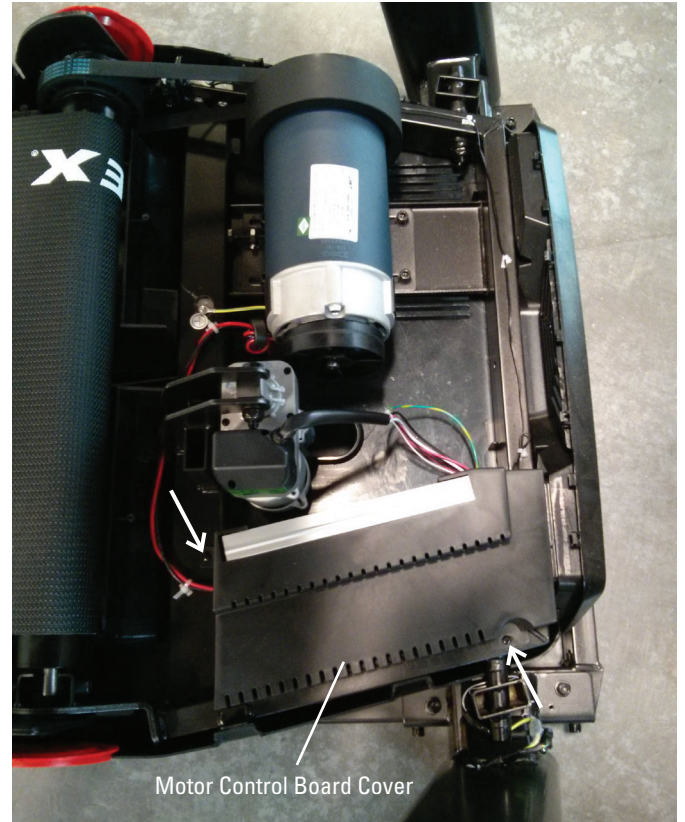

8. Remove the connectors for the Motor from the Motor Control Board after noting their locations.

**Note:** Be sure to note where all cables attach for re-assembly.

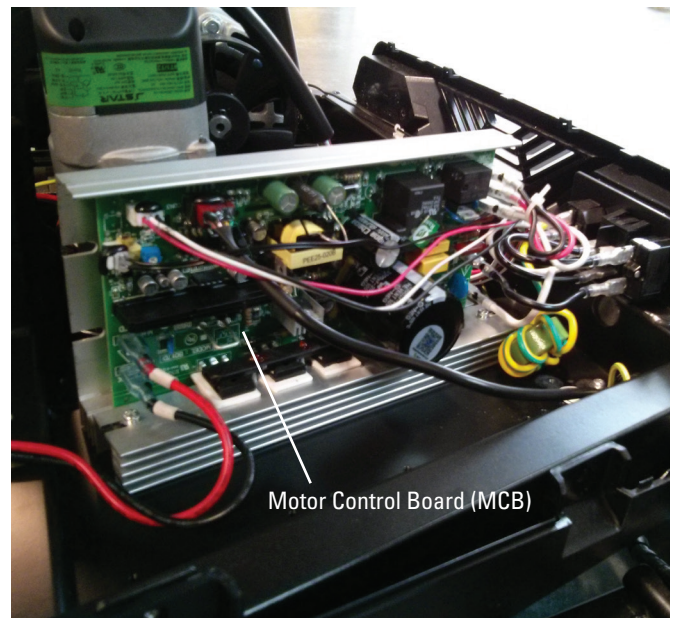

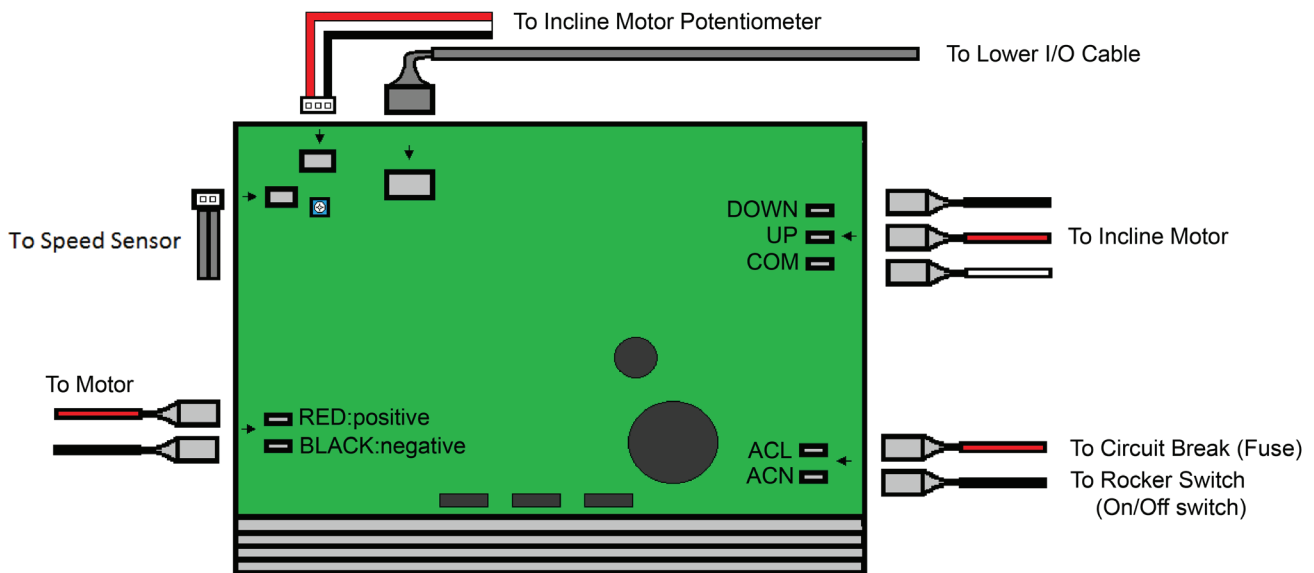
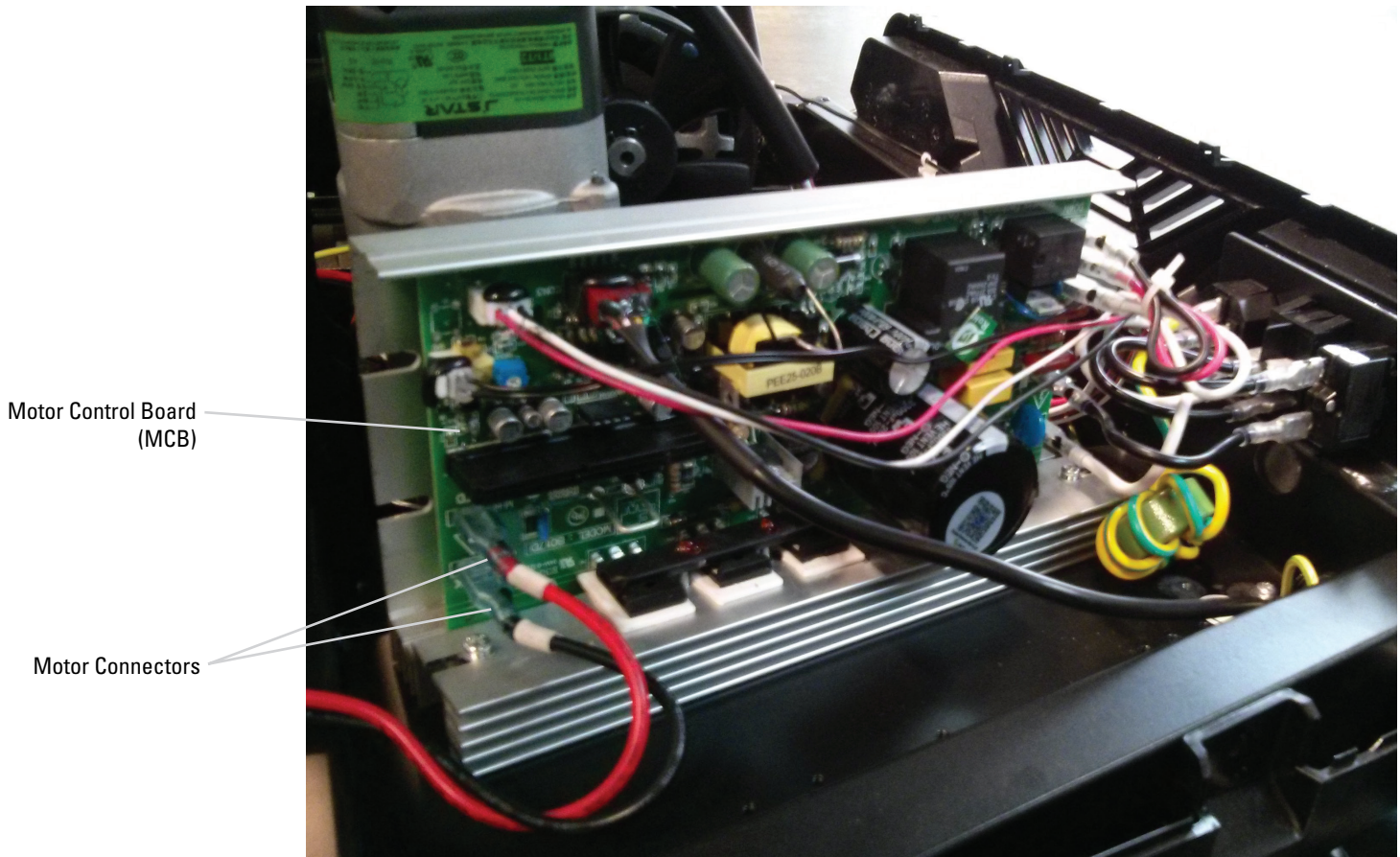

9. Using a #2 Phillips screwdriver, disconnect the Motor Ground Wire from the Frame.

10. Using a 6mm hex wrench, loosen the indicated screws (by arrows) on the Motor Mount.

11. Using a 13mm Open Ended Wrench, rotate the Belt Tensioner Screw enough to loosen the Drive Belt.

**Note:** To assist with reassembly, be sure to record the number of threads exposed before loosening.

12. Using a 6mm hex wrench, remove the indicated screws (by arrows) from the Motor Mount. Remove the Drive Belt and rotate the Motor Assembly exposing the Motor Mount.

13. Cut the 3 Zip-Ties that secure the Motor Cables.

14. Using a 6mm hex wrench, remove the indicated hardware from the Motor Mount and remove the old Motor.

15. Attach the Motor Mount to the new Motor. Be sure the Belt Tensioner Screw is properly oriented toward the rear of the machine when the Motor is re-installed.

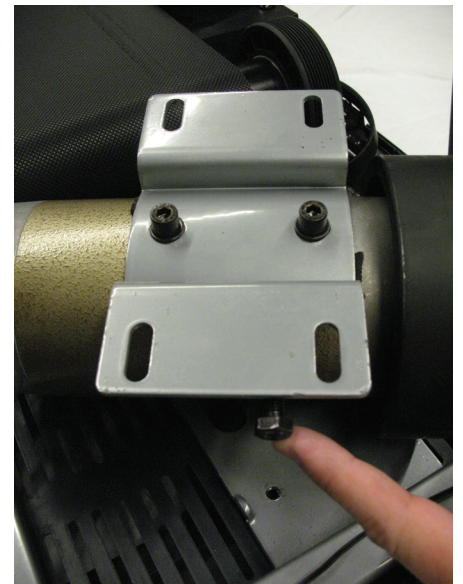
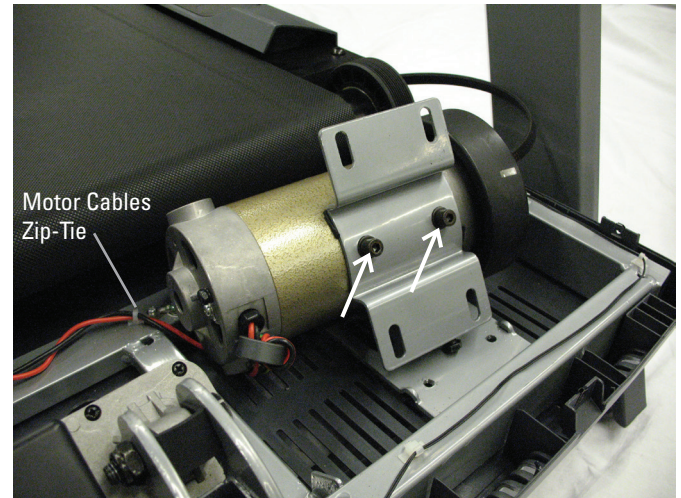
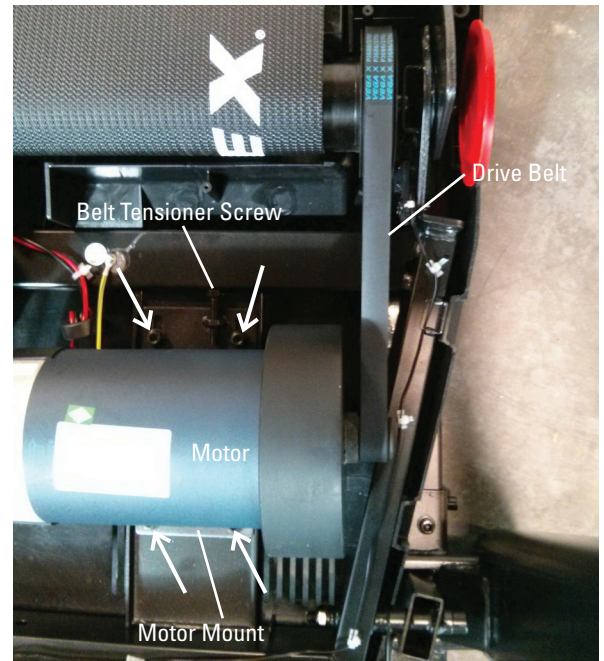



16. Lightly attach the Motor Assembly to the Frame. Be sure to only finger tighten the hardware.

17. Loop the Drive Belt onto the Motor Pulley. With the Drive Belt looped onto the Motor, carefully roll the Drive Belt onto the Drive Pulley.

18. Wrap the new Drive Belt around the Motor Pulley. Start the Drive Belt on the Drive Pulley and roll it in a clockwise motion. Be sure the Belt does not come off of the Motor Pulley.

**⚠ Keep fingers out of any pinch opportunities when turning the Pulleys.**

19. Roll the Drive Pulley clockwise until the Drive Belt is fully installed. Continue to roll the Belt forward while adding side pressure with fingers to align as necessary.

20. With the Motor Assembly loosely attached to the Frame, turn the Belt Tensioner Screw to the previous level. This will tighten the Drive Belt to the previous tension level.

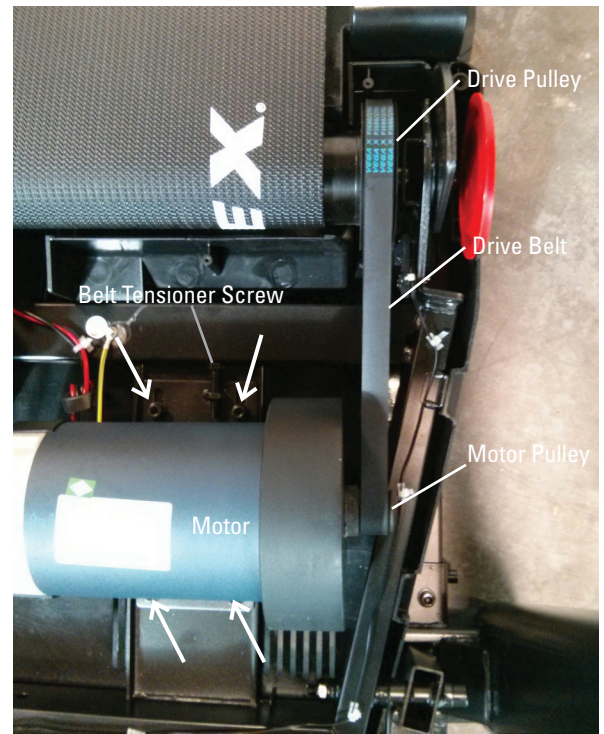

21. Using a 6mm hex wrench, fully tighten the screws that attach the Motor Assembly to the Frame.

22. Connect the Motor Connectors to the Motor Control Board following the previous route.

**Note:** Be sure to attach the cables to the proper locations on the Motor Control Board. Do not crimp any cables.

23. Secure the Motor Cables using the replacement Zip-Ties.

24. Re-install all remaining parts that were removed in reverse order.

25. Attach the power cord and turn on the Treadmill by flipping the power switch to ON.

26. From the Power Up (or Welcome) screen, push and hold down the PAUSE/STOP button and Down arrow button for about 5 seconds to go into the Machine Setting Mode. The Console display will show the TOTAL HOURS screen.

27. Push and hold down the PAUSE/STOP button and Down arrow button for about 5 seconds to go into the Engineering Mode.

28. Push the Down arrow button 14 times until the Console displays "ENTR MCB CLB".

**⚠ Be sure the area around the Treadmill is clear of all bystanders, children and pets. Be sure there is nothing on or under the Walking Belt, or near the Treadmill.**

29. The Console will display "MCB CALIB".

30. With the area clear, push the ENTER button. The calibration procedure will begin by automatically moving the Walking Belt.

**⚠ Be sure not to touch or allow anyone else to touch the machine while calibration is occurring.**

31. When calibration is complete, the Console will display "DONE".

32. Push the PAUSE/STOP button to exit the Engineering Mode.

33. Flip the power switch to OFF. Calibration is now complete for the machine.

34. Final Inspection

Inspect your machine to ensure that all hardware is tight and components are properly assembled.



**Do not use until the machine has been fully assembled and inspected for correct performance in accordance with the Owner's Manual.**

**NOTICE:** This document provides instructions for the replacement of the Motor Control Board on the Bowflex® BXT116 / BXT216 Treadmills.

**If you need assistance, please call Bowflex Customer Service at 1-800-605-3369.**

 **This icon means a potentially hazardous situation which, if not avoided, could result in death or serious injury. Read and understand all Warnings on this machine.**

Nautilus, Inc., www.NautilusInc.com - Customer Service: North America (800) 605-3369, csnl@nautilus.com | outside U.S. www.nautilusinternational.com | Printed in China | © 2017 Nautilus, Inc. | ® indicates trademarks registered in the United States. These marks may be registered in other nations or otherwise protected by common law. Bowflex and the B logo are trademarks owned by or licensed to Nautilus, Inc.

### Important Safety Instructions - Before servicing or using this equipment, obey the following warnings:

 **This icon means a potentially hazardous situation which, if not avoided, could result in death or serious injury. Read and understand all Warnings on this machine.**

**⚠ DANGER** To reduce the risk of electrical shock or unsupervised usage of the equipment, always unplug the power cord from the wall outlet and wait 5 minutes before cleaning, maintaining or repairing this machine. Place the power cord in a secure location.

- Read and understand the Part Replacement Procedure before working on the machine. Failure to obey the instructions and safety warnings could cause injury to the service technician or bystanders.
- Keep bystanders, children and pets away from the product being serviced at all times.
- Make sure that the repair is done in an appropriate work space away from foot traffic and exposure to bystanders.
- Disconnect all power and allow to sit for 5 minutes before you service this machine.
- Some components of the equipment can be heavy or awkward. Enlist the service of a second person when you do maintenance steps involving these components. Do not try to do heavy or awkward steps on your own.
- If replacement parts are necessary, use only genuine Nautilus replacement parts and hardware. Failure to use genuine replacement parts can cause a risk to users, keep the machine from operating correctly and will void the warranty.
- Be sure that all warning stickers and instructional placards applied to the product stay present and in good condition when doing maintenance or replacing components. If necessary request replacement warning stickers or placards from Nautilus customer service.
- Do not try to change the design or functionality of the machine being serviced as this can adversely effect user safety and will void the warranty.
- Do not use the machine until all shrouds, instructions, warning labels and correct functionality have been verified and tested for correct performance.

### Tools Required (not included)

#2 Phillips screwdriver (short)

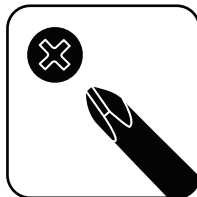

**Note:** The Bowflex® BXT116 is used in the following images. The procedure is the same for the BXT216 model.

1. With power supplied to the machine and it turned on, adjust the Walking Deck Incline to a setting of '6'. To adjust, push the '6' Pre-Set Incline button, and then the Confirm Incline button. Allow the Walking Deck to adjust to the new incline height.

2. Unplug the power cord from the machine and wait 5 minutes. Place the power cord in a secure location.

**⚠ DANGER** To reduce the risk of electrical shock or unsupervised usage of the equipment, always unplug the power cord from the wall outlet and wait 5 minutes before cleaning, maintaining or repairing this machine. Place the power cord in a secure location.

3. Using a #2 Phillips screwdriver, remove the screw (indicated by ovals) from each of the Base Shrouds.

4. Remove the Base Shrouds from the machine.

5. Using a #2 Phillips screwdriver, remove the 10 indicated screws that secure the Motor Cover.

**Note:** There are 2 screws that secure the Motor Cover from the underside of the machine (see image to the right).

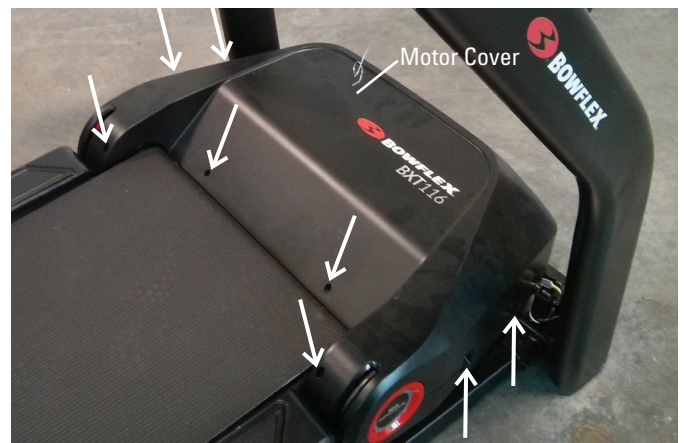

6. Gently release the front snaps (indicated by ovals) that secure the Motor Cover and pivot it back toward the walking belt until it releases. Remove from the machine.



7. Using a #2 Phillips screwdriver, remove the 2 indicated screws from the Motor Control Board Cover. Lift and remove the Motor Control Board Cover.

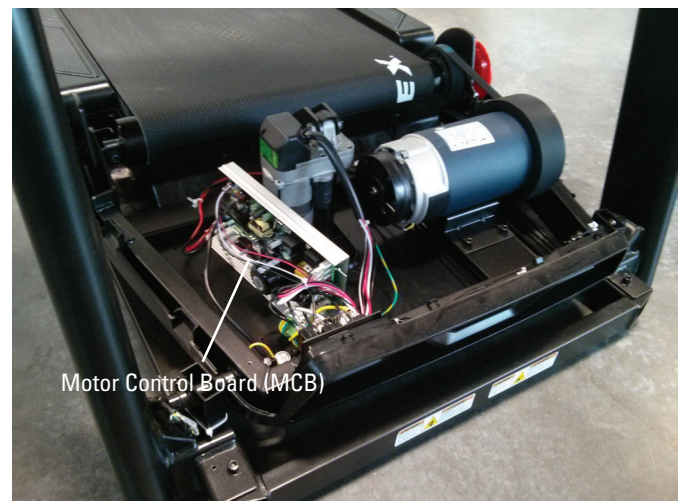
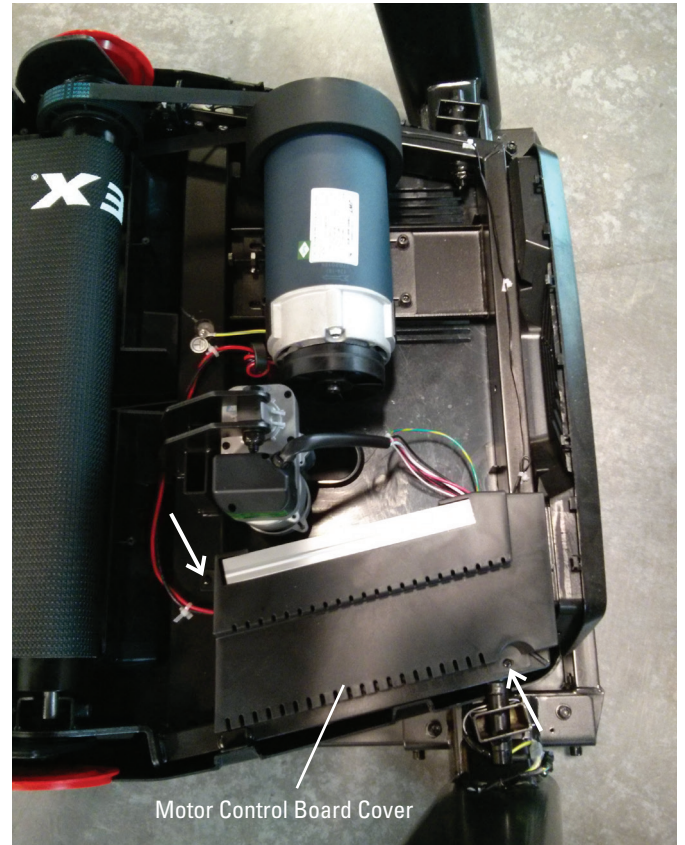

8. Remove the connectors from the Motor Control Board after noting their locations.

**Note:** Be sure to note where all cables attach for re-assembly.

9. Using a #2 Phillips screwdriver, remove the 2 indicated screws that attach the Motor Control Board (MCB) to the Frame.

10. Remove the old Motor Control Board, and install the new Motor Control Board. Connect all the cables to the MCB in their proper locations. Be sure not to crimp any cables.

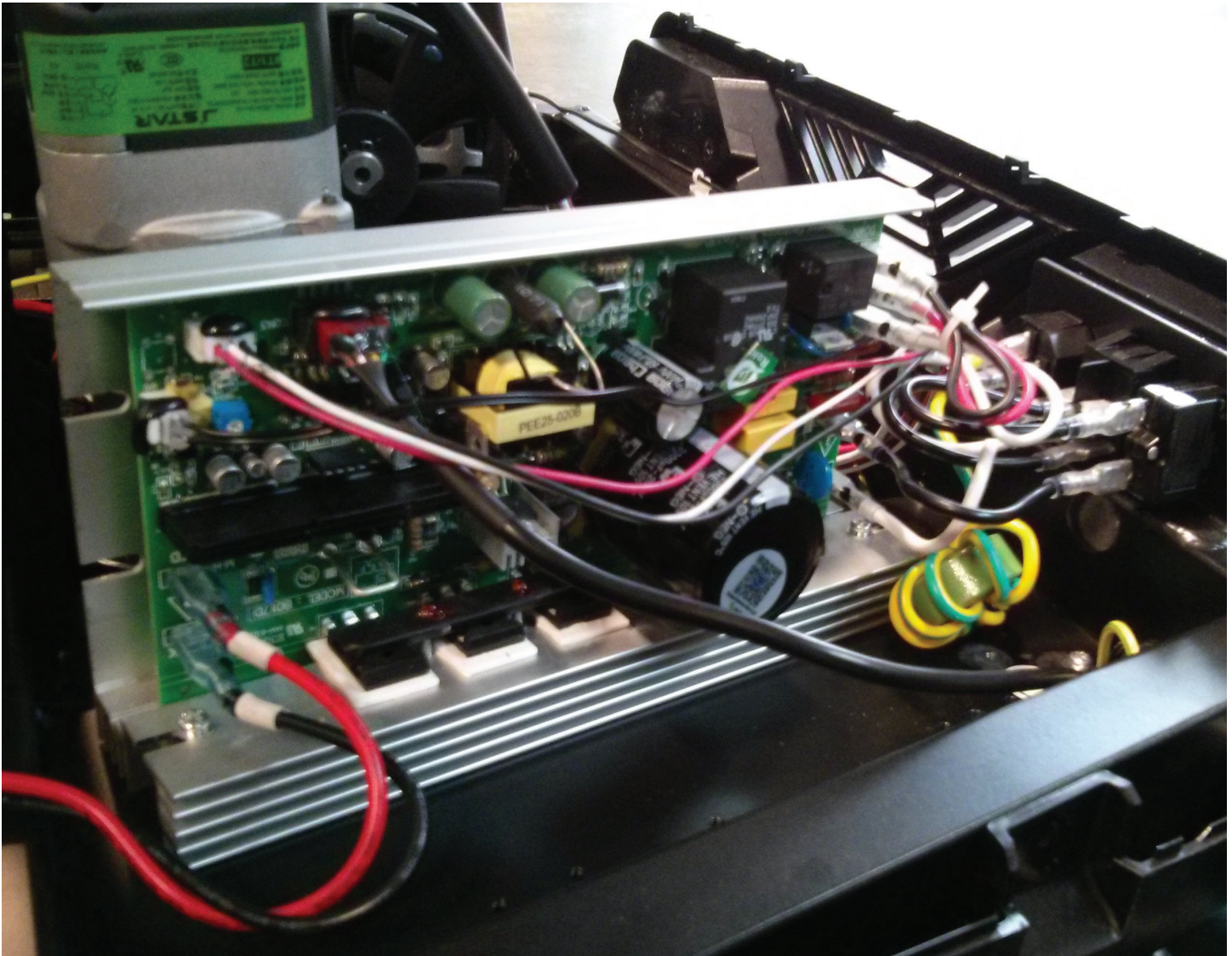
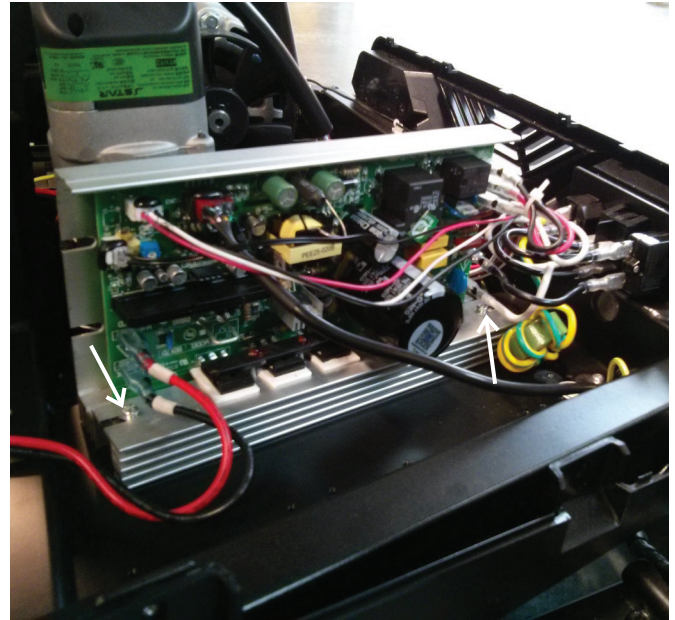

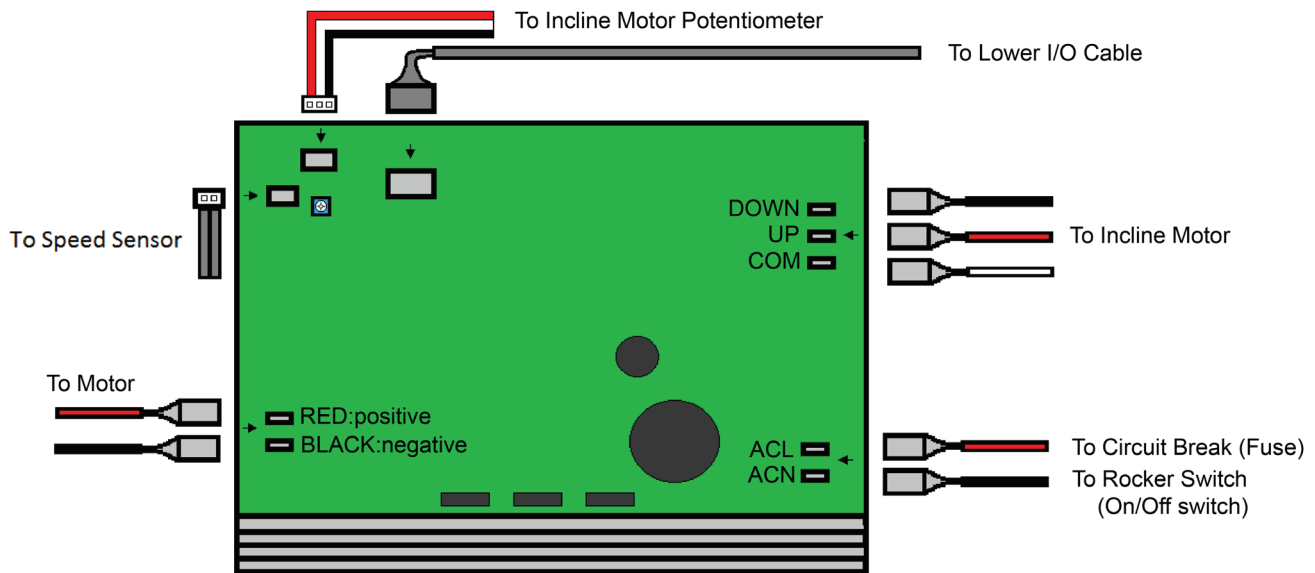

11. Re-install all remaining parts that were removed in reverse order.

12. Attach the power cord and turn on the Treadmill by flipping the power switch to ON.

13. From the Power Up (or Welcome) screen, push and hold down the PAUSE/STOP button and Down arrow button for about 5 seconds to go into the Machine Setting Mode. The Console display will show the TOTAL HOURS screen.

14. Push and hold down the PAUSE/STOP button and Down arrow button for about 5 seconds to go into the Engineering Mode.

15. Push the Down arrow button 14 times until the Console displays "ENTR MCB CLB".

**⚠ Be sure the area around the Treadmill is clear of all bystanders, children and pets. Be sure there is nothing on or under the Walking Belt, or near the Treadmill.**

16. The Console will display "MCB CALIB".

17. With the area clear, push the ENTER button. The calibration procedure will begin by automatically moving the Walking Belt.

**⚠ Be sure not to touch or allow anyone else to touch the machine while calibration is occurring.**

18. When calibration is complete, the Console will display "DONE".

19. Push the PAUSE/STOP button to exit the Engineering Mode.

20. Flip the power switch to OFF. Calibration is now complete for the machine.

21. Final Inspection

Inspect your machine to ensure that all hardware is tight and components are properly assembled.

**⚠ Do not use until the machine has been fully assembled and inspected for correct performance in accordance with the Owner's Manual.**

**NOTICE:** This document provides instructions for the replacement of the Motor Control Board Cover on the Bowflex® BXT116 / BXT216 Treadmills.

**If you need assistance, please call Bowflex Customer Service at 1-800-605-3369.**

 **This icon means a potentially hazardous situation which, if not avoided, could result in death or serious injury. Read and understand all Warnings on this machine.**

Nautilus, Inc., www.NautilusInc.com - Customer Service: North America (800) 605-3369, csnl@nautilus.com | outside U.S. www.nautilusinternational.com | Printed in China | © 2017 Nautilus, Inc. | ® indicates trademarks registered in the United States. These marks may be registered in other nations or otherwise protected by common law. Bowflex and the B logo are trademarks owned by or licensed to Nautilus, Inc.

### Important Safety Instructions - Before servicing or using this equipment, obey the following warnings:

 **This icon means a potentially hazardous situation which, if not avoided, could result in death or serious injury. Read and understand all Warnings on this machine.**

**DANGER** **To reduce the risk of electrical shock or unsupervised usage of the equipment, always unplug the power cord from the wall outlet and wait 5 minutes before cleaning, maintaining or repairing this machine. Place the power cord in a secure location.**

- Read and understand the Part Replacement Procedure before working on the machine. Failure to obey the instructions and safety warnings could cause injury to the service technician or bystanders.
- Keep bystanders, children and pets away from the product being serviced at all times.
- Make sure that the repair is done in an appropriate work space away from foot traffic and exposure to bystanders.
- Disconnect all power and allow to sit for 5 minutes before you service this machine.
- Some components of the equipment can be heavy or awkward. Enlist the service of a second person when you do maintenance steps involving these components. Do not try to do heavy or awkward steps on your own.
- If replacement parts are necessary, use only genuine Nautilus replacement parts and hardware. Failure to use genuine replacement parts can cause a risk to users, keep the machine from operating correctly and will void the warranty.
- Be sure that all warning stickers and instructional placards applied to the product stay present and in good condition when doing maintenance or replacing components. If necessary request replacement warning stickers or placards from Nautilus customer service.
- Do not try to change the design or functionality of the machine being serviced as this can adversely effect user safety and will void the warranty.
- Do not use the machine until all shrouds, instructions, warning labels and correct functionality have been verified and tested for correct performance.

#### Tools Required (not included)

#2 Phillips screwdriver (short)

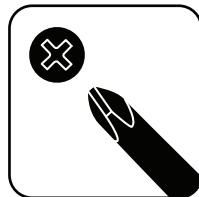



**Note:** The Bowflex® BXT116 is used in the following images. The procedure is the same for the BXT216 model.

1. With power supplied to the machine and it turned on, adjust the Walking Deck Incline to a setting of '6'. To adjust, push the '6' Pre-Set Incline button, and then the Confirm Incline button. Allow the Walking Deck to adjust to the new incline height.

2. Unplug the power cord from the machine and wait 5 minutes. Place the power cord in a secure location.

**⚠ DANGER** To reduce the risk of electrical shock or unsupervised usage of the equipment, always unplug the power cord from the wall outlet and wait 5 minutes before cleaning, maintaining or repairing this machine. Place the power cord in a secure location.

3. Using a #2 Phillips screwdriver, remove the screw (indicated by ovals) from each of the Base Shrouds.

4. Remove the Base Shrouds from the machine.

5. Using a #2 Phillips screwdriver, remove the 10 indicated screws that secure the Motor Cover.

**Note:** There are 2 screws that secure the Motor Cover from the underside of the machine (see image to the right).

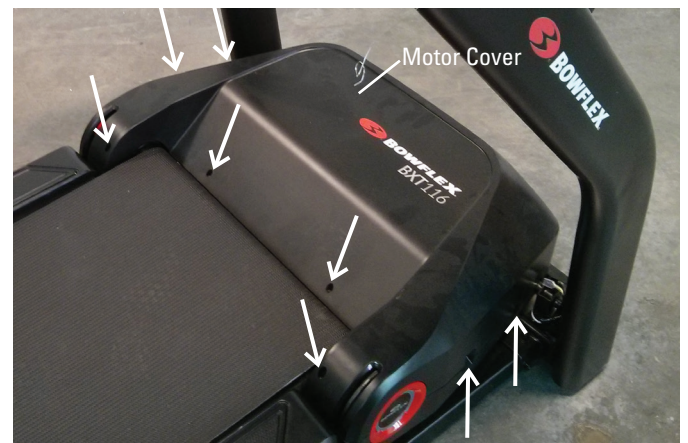

6. Gently release the front snaps (indicated by ovals) that secure the Motor Cover and pivot it back toward the walking belt until it releases. Remove from the machine.



7. Using a #2 Phillips screwdriver, remove the 2 indicated screws from the Motor Control Board Cover. Lift and remove the Motor Control Board Cover.

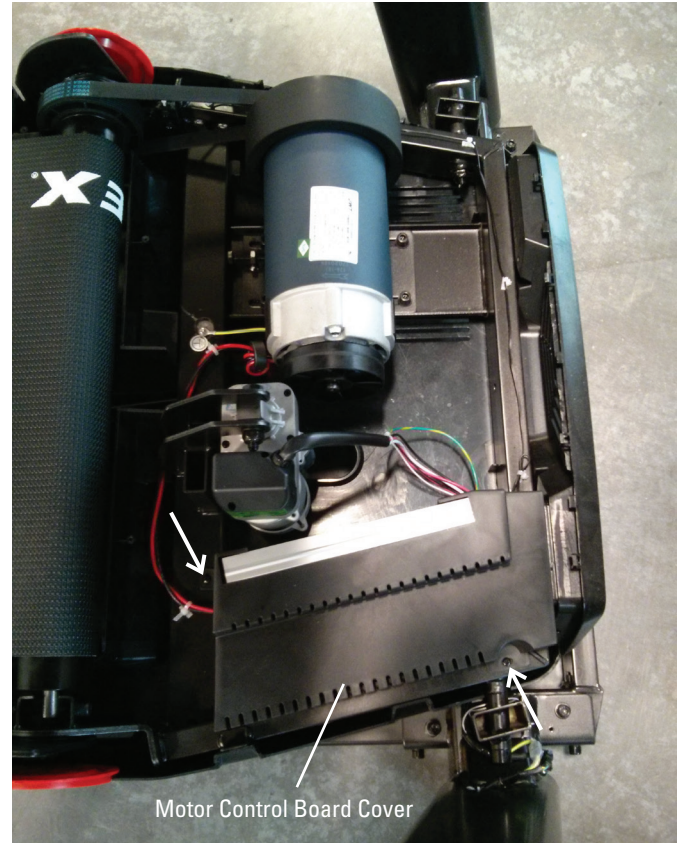

8. Re-install the parts that were removed in reverse order.

9. Final Inspection  
Inspect your machine to ensure that all hardware is tight and components are properly assembled.

 Do not use until the machine has been fully assembled and inspected for correct performance in accordance with the Owner's Manual.

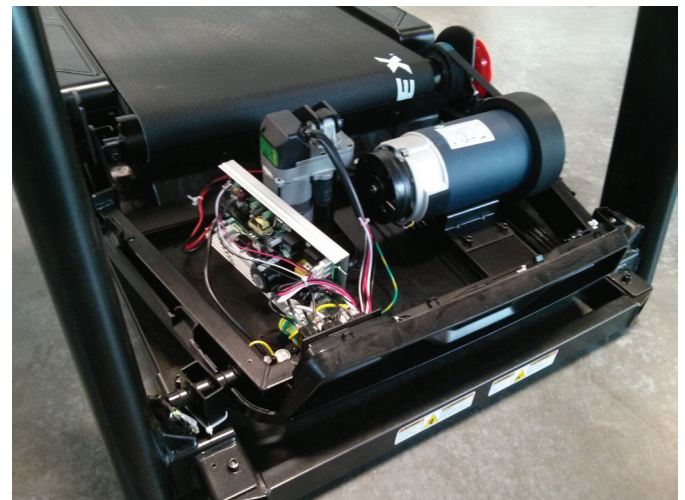

**NOTICE:** This document provides instructions for the replacement of the Motor Cover on the Bowflex® BXT116 / BXT216 Treadmills.

**If you need assistance, please call Bowflex Customer Service at 1-800-605-3369.**

 **This icon means a potentially hazardous situation which, if not avoided, could result in death or serious injury. Read and understand all Warnings on this machine.**

Nautilus, Inc., www.NautilusInc.com - Customer Service: North America (800) 605-3369, csnl@nautilus.com | outside U.S. www.nautilusinternational.com | Printed in China | © 2017 Nautilus, Inc. | ® indicates trademarks registered in the United States. These marks may be registered in other nations or otherwise protected by common law. Bowflex and the B logo are trademarks owned by or licensed to Nautilus, Inc.

### Important Safety Instructions - Before servicing or using this equipment, obey the following warnings:

 **This icon means a potentially hazardous situation which, if not avoided, could result in death or serious injury. Read and understand all Warnings on this machine.**

**DANGER** **To reduce the risk of electrical shock or unsupervised usage of the equipment, always unplug the power cord from the wall outlet and wait 5 minutes before cleaning, maintaining or repairing this machine. Place the power cord in a secure location.**

- Read and understand the Part Replacement Procedure before working on the machine. Failure to obey the instructions and safety warnings could cause injury to the service technician or bystanders.
- Keep bystanders, children and pets away from the product being serviced at all times.
- Make sure that the repair is done in an appropriate work space away from foot traffic and exposure to bystanders.
- Disconnect all power and allow to sit for 5 minutes before you service this machine.
- Some components of the equipment can be heavy or awkward. Enlist the service of a second person when you do maintenance steps involving these components. Do not try to do heavy or awkward steps on your own.
- If replacement parts are necessary, use only genuine Nautilus replacement parts and hardware. Failure to use genuine replacement parts can cause a risk to users, keep the machine from operating correctly and will void the warranty.
- Be sure that all warning stickers and instructional placards applied to the product stay present and in good condition when doing maintenance or replacing components. If necessary request replacement warning stickers or placards from Nautilus customer service.
- Do not try to change the design or functionality of the machine being serviced as this can adversely effect user safety and will void the warranty.
- Do not use the machine until all shrouds, instructions, warning labels and correct functionality have been verified and tested for correct performance.

### Tools Required (not included)

#2 Phillips screwdriver (short)

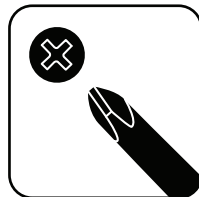

**Note:** The Bowflex® BXT116 is used in the following images. The procedure is the same for the BXT216 model.

1. With power supplied to the machine and it turned on, adjust the Walking Deck Incline to a setting of '6'. To adjust, push the '6' Pre-Set Incline button, and then the Confirm Incline button. Allow the Walking Deck to adjust to the new incline height.

2. Unplug the power cord from the machine and wait 5 minutes. Place the power cord in a secure location.

**⚠ DANGER** To reduce the risk of electrical shock or unsupervised usage of the equipment, always unplug the power cord from the wall outlet and wait 5 minutes before cleaning, maintaining or repairing this machine. Place the power cord in a secure location.

3. Using a #2 Phillips screwdriver, remove the screw (indicated by ovals) from each of the Base Shrouds.

4. Remove the Base Shrouds from the machine.

5. Using a #2 Phillips screwdriver, remove the 10 indicated screws that secure the Motor Cover.

**Note:** There are 2 screws that secure the Motor Cover from the underside of the machine (see image to the right).

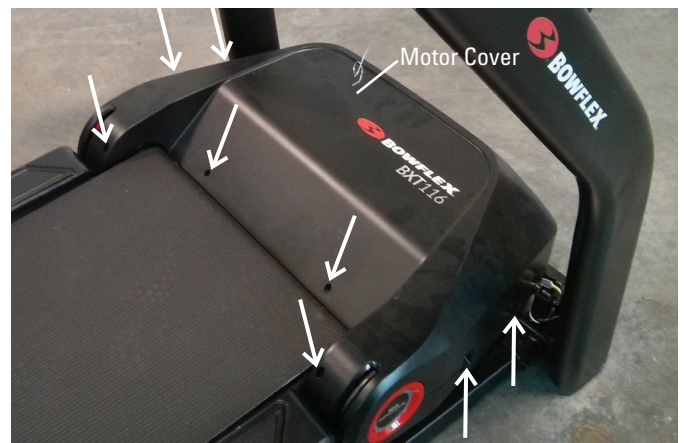

6. Gently release the front snaps (indicated by ovals) that secure the Motor Cover and pivot it back toward the walking belt until it releases. Remove from the machine.



7. Re-install the parts that were removed in reverse order.

#### 8. Final Inspection

Inspect your machine to ensure that all hardware is tight and components are properly assembled.



**Do not use until the machine has been fully assembled and inspected for correct performance in accordance with the Owner's Manual.**

**NOTICE:** This document provides instructions for the replacement of the Motor Mount on the Bowflex® BXT116 / BXT216 Treadmills.

**If you need assistance, please call Bowflex Customer Service at 1-800-605-3369.**

**This icon means a potentially hazardous situation which, if not avoided, could result in death or serious injury. Read and understand all Warnings on this machine.**

Nautilus, Inc., www.NautilusInc.com - Customer Service: North America (800) 605-3369, csnl@s@nautilus.com | outside U.S. www.nautilusinternational.com | Printed in China | © 2017 Nautilus, Inc. | ® indicates trademarks registered in the United States. These marks may be registered in other nations or otherwise protected by common law. Bowflex and the B logo are trademarks owned by or licensed to Nautilus, Inc.

### Important Safety Instructions - Before servicing or using this equipment, obey the following warnings:

**This icon means a potentially hazardous situation which, if not avoided, could result in death or serious injury. Read and understand all Warnings on this machine.**

**DANGER** **To reduce the risk of electrical shock or unsupervised usage of the equipment, always unplug the power cord from the wall outlet and wait 5 minutes before cleaning, maintaining or repairing this machine. Place the power cord in a secure location.**

- Read and understand the Part Replacement Procedure before working on the machine. Failure to obey the instructions and safety warnings could cause injury to the service technician or bystanders.
- Keep bystanders, children and pets away from the product being serviced at all times.
- Make sure that the repair is done in an appropriate work space away from foot traffic and exposure to bystanders.
- Disconnect all power and allow to sit for 5 minutes before you service this machine.
- Some components of the equipment can be heavy or awkward. Enlist the service of a second person when you do maintenance steps involving these components. Do not try to do heavy or awkward steps on your own.
- If replacement parts are necessary, use only genuine Nautilus replacement parts and hardware. Failure to use genuine replacement parts can cause a risk to users, keep the machine from operating correctly and will void the warranty.
- Be sure that all warning stickers and instructional placards applied to the product stay present and in good condition when doing maintenance or replacing components. If necessary request replacement warning stickers or placards from Nautilus customer service.
- Do not try to change the design or functionality of the machine being serviced as this can adversely effect user safety and will void the warranty.
- Do not use the machine until all shrouds, instructions, warning labels and correct functionality have been verified and tested for correct performance.

### Tools Required (not included)

#2 Phillips screwdriver

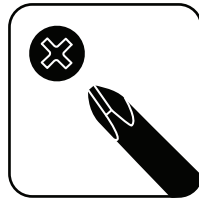

6mm Hex Wrench



13mm Wrench



**Note:** The Bowflex® BXT116 is used in the following images. The procedure is the same for the BXT216 model.

1. With power supplied to the machine and it turned on, adjust the Walking Deck Incline to a setting of '6'. To adjust, push the '6' Pre-Set Incline button, and then the Confirm Incline button. Allow the Walking Deck to adjust to the new incline height.

2. Unplug the power cord from the machine and wait 5 minutes. Place the power cord in a secure location.

**⚠ DANGER** To reduce the risk of electrical shock or unsupervised usage of the equipment, always unplug the power cord from the wall outlet and wait 5 minutes before cleaning, maintaining or repairing this machine. Place the power cord in a secure location.

3. Using a #2 Phillips screwdriver, remove the screw (indicated by ovals) from each of the Base Shrouds.

4. Remove the Base Shrouds from the machine.

5. Using a #2 Phillips screwdriver, remove the 10 indicated screws that secure the Motor Cover.

**Note:** There are 2 screws that secure the Motor Cover from the underside of the machine (see image to the right).

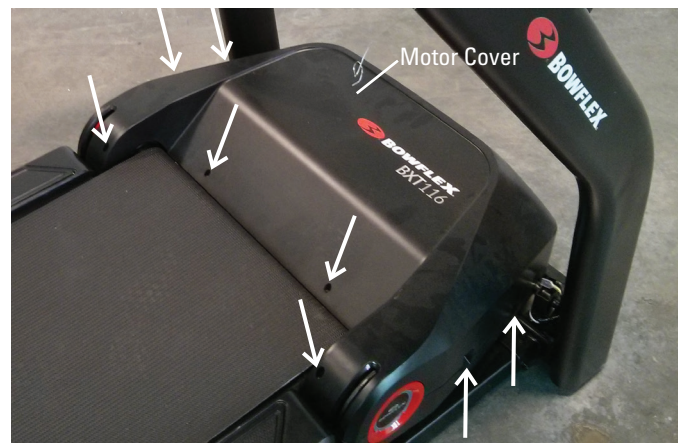

6. Gently release the front snaps (indicated by ovals) that secure the Motor Cover and pivot it back toward the walking belt until it releases. Remove from the machine.



7. Using a 6mm hex wrench, loosen the indicated screws (by arrows) on the Motor Mount.

8. Using a 13mm Open Ended Wrench, rotate the Belt Tensioner Screw enough to loosen the Drive Belt.  
**Note:** To assist with reassembly, be sure to record the number of threads exposed before loosening.

9. Using a 6mm hex wrench, remove the indicated screws from the Motor Mount. Remove the Drive Belt and rotate the Motor Assembly exposing the Motor Mount.

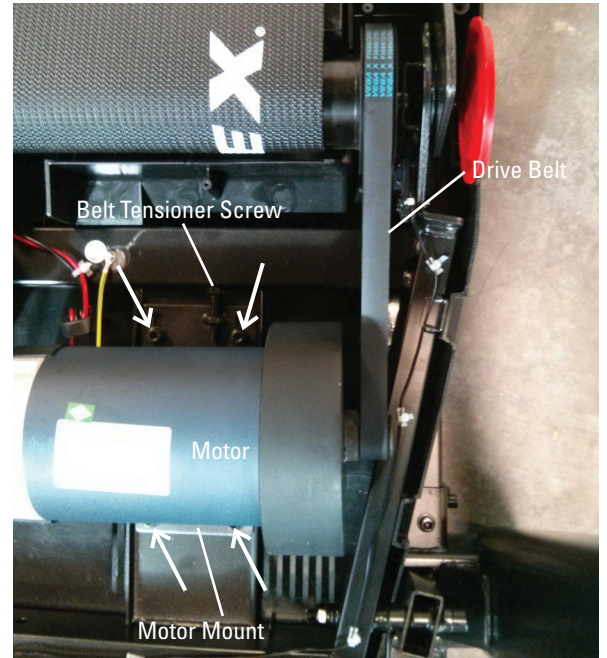

10. Using a 6mm hex wrench, remove the indicated hardware from the Motor Mount.

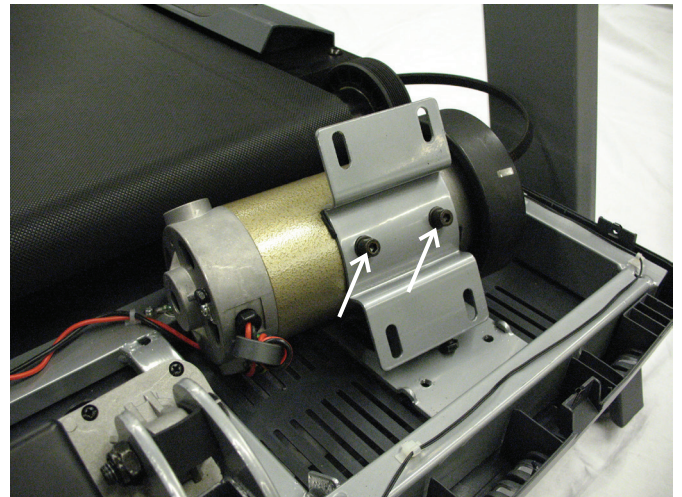



11. Attach the new Motor Mount to the Motor. Be sure the Belt Tensioner Screw is properly oriented toward the rear of the machine when the Motor is re-installed.

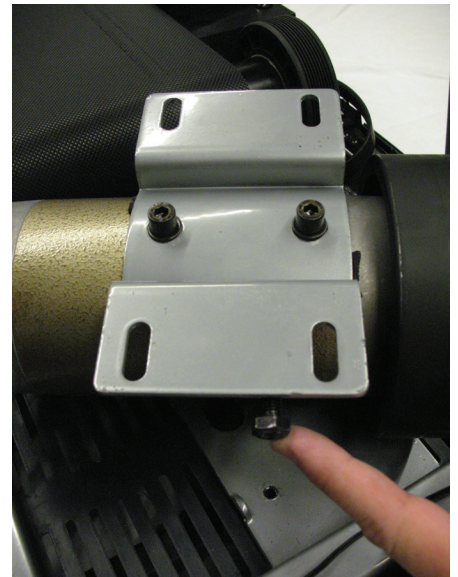

12. Lightly attach the Motor Assembly to the Frame. Be sure to only finger tighten the hardware.

13. Loop the Drive Belt onto the Motor Pulley. With the Drive Belt looped onto the Motor, carefully roll the Drive Belt onto the Drive Pulley in a clockwise motion. Be sure the Belt does not come off of the Motor Pulley.

 **Keep fingers out of any pinch opportunities when turning the Pulleys.**

14. Roll the Drive Pulley clockwise until the Drive Belt is fully installed. Continue to roll the Belt forward while adding side pressure with fingers to align as necessary.

15. With the Motor Assembly loosely attached to the Frame, turn the Belt Tensioner Screw to the previous level. This will tighten the Drive Belt to the previous tension level.

16. Using a 6mm hex wrench, fully tighten the screws that attach the Motor Assembly to the Frame.

17. Re-install all remaining parts that were removed in reverse order.

18. Attach the power cord and turn on the Treadmill by flipping the power switch to ON.

19. From the Power Up (or Welcome) screen, push and hold down the PAUSE/STOP button and Down arrow button for about 5 seconds to go into the Machine Setting Mode. The Console display will show the TOTAL HOURS screen.

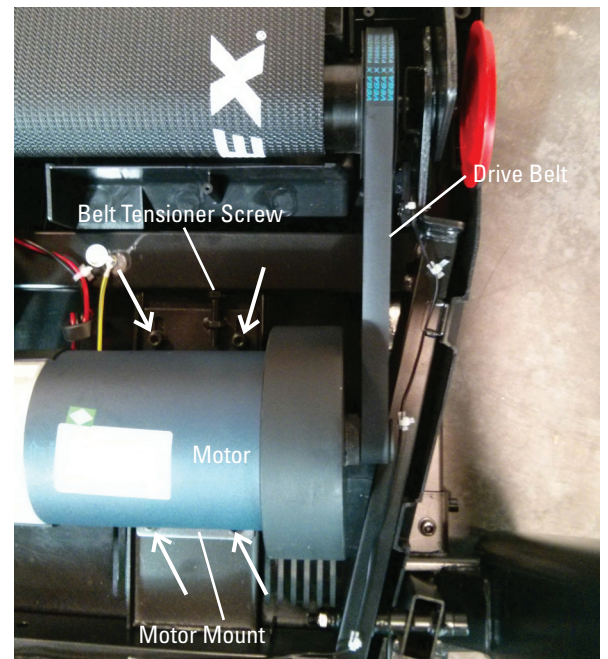

20. Push and hold down the PAUSE/STOP button and Down arrow button for about 5 seconds to go into the Engineering Mode.

21. Push the Down arrow button 14 times until the Console displays “ENTR MCB CLB”.

 **Be sure the area around the Treadmill is clear of all bystanders, children and pets. Be sure there is nothing on or under the Walking Belt, or near the Treadmill.**

22. The Console will display “MCB CALIB”.

23. With the area clear, push the ENTER button. The calibration procedure will begin by automatically moving the Walking Belt.

 **Be sure not to touch or allow anyone else to touch the machine while calibration is occurring.**

24. When calibration is complete, the Console will display “DONE”.

25. Push the PAUSE/STOP button to exit the Engineering Mode.

26. Flip the power switch to OFF. Calibration is now complete for the machine.

27. Final Inspection

Inspect your machine to ensure that all hardware is tight and components are properly assembled.

 **Do not use until the machine has been fully assembled and inspected for correct performance in accordance with the Owner’s Manual.**

**NOTICE:** This document provides instructions for the replacement of the Power Inlet on the Bowflex® BXT116 / BXT216 Treadmills.

**If you need assistance, please call Bowflex Customer Service at 1-800-605-3369.**

 **This icon means a potentially hazardous situation which, if not avoided, could result in death or serious injury. Read and understand all Warnings on this machine.**

Nautilus, Inc., www.NautilusInc.com - Customer Service: North America (800) 605-3369, csnl@nautilus.com | outside U.S. www.nautilusinternational.com | Printed in China | © 2017 Nautilus, Inc. | ® indicates trademarks registered in the United States. These marks may be registered in other nations or otherwise protected by common law. Bowflex and the B logo are trademarks owned by or licensed to Nautilus, Inc.

### Important Safety Instructions - Before servicing or using this equipment, obey the following warnings:

 **This icon means a potentially hazardous situation which, if not avoided, could result in death or serious injury. Read and understand all Warnings on this machine.**

**DANGER** **To reduce the risk of electrical shock or unsupervised usage of the equipment, always unplug the power cord from the wall outlet and wait 5 minutes before cleaning, maintaining or repairing this machine. Place the power cord in a secure location.**

- Read and understand the Part Replacement Procedure before working on the machine. Failure to obey the instructions and safety warnings could cause injury to the service technician or bystanders.
- Keep bystanders, children and pets away from the product being serviced at all times.
- Make sure that the repair is done in an appropriate work space away from foot traffic and exposure to bystanders.
- Disconnect all power and allow to sit for 5 minutes before you service this machine.
- Some components of the equipment can be heavy or awkward. Enlist the service of a second person when you do maintenance steps involving these components. Do not try to do heavy or awkward steps on your own.
- If replacement parts are necessary, use only genuine Nautilus replacement parts and hardware. Failure to use genuine replacement parts can cause a risk to users, keep the machine from operating correctly and will void the warranty.
- Be sure that all warning stickers and instructional placards applied to the product stay present and in good condition when doing maintenance or replacing components. If necessary request replacement warning stickers or placards from Nautilus customer service.
- Do not try to change the design or functionality of the machine being serviced as this can adversely effect user safety and will void the warranty.
- Do not use the machine until all shrouds, instructions, warning labels and correct functionality have been verified and tested for correct performance.

### Tools Required (not included)

#2 Phillips screwdriver (short)

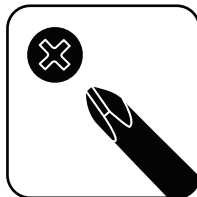

**Note:** The Bowflex® BXT116 is used in the following images. The procedure is the same for the BXT216 model.

1. With power supplied to the machine and it turned on, adjust the Walking Deck Incline to a setting of '6'. To adjust, push the '6' Pre-Set Incline button, and then the Confirm Incline button. Allow the Walking Deck to adjust to the new incline height.

2. Unplug the power cord from the machine and wait 5 minutes. Place the power cord in a secure location.

**⚠ DANGER** To reduce the risk of electrical shock or unsupervised usage of the equipment, always unplug the power cord from the wall outlet and wait 5 minutes before cleaning, maintaining or repairing this machine. Place the power cord in a secure location.

3. Using a #2 Phillips screwdriver, remove the screw (indicated by ovals) from each of the Base Shrouds.

4. Remove the Base Shrouds from the machine.

5. Using a #2 Phillips screwdriver, remove the 10 indicated screws that secure the Motor Cover.

**Note:** There are 2 screws that secure the Motor Cover from the underside of the machine (see image to the right).



6. Gently release the front snaps (indicated by ovals) that secure the Motor Cover and pivot it back toward the walking belt until it releases. Remove from the machine.



7. Using a #2 Phillips screwdriver, remove the 2 indicated screws from the Motor Control Board Cover. Lift and remove the Motor Control Board Cover.

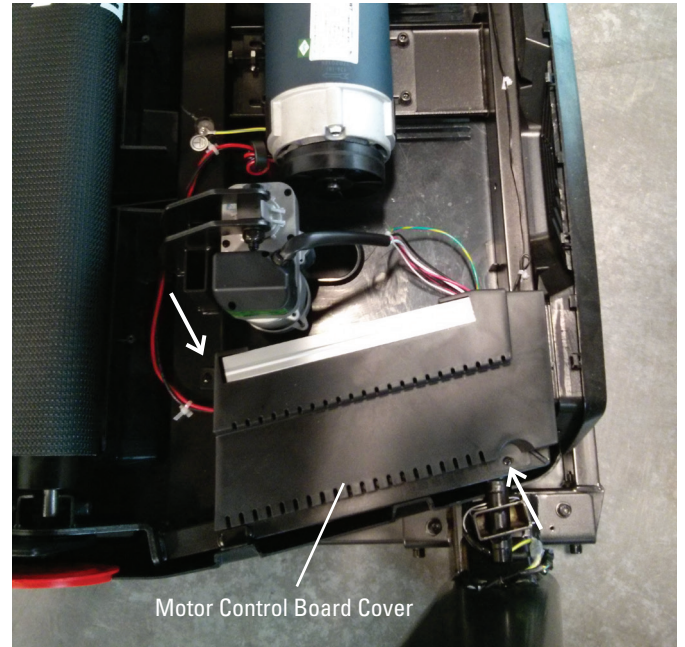

8. Release the Securing Clips from the Power Inlet and remove it from the Frame.

9. Remove the connectors and attach them to the new Power Inlet. Be sure to attach them in the same locations on the new Power Inlet.

10. Insert the new Power Inlet into the Frame being sure the Securing Clips engage.



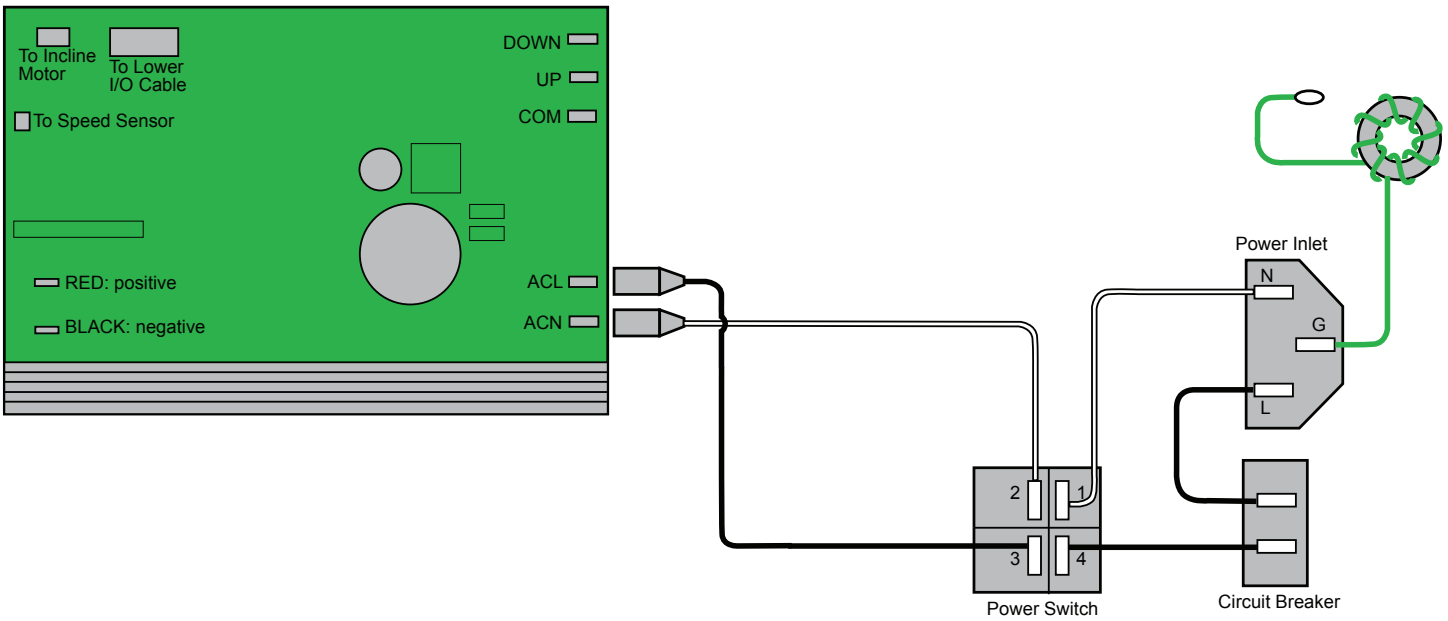
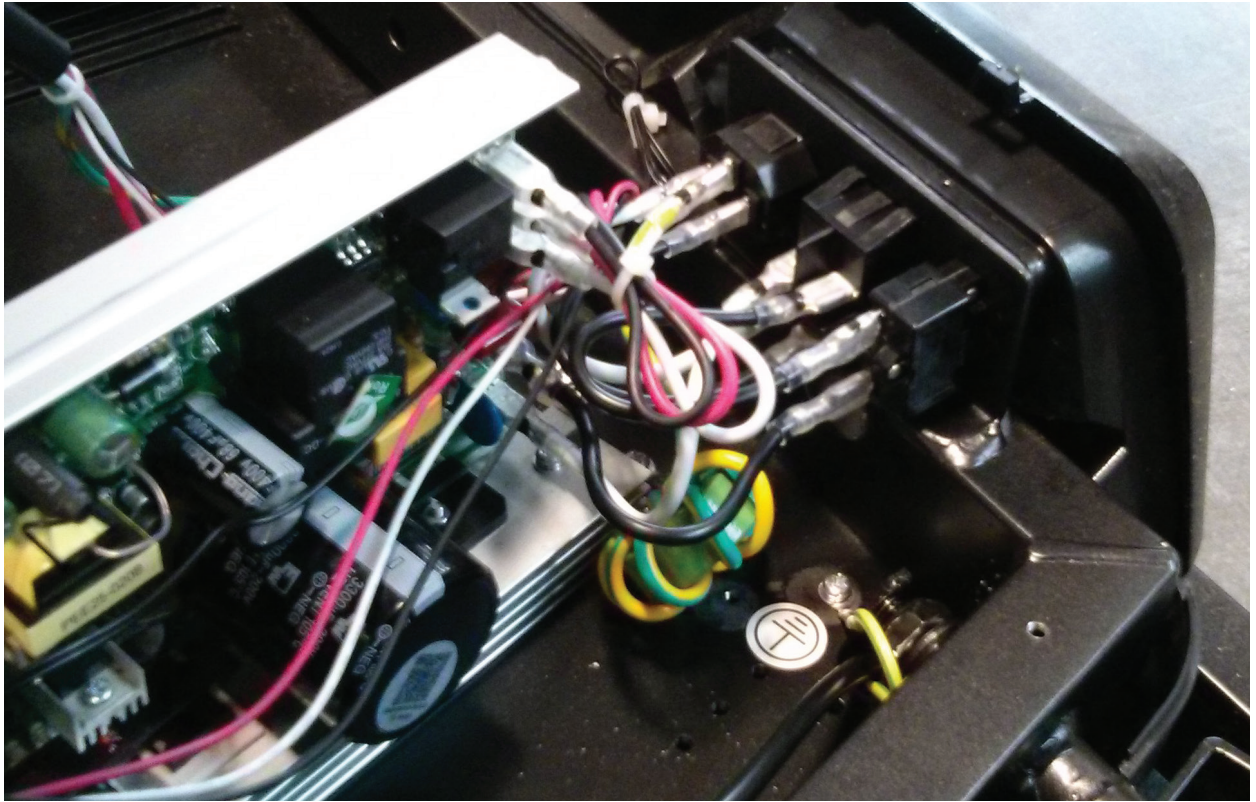

11. Re-install all remaining parts that were removed in reverse order.

12. Final Inspection

Inspect your machine to ensure that all hardware is tight and components are properly assembled.



**Do not use until the machine has been fully assembled and inspected for correct performance in accordance with the Owner's Manual.**

**NOTICE:** This document provides instructions to replace the Rear Roller on the Bowflex® BXT116 Treadmill.

**If you need assistance, please call Bowflex Customer Service at 1-800-605-3369.**

 **This icon means a potentially hazardous situation which, if not avoided, could result in death or serious injury. Read and understand all Warnings on this machine.**

Nautilus, Inc., (800) NAUTILUS / (800) 628-8458, www.NautilusInc.com - Customer Service: North America (800) 605-3369, csnl@nautilus.com | outside U.S. www.nautilusinternational.com | Printed in China | © 2017 Nautilus, Inc. | ® indicates trademarks registered in the United States. These marks may be registered in other nations or otherwise protected by common law. Bowflex and the B logo are trademarks owned by or licensed to Nautilus, Inc.

### Important Safety Instructions - Before servicing or using this equipment, obey the following warnings:

 **This icon means a potentially hazardous situation which, if not avoided, could result in death or serious injury. Read and understand all Warnings on this machine.**

**⚠ DANGER** To reduce the risk of electrical shock or unsupervised usage of the equipment, always unplug the power cord from the wall outlet and wait 5 minutes before cleaning, maintaining or repairing this machine. Place the power cord in a secure location.

- Read and understand the Part Replacement Procedure before working on the machine. Failure to obey the instructions and safety warnings could cause injury to the service technician or bystanders.
- Keep bystanders, children and pets away from the product being serviced at all times.
- Make sure that the repair is done in an appropriate work space away from foot traffic and exposure to bystanders.
- Disconnect all power and allow to sit for 5 minutes before you service this machine.
- Some components of the equipment can be heavy or awkward. Enlist the service of a second person when you do maintenance steps involving these components. Do not try to do heavy or awkward steps on your own.
- If replacement parts are necessary, use only genuine Nautilus replacement parts and hardware. Failure to use genuine replacement parts can cause a risk to users, keep the machine from operating correctly and will void the warranty.
- Be sure that all warning stickers and instructional placards applied to the product stay present and in good condition when doing maintenance or replacing components. If necessary request replacement warning stickers or placards from Nautilus customer service.
- Do not try to change the design or functionality of the machine being serviced as this can adversely effect user safety and will void the warranty.
- Do not use the machine until all shrouds, instructions, warning labels and correct functionality have been verified and tested for correct performance.

### Tools Required (not included)

#2 Phillips screwdriver

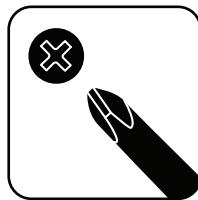

6mm hex wrench



**⚠ DANGER** To reduce the risk of electrical shock or unsupervised usage of the equipment, always unplug the power cord from the wall outlet and wait 5 minutes before cleaning, maintaining or repairing this machine. Place the power cord in a secure location.

1. Unplug the power cord from the machine and wait 5 minutes. Place the power cord in a secure location.

2. Make sure that there is safe clearance around, on and above the treadmill. Make sure there is no object to spill or cause blockage from the fully folded position.

**⚠** Be sure there is adequate height clearance for the raised deck.

3. Using the support bar found below the rear of the walking belt, push the Deck Release Handle and lift the walking deck fully upward and engage the hydraulic lift. Be sure that the hydraulic lift is correctly locked in place. You will hear an audible click when the hydraulic lift shifts into the locked position.

**⚠** Use proper safety precautions and lifting techniques. Bend your knees and elbows, keep your back straight and pull up equally with both arms. Straighten your legs to lift. Make sure that your own physical strength is capable of lifting the walking deck until it engages the locking mechanism. Use a second person if necessary.

Do not use the walking belt or rear roller to lift the treadmill. These parts do not lock in place and can abruptly move. Injury to you or damage to the machine can occur.

4. Make sure that the locking mechanism is engaged. Carefully pull back on the walking deck and make sure that it does not move. When you do this, keep clear of movement path in case the treadmill lock is not properly engaged.

**⚠** Do not lean against the treadmill when it is folded. Do not put items on it that could cause it to become unstable or fall.

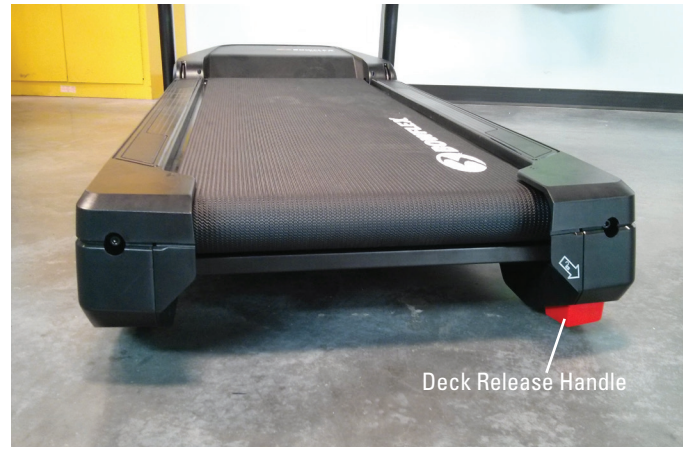



5. Using a #2 Phillips screwdriver, remove the two indicated screws from the Rear Roller Cover.

6. Remove the Rear Roller Cover noting how it attaches for re-assembly.



7. Using a #2 Phillips screwdriver, remove the 4 indicated screws that secure the Side Rail. Remove it from the machine.



8. Using a #2 Phillips screwdriver, remove the 4 indicated screws that secure the Lower Side Rail. Remove it from the machine.

9. Make sure there is sufficient space to lower the walking deck.

**⚠** Keep a minimum clearance behind the machine of 79" (2 m) and 24" (0.6 m) on each side. This is the recommended safe distance for access, movement and emergency dismounts from the machine.

10. Make sure there is no object on or around the treadmill to spill or cause blockage from the fully unfolded position.

11. Slightly push the walking deck forward toward the console, and then push the Deck Release Handle until the locking tube releases and you can pull the walking deck away from the console. Hold up the rear of the walking deck, and move to the side of the machine.

**⚠** Keep clear of the movement path of the walking deck.

12. The hydraulic lift is set up to drop gradually. Hold onto the walking deck until approximately 2/3 of the movement down. Make sure that you use proper lifting technique; bend your knees and keep your back straight. Lower the weight with your legs. Be aware that the walking deck can possibly drop quickly in the last part of the movement.

13. Using a 6mm hex wrench, remove the indicated Adjustment Bolts (with arrows) from the Rear Roller.

**Note:** Be sure to record the number of turns of the Adjustment Bolt it takes to remove it. This will assist with reassembly.

14. Slide the Rear Roller out of the Walking Belt.

15. Slide the new Rear Roller into the new Walking Belt in the same orientation.

16. Using a 6mm hex wrench, re-attach the Adjustment Bolt to the Rear Roller.

**Note:** Be sure to tighten the Adjustment Bolt the same number of turns it took to loosen the Walking Belt.

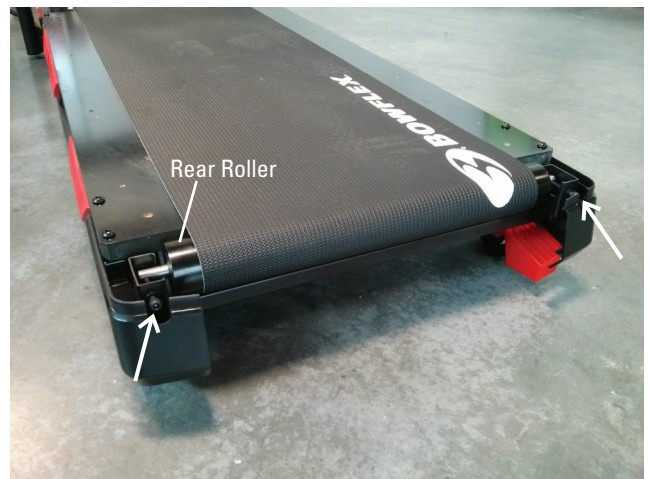

17. Re-install all remaining parts that were removed in reverse order.

18. Final Inspection

Inspect your machine to ensure that all hardware is tight and components are properly assembled.



**Do not use until the machine has been fully assembled and inspected for correct performance in accordance with the Owner's Manual.**

**NOTICE:** This document provides instructions to replace the Rear Roller Cover on the Bowflex® BXT116 Treadmill.

**If you need assistance, please call Bowflex Customer Service at 1-800-605-3369.**

 **This icon means a potentially hazardous situation which, if not avoided, could result in death or serious injury. Read and understand all Warnings on this machine.**

Nautilus, Inc., www.NautilusInc.com - Customer Service: North America (800) 605-3369, csnl@nautilus.com | outside U.S. www.nautilusinternational.com | Printed in China | © 2017 Nautilus, Inc. | ® indicates trademarks registered in the United States. These marks may be registered in other nations or otherwise protected by common law. Bowflex and the B logo are trademarks owned by or licensed to Nautilus, Inc.

### Important Safety Instructions - Before servicing or using this equipment, obey the following warnings:

 **This icon means a potentially hazardous situation which, if not avoided, could result in death or serious injury. Read and understand all Warnings on this machine.**

**⚠ DANGER** **To reduce the risk of electrical shock or unsupervised usage of the equipment, always unplug the power cord from the wall outlet and wait 5 minutes before cleaning, maintaining or repairing this machine. Place the power cord in a secure location.**

- Read and understand the Part Replacement Procedure before working on the machine. Failure to obey the instructions and safety warnings could cause injury to the service technician or bystanders.
- Keep bystanders, children and pets away from the product being serviced at all times.
- Make sure that the repair is done in an appropriate work space away from foot traffic and exposure to bystanders.
- Disconnect all power and allow to sit for 5 minutes before you service this machine.
- Some components of the equipment can be heavy or awkward. Enlist the service of a second person when you do maintenance steps involving these components. Do not try to do heavy or awkward steps on your own.
- If replacement parts are necessary, use only genuine Nautilus replacement parts and hardware. Failure to use genuine replacement parts can cause a risk to users, keep the machine from operating correctly and will void the warranty.
- Be sure that all warning stickers and instructional placards applied to the product stay present and in good condition when doing maintenance or replacing components. If necessary request replacement warning stickers or placards from Nautilus customer service.
- Do not try to change the design or functionality of the machine being serviced as this can adversely effect user safety and will void the warranty.
- Do not use the machine until all shrouds, instructions, warning labels and correct functionality have been verified and tested for correct performance.

### Tools Required (not included)

#2 Phillips screwdriver

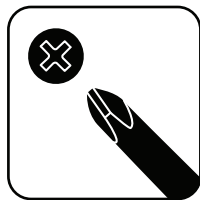

**⚠ DANGER** To reduce the risk of electrical shock or unsupervised usage of the equipment, always unplug the power cord from the wall outlet and wait 5 minutes before cleaning, maintaining or repairing this machine. Place the power cord in a secure location.

1. Unplug the power cord from the machine and wait 5 minutes. Place the power cord in a secure location.

2. Make sure that there is safe clearance around, on and above the treadmill. Make sure there is no object to spill or cause blockage from the fully folded position.

**⚠** Be sure there is adequate height clearance for the raised deck.

3. Using the support bar found below the rear of the walking belt, push the Deck Release Handle and lift the walking deck fully upward and engage the hydraulic lift. Be sure that the hydraulic lift is correctly locked in place. You will hear an audible click when the hydraulic lift shifts into the locked position.

**⚠** Use proper safety precautions and lifting techniques. Bend your knees and elbows, keep your back straight and pull up equally with both arms. Straighten your legs to lift. Make sure that your own physical strength is capable of lifting the walking deck until it engages the locking mechanism. Use a second person if necessary.

**Do not use the walking belt or rear roller to lift the treadmill. These parts do not lock in place and can abruptly move. Injury to you or damage to the machine can occur.**

4. Make sure that the locking mechanism is engaged. Carefully pull back on the walking deck and make sure that it does not move. When you do this, keep clear of movement path in case the treadmill lock is not properly engaged.

**⚠** Do not lean against the treadmill when it is folded. Do not put items on it that could cause it to become unstable or fall.



5. Using a #2 Phillips screwdriver, remove the two indicated screws from the Rear Roller Cover.

6. Remove the Rear Roller Cover noting how it attaches for re-assembly.



7. Re-install all parts that were removed in reverse order.

8. Make sure there is sufficient space to lower the walking deck.

**⚠ Keep a minimum clearance behind the machine of 79" (2 m) and 24" (0.6 m) on each side. This is the recommended safe distance for access, movement and emergency dismounts from the machine.**

9. Make sure there is no object on or around the treadmill to spill or cause blockage from the fully unfolded position.

10. Slightly push the walking deck forward toward the console, and then push the Deck Release Handle until the locking tube releases and you can pull the walking deck away from the console. Hold up the rear of the walking deck, and move to the side of the machine.

**⚠ Keep clear of the movement path of the walking deck.**

11. The hydraulic lift is set up to drop gradually. Hold onto the walking deck until approximately 2/3 of the movement down. Make sure that you use proper lifting technique; bend your knees and keep your back straight. Lower the weight with your legs. Be aware that the walking deck can possibly drop quickly in the last part of the movement.

12. Final Inspection

Inspect your machine to ensure that all hardware is tight and components are properly assembled.

**⚠ Do not use until the machine has been fully assembled and inspected for correct performance in accordance with the Owner's Manual.**

**NOTICE:** This document provides instructions for the replacement of the Right Upright on the Bowflex® BXT116 / BXT216 Treadmills.

**If you need assistance, please call Bowflex Customer Service at 1-800-605-3369.**

**This icon means a potentially hazardous situation which, if not avoided, could result in death or serious injury. Read and understand all Warnings on this machine.**

Nautilus, Inc., (800) NAUTILUS / (800) 628-8458, www.NautilusInc.com - Customer Service: North America (800) 605-3369, csnl@nautilus.com | outside U.S. www.nautilusinternational.com | Printed in China | © 2017 Nautilus, Inc. | ® indicates trademarks registered in the United States. These marks may be registered in other nations or otherwise protected by common law. Bowflex and the B logo are trademarks owned by or licensed to Nautilus, Inc.

### Important Safety Instructions - Before servicing or using this equipment, obey the following warnings:

**This icon means a potentially hazardous situation which, if not avoided, could result in death or serious injury. Read and understand all Warnings on this machine.**

**⚠ DANGER** **To reduce the risk of electrical shock or unsupervised usage of the equipment, always unplug the power cord from the wall outlet and wait 5 minutes before cleaning, maintaining or repairing this machine. Place the power cord in a secure location.**

- Read and understand the Part Replacement Procedure before working on the machine. Failure to obey the instructions and safety warnings could cause injury to the service technician or bystanders.
- Keep bystanders, children and pets away from the product being serviced at all times.
- Make sure that the repair is done in an appropriate work space away from foot traffic and exposure to bystanders.
- Disconnect all power and allow to sit for 5 minutes before you service this machine.
- Some components of the equipment can be heavy or awkward. Enlist the service of a second person when you do maintenance steps involving these components. Do not try to do heavy or awkward steps on your own.
- If replacement parts are necessary, use only genuine Nautilus replacement parts and hardware. Failure to use genuine replacement parts can cause a risk to users, keep the machine from operating correctly and will void the warranty.
- Be sure that all warning stickers and instructional placards applied to the product stay present and in good condition when doing maintenance or replacing components. If necessary request replacement warning stickers or placards from Nautilus customer service.
- Do not try to change the design or functionality of the machine being serviced as this can adversely effect user safety and will void the warranty.
- Do not use the machine until all shrouds, instructions, warning labels and correct functionality have been verified and tested for correct performance.

### Tools Required (not included)

#2 Phillips screwdriver



Standard screwdriver



6mm hex wrench



**⚠ DANGER**

To reduce the risk of electrical shock or unsupervised usage of the equipment, always unplug the power cord from the wall outlet and wait 5 minutes before cleaning, maintaining or repairing this machine. Place the power cord in a secure location.

**Note:** The Bowflex® BXT116 is used in the following images. The procedure is the same for the BXT216 model.

1. Unplug the power cord from the machine and wait 5 minutes. Place the power cord in a secure location.
2. Using a standard screwdriver, gently lift and release the Junction Cover End Caps from the Console Assembly.
3. Remove the Junction Cover End Caps from the Console Assembly.



4. Using a #2 Phillips screwdriver, remove the 4 indicated screws (by arrows) from Lower Junction Covers.
5. Gently release the snaps (indicated by ovals, two on each side) that secure the Upper and Lower Junction Covers and remove the Upper Junction Covers.

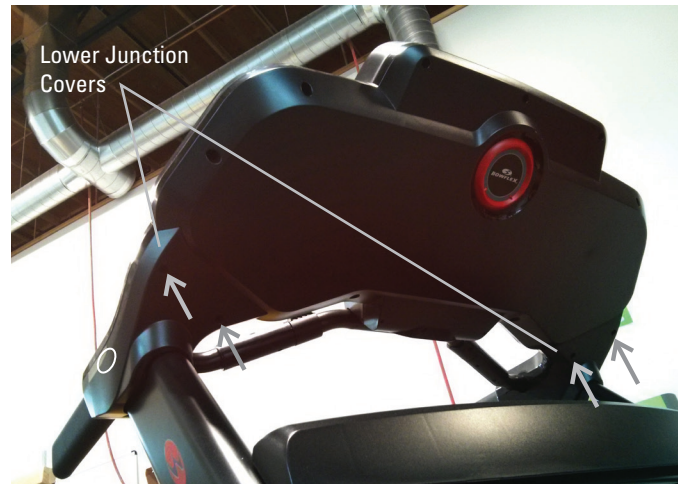

6. Gently pull out the Input/Output (I/O) and Grounding Cables from the Right Upright, and disconnect them. Do not allow the Cables to fall into the Right Upright. Secure them with A Zip-Tie, rubber band or piece of wire.

**Note:** Do not crimp the Cables.





7. Using a 6mm hex wrench, remove the 8 screws that secure the Console Assembly from the Right and Left Uprights.

**Note:** To assist with re-assembly, be sure to note that the curved washers are used facing the rear of the machine.

8. Fully remove the Console and Handlebar Assembly from the Uprights.



9. Remove the Lower Junction Covers from the Uprights.

10. Remove the Crossbar Tray from the Crossbar.

11. Remove the Right Base Shroud from the Base Assembly.



12. Using a 6mm hex wrench, remove the 4 screws from the Crossbar. Be prepared to support the Crossbar when the hardware is removed.



13. Using a 6mm hex wrench, remove the hardware from the Right Upright. Slightly remove the Right Upright from the Base Assembly exposing the Input/Output (I/O) and Grounding Cables. Disconnect the Cables and remove the Right Upright.

**Note:** Do not crimp cables.

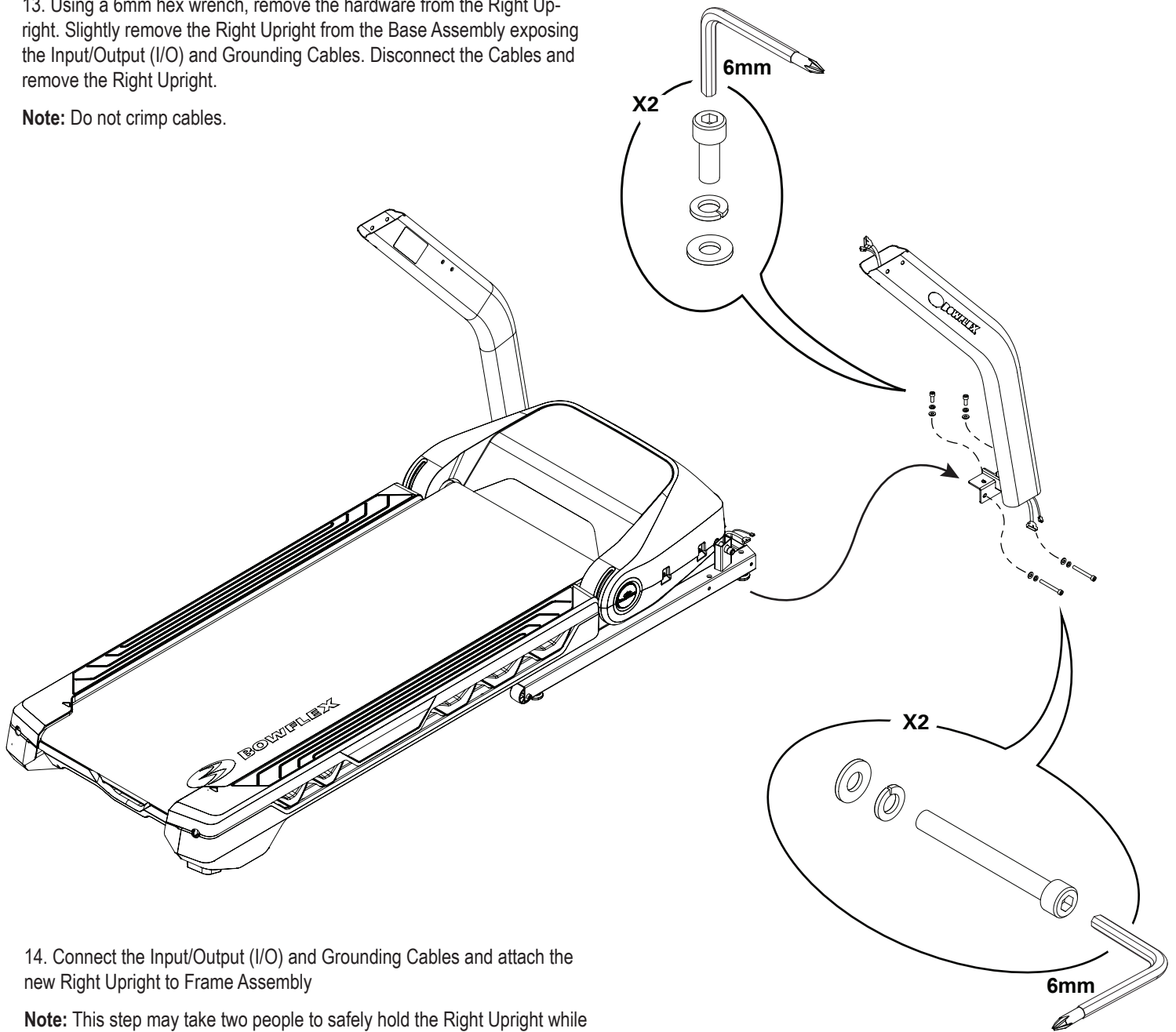

14. Connect the Input/Output (I/O) and Grounding Cables and attach the new Right Upright to Frame Assembly

**Note:** This step may take two people to safely hold the Right Upright while the Cables are connected. Do not crimp the Cables. Do not fully tighten the Hardware until the Console and Handlebar Assembly has been attached.

15. Re-install all remaining parts that were removed in reverse order.

16. Final Inspection

Inspect your machine to ensure that all hardware is tight and components are properly assembled.



**Do not use until the machine has been fully assembled and inspected for correct performance in accordance with the Owner's Manual.**

**NOTICE:** This document provides instructions for the replacement of the Rocker Switch on the Bowflex® BXT116 / BXT216 Treadmills.

**If you need assistance, please call Bowflex Customer Service at 1-800-605-3369.**

 **This icon means a potentially hazardous situation which, if not avoided, could result in death or serious injury. Read and understand all Warnings on this machine.**

Nautilus, Inc., www.NautilusInc.com - Customer Service: North America (800) 605-3369, csnl@nautilus.com | outside U.S. www.nautilusinternational.com | Printed in China | © 2017 Nautilus, Inc. | ® indicates trademarks registered in the United States. These marks may be registered in other nations or otherwise protected by common law. Bowflex and the B logo are trademarks owned by or licensed to Nautilus, Inc.

### Important Safety Instructions - Before servicing or using this equipment, obey the following warnings:

 **This icon means a potentially hazardous situation which, if not avoided, could result in death or serious injury. Read and understand all Warnings on this machine.**

**⚠ DANGER** To reduce the risk of electrical shock or unsupervised usage of the equipment, always unplug the power cord from the wall outlet and wait 5 minutes before cleaning, maintaining or repairing this machine. Place the power cord in a secure location.

- Read and understand the Part Replacement Procedure before working on the machine. Failure to obey the instructions and safety warnings could cause injury to the service technician or bystanders.
- Keep bystanders, children and pets away from the product being serviced at all times.
- Make sure that the repair is done in an appropriate work space away from foot traffic and exposure to bystanders.
- Disconnect all power and allow to sit for 5 minutes before you service this machine.
- Some components of the equipment can be heavy or awkward. Enlist the service of a second person when you do maintenance steps involving these components. Do not try to do heavy or awkward steps on your own.
- If replacement parts are necessary, use only genuine Nautilus replacement parts and hardware. Failure to use genuine replacement parts can cause a risk to users, keep the machine from operating correctly and will void the warranty.
- Be sure that all warning stickers and instructional placards applied to the product stay present and in good condition when doing maintenance or replacing components. If necessary request replacement warning stickers or placards from Nautilus customer service.
- Do not try to change the design or functionality of the machine being serviced as this can adversely effect user safety and will void the warranty.
- Do not use the machine until all shrouds, instructions, warning labels and correct functionality have been verified and tested for correct performance.

### Tools Required (not included)

#2 Phillips screwdriver (short)

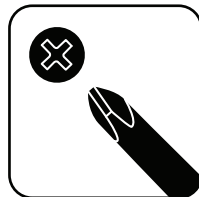

**Note:** The Bowflex® BXT116 is used in the following images. The procedure is the same for the BXT216 model.

1. With power supplied to the machine and it turned on, adjust the Walking Deck Incline to a setting of '6'. To adjust, push the '6' Pre-Set Incline button, and then the Confirm Incline button. Allow the Walking Deck to adjust to the new incline height.

2. Unplug the power cord from the machine and wait 5 minutes. Place the power cord in a secure location.

**⚠ DANGER** To reduce the risk of electrical shock or unsupervised usage of the equipment, always unplug the power cord from the wall outlet and wait 5 minutes before cleaning, maintaining or repairing this machine. Place the power cord in a secure location.

3. Using a #2 Phillips screwdriver, remove the screw (indicated by ovals) from each of the Base Shrouds.

4. Remove the Base Shrouds from the machine.

5. Using a #2 Phillips screwdriver, remove the 10 indicated screws that secure the Motor Cover.

**Note:** There are 2 screws that secure the Motor Cover from the underside of the machine (see image to the right).

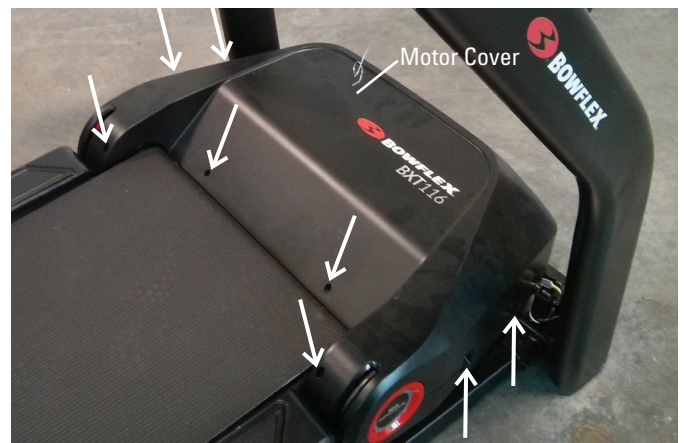

6. Gently release the front snaps (indicated by ovals) that secure the Motor Cover and pivot it back toward the walking belt until it releases. Remove from the machine.



7. Using a #2 Phillips screwdriver, remove the 2 indicated screws from the Motor Control Board Cover. Lift and remove the Motor Control Board Cover.

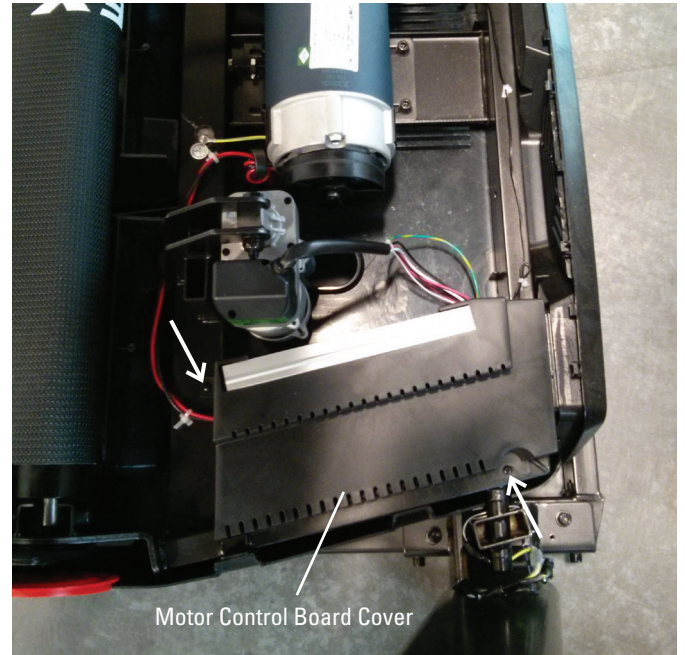

8. Release the Securing Clips from the Rocker Switch and remove it from the Frame.

9. Remove the connectors and attach them to the new Rocker Switch. Be sure to attach them in the same locations on the new Rocker Switch.

10. Insert the new Rocker Switch into the Frame, being sure the Securing Clips engage.

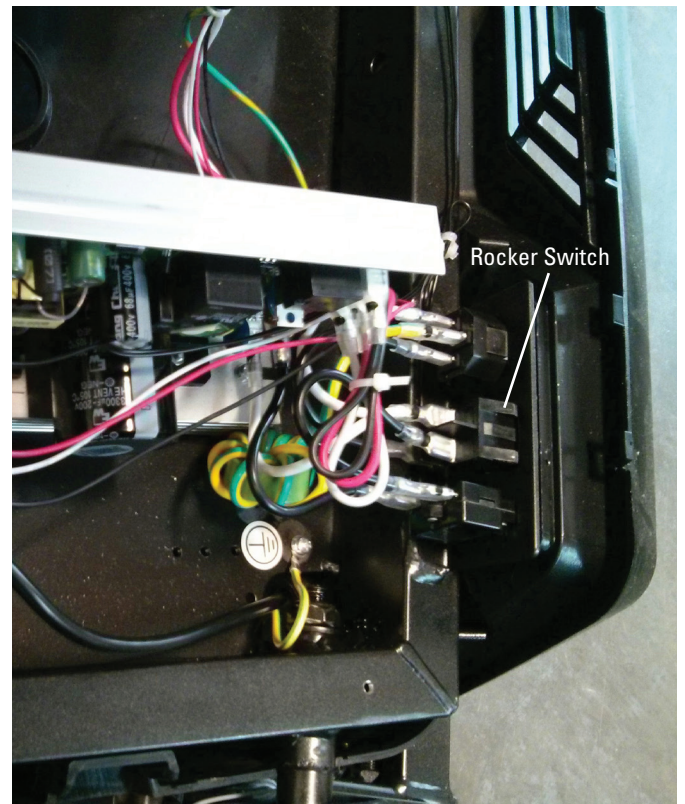

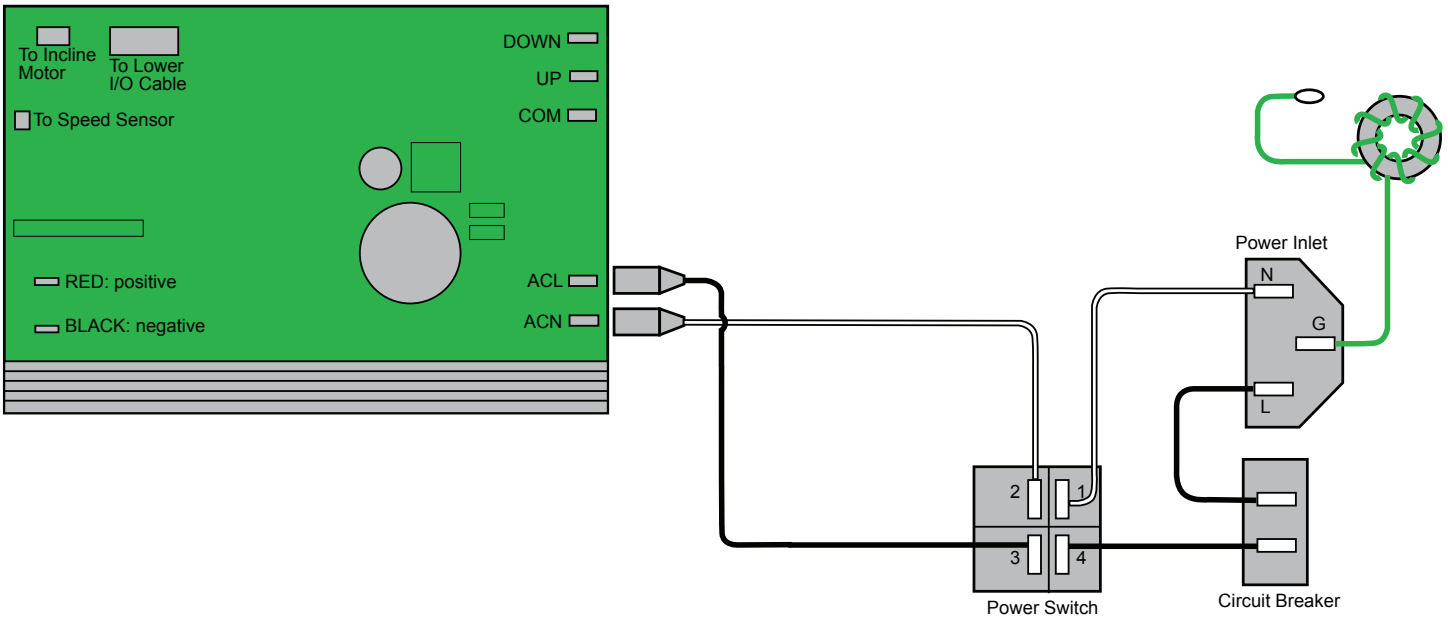
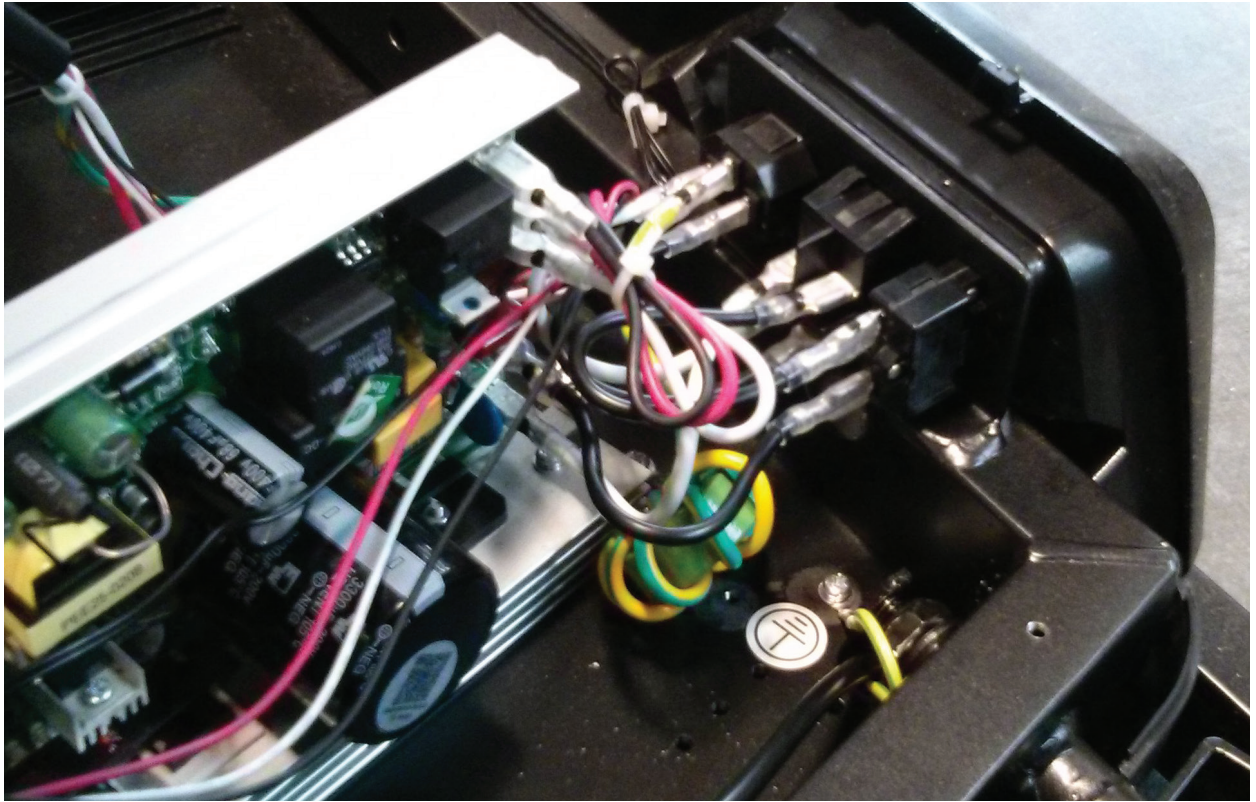

11. Re-install all remaining parts that were removed in reverse order.

12. Final Inspection

Inspect your machine to ensure that all hardware is tight and components are properly assembled.



**Do not use until the machine has been fully assembled and inspected for correct performance in accordance with the Owner's Manual.**

**NOTICE:** This document provides instructions to replace the Side Rail on the Bowflex® BXT116 Treadmill.

**If you need assistance, please call Bowflex Customer Service at 1-800-605-3369.**

 **This icon means a potentially hazardous situation which, if not avoided, could result in death or serious injury. Read and understand all Warnings on this machine.**

Nautilus, Inc., (800) NAUTILUS / (800) 628-8458, www.NautilusInc.com - Customer Service: North America (800) 605-3369, csnl@nautilus.com | outside U.S. www.nautilusinternational.com | Printed in China | © 2017 Nautilus, Inc. | ® indicates trademarks registered in the United States. These marks may be registered in other nations or otherwise protected by common law. Bowflex and the B logo are trademarks owned by or licensed to Nautilus, Inc.

### Important Safety Instructions - Before servicing or using this equipment, obey the following warnings:

 **This icon means a potentially hazardous situation which, if not avoided, could result in death or serious injury. Read and understand all Warnings on this machine.**

**⚠ DANGER** To reduce the risk of electrical shock or unsupervised usage of the equipment, always unplug the power cord from the wall outlet and wait 5 minutes before cleaning, maintaining or repairing this machine. Place the power cord in a secure location.

- Read and understand the Part Replacement Procedure before working on the machine. Failure to obey the instructions and safety warnings could cause injury to the service technician or bystanders.
- Keep bystanders, children and pets away from the product being serviced at all times.
- Make sure that the repair is done in an appropriate work space away from foot traffic and exposure to bystanders.
- Disconnect all power and allow to sit for 5 minutes before you service this machine.
- Some components of the equipment can be heavy or awkward. Enlist the service of a second person when you do maintenance steps involving these components. Do not try to do heavy or awkward steps on your own.
- If replacement parts are necessary, use only genuine Nautilus replacement parts and hardware. Failure to use genuine replacement parts can cause a risk to users, keep the machine from operating correctly and will void the warranty.
- Be sure that all warning stickers and instructional placards applied to the product stay present and in good condition when doing maintenance or replacing components. If necessary request replacement warning stickers or placards from Nautilus customer service.
- Do not try to change the design or functionality of the machine being serviced as this can adversely effect user safety and will void the warranty.
- Do not use the machine until all shrouds, instructions, warning labels and correct functionality have been verified and tested for correct performance.

### Tools Required (not included)

Short #2 Phillips screwdriver

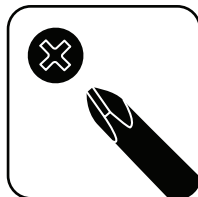

**⚠ DANGER** To reduce the risk of electrical shock or unsupervised usage of the equipment, always unplug the power cord from the wall outlet and wait 5 minutes before cleaning, maintaining or repairing this machine. Place the power cord in a secure location.

1. Unplug the power cord from the machine and wait 5 minutes. Place the power cord in a secure location.

2. Make sure that there is safe clearance around, on and above the treadmill. Make sure there is no object to spill or cause blockage from the fully folded position.

**⚠** Be sure there is adequate height clearance for the raised deck.

3. Using the support bar found below the rear of the walking belt, push the Deck Release Handle and lift the walking deck fully upward and engage the hydraulic lift. Be sure that the hydraulic lift is correctly locked in place. You will hear an audible click when the hydraulic lift shifts into the locked position.

**⚠** Use proper safety precautions and lifting techniques. Bend your knees and elbows, keep your back straight and pull up equally with both arms. Straighten your legs to lift. Make sure that your own physical strength is capable of lifting the walking deck until it engages the locking mechanism. Use a second person if necessary.

**Do not use the walking belt or rear roller to lift the treadmill. These parts do not lock in place and can abruptly move. Injury to you or damage to the machine can occur.**

4. Make sure that the locking mechanism is engaged. Carefully pull back on the walking deck and make sure that it does not move. When you do this, keep clear of movement path in case the treadmill lock is not properly engaged.

**⚠** Do not lean against the treadmill when it is folded. Do not put items on it that could cause it to become unstable or fall.

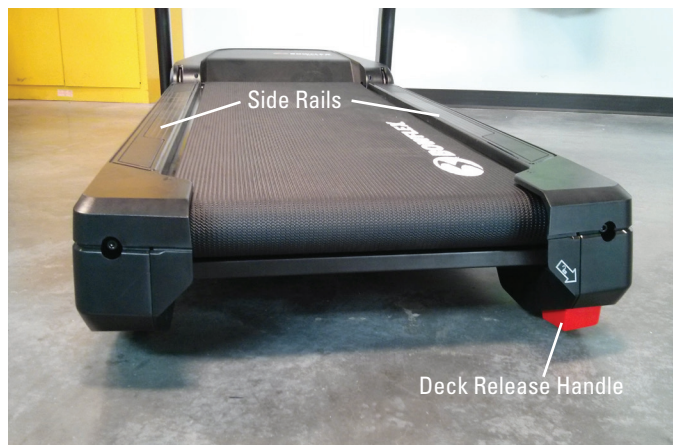



5. Using a #2 Phillips screwdriver, remove the two indicated screws from the Rear Roller Cover.

6. Remove the Rear Roller Cover noting how it attaches for re-assembly.



7. Using a #2 Phillips screwdriver, remove the 4 indicated screws that secure the Side Rail. Remove it from the machine.



8. Re-install all parts that were removed in reverse order.

9. Make sure there is sufficient space to lower the walking deck.

 **Keep a minimum clearance behind the machine of 79" (2 m) and 24" (0.6 m) on each side. This is the recommended safe distance for access, movement and emergency dismounts from the machine.**

10. Make sure there is no object on or around the treadmill to spill or cause blockage from the fully unfolded position.

11. Slightly push the walking deck forward toward the console, and then push the Deck Release Handle until the locking tube releases and you can pull the walking deck away from the console. Hold up the rear of the walking deck, and move to the side of the machine.

 **Keep clear of the movement path of the walking deck.**

12. The hydraulic lift is set up to drop gradually. Hold onto the walking deck until approximately 2/3 of the movement down. Make sure that you use proper lifting technique; bend your knees and keep your back straight. Lower the weight with your legs. Be aware that the walking deck can possibly drop quickly in the last part of the movement.

13. Final Inspection

Inspect your machine to ensure that all hardware is tight and components are properly assembled.

 **Do not use until the machine has been fully assembled and inspected for correct performance in accordance with the Owner's Manual.**

**NOTICE:** This document provides instructions for the replacement of the Speed Sensor Assembly on the Bowflex® BXT116 / BXT216 Treadmills.

**If you need assistance, please call Bowflex Customer Service at 1-800-605-3369.**

 **This icon means a potentially hazardous situation which, if not avoided, could result in death or serious injury. Read and understand all Warnings on this machine.**

Nautilus, Inc., www.NautilusInc.com - Customer Service: North America (800) 605-3369, csnl@nautilus.com | outside U.S. www.nautilusinternational.com | Printed in China | © 2017 Nautilus, Inc. | ® indicates trademarks registered in the United States. These marks may be registered in other nations or otherwise protected by common law. Bowflex and the B logo are trademarks owned by or licensed to Nautilus, Inc.

### Important Safety Instructions - Before servicing or using this equipment, obey the following warnings:

 **This icon means a potentially hazardous situation which, if not avoided, could result in death or serious injury. Read and understand all Warnings on this machine.**

**DANGER** **To reduce the risk of electrical shock or unsupervised usage of the equipment, always unplug the power cord from the wall outlet and wait 5 minutes before cleaning, maintaining or repairing this machine. Place the power cord in a secure location.**

- Read and understand the Part Replacement Procedure before working on the machine. Failure to obey the instructions and safety warnings could cause injury to the service technician or bystanders.
- Keep bystanders, children and pets away from the product being serviced at all times.
- Make sure that the repair is done in an appropriate work space away from foot traffic and exposure to bystanders.
- Disconnect all power and allow to sit for 5 minutes before you service this machine.
- Some components of the equipment can be heavy or awkward. Enlist the service of a second person when you do maintenance steps involving these components. Do not try to do heavy or awkward steps on your own.
- If replacement parts are necessary, use only genuine Nautilus replacement parts and hardware. Failure to use genuine replacement parts can cause a risk to users, keep the machine from operating correctly and will void the warranty.
- Be sure that all warning stickers and instructional placards applied to the product stay present and in good condition when doing maintenance or replacing components. If necessary request replacement warning stickers or placards from Nautilus customer service.
- Do not try to change the design or functionality of the machine being serviced as this can adversely effect user safety and will void the warranty.
- Do not use the machine until all shrouds, instructions, warning labels and correct functionality have been verified and tested for correct performance.

#### Tools Required (not included)

#2 Phillips screwdriver (short)

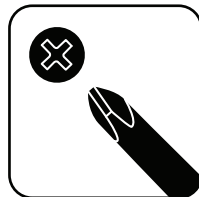

Something to cut Zip-Ties

Replacement Zip-Ties - 8" minimum ( x5 )



**Note:** The Bowflex® BXT116 is used in the following images. The procedure is the same for the BXT216 model.

1. With power supplied to the machine and it turned on, adjust the Walking Deck Incline to a setting of '6'. To adjust, push the '6' Pre-Set Incline button, and then the Confirm Incline button. Allow the Walking Deck to adjust to the new incline height.

2. Unplug the power cord from the machine and wait 5 minutes. Place the power cord in a secure location.

**⚠ DANGER** To reduce the risk of electrical shock or unsupervised usage of the equipment, always unplug the power cord from the wall outlet and wait 5 minutes before cleaning, maintaining or repairing this machine. Place the power cord in a secure location.

3. Using a #2 Phillips screwdriver, remove the screw (indicated by ovals) from each of the Base Shrouds.

4. Remove the Base Shrouds from the machine.

5. Using a #2 Phillips screwdriver, remove the 10 indicated screws that secure the Motor Cover.

**Note:** There are 2 screws that secure the Motor Cover from the underside of the machine (see image to the right).

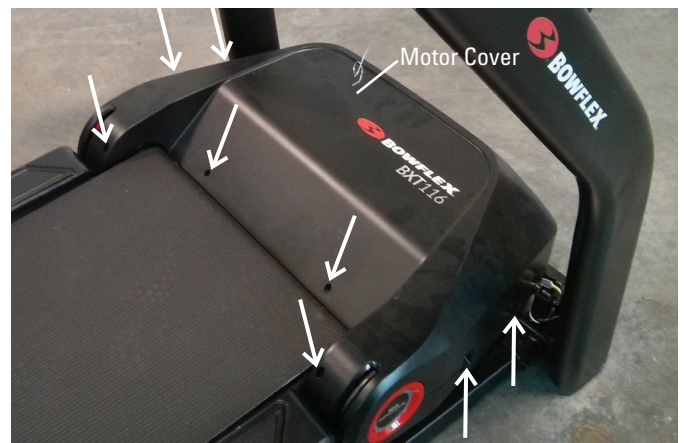

6. Gently release the front snaps (indicated by ovals) that secure the Motor Cover and pivot it back toward the walking belt until it releases. Remove from the machine.



7. Using a #2 Phillips screwdriver, remove the 2 indicated screws that attach the Speed Sensor to the Frame near the Drive Pulley.



**Note:** Motor and Drive Belt removed from the above image for clarity.

8. Cut the 5 Zip-Ties that secure the Speed Sensor Cable.

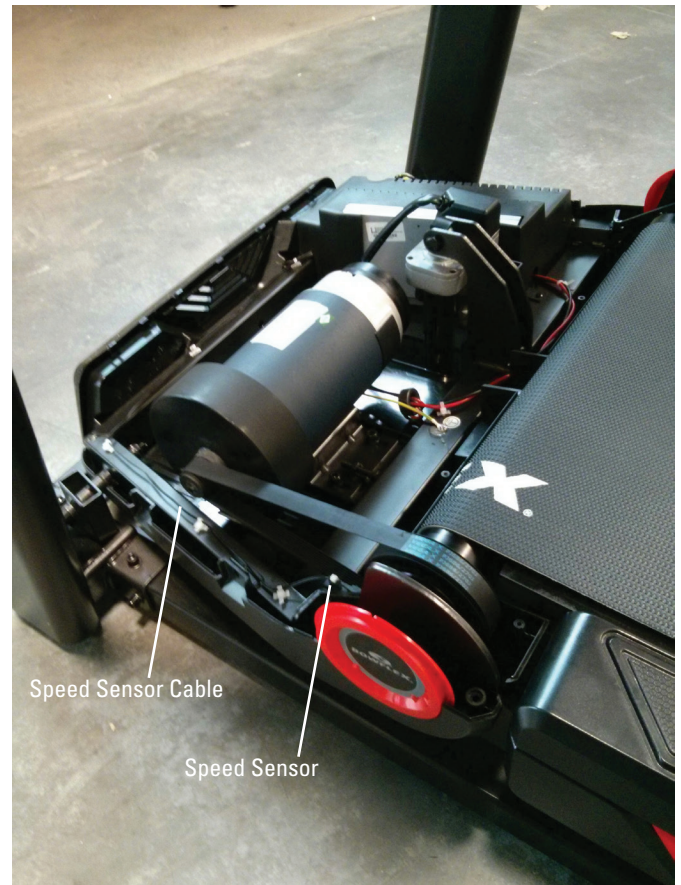

9. Using a #2 Phillips screwdriver, remove the 2 indicated screws from the Motor Control Board Cover. Lift and remove the Motor Control Board Cover.

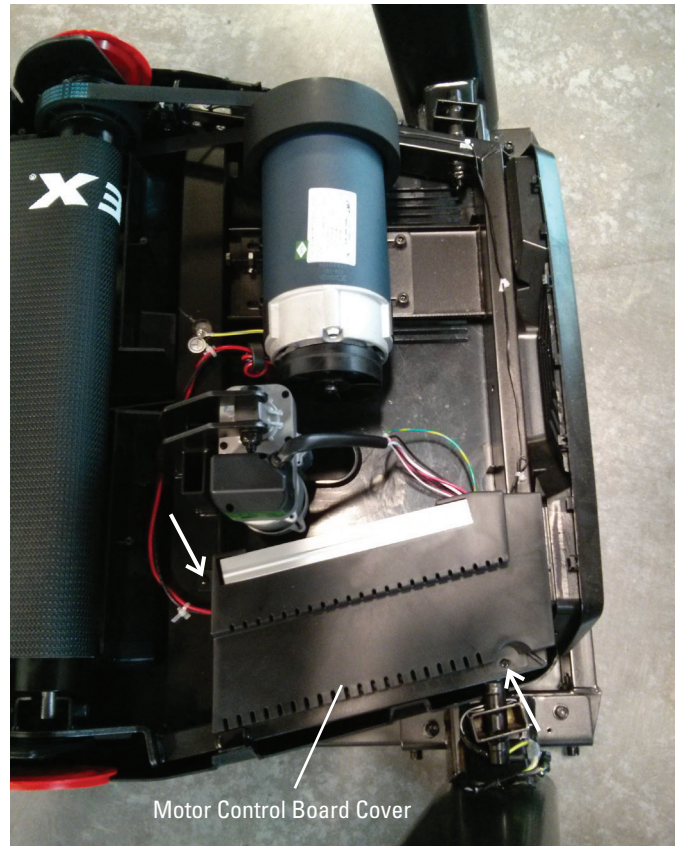

10. Remove the Speed Sensor Connector from the Motor Control Board.

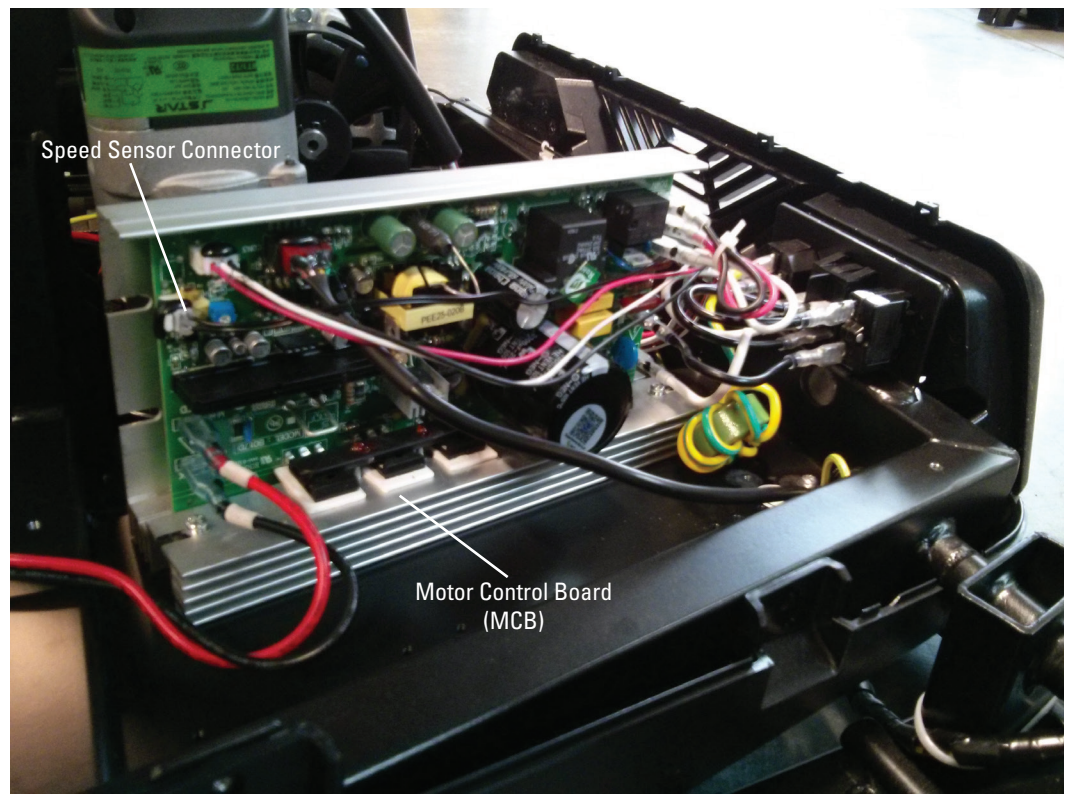

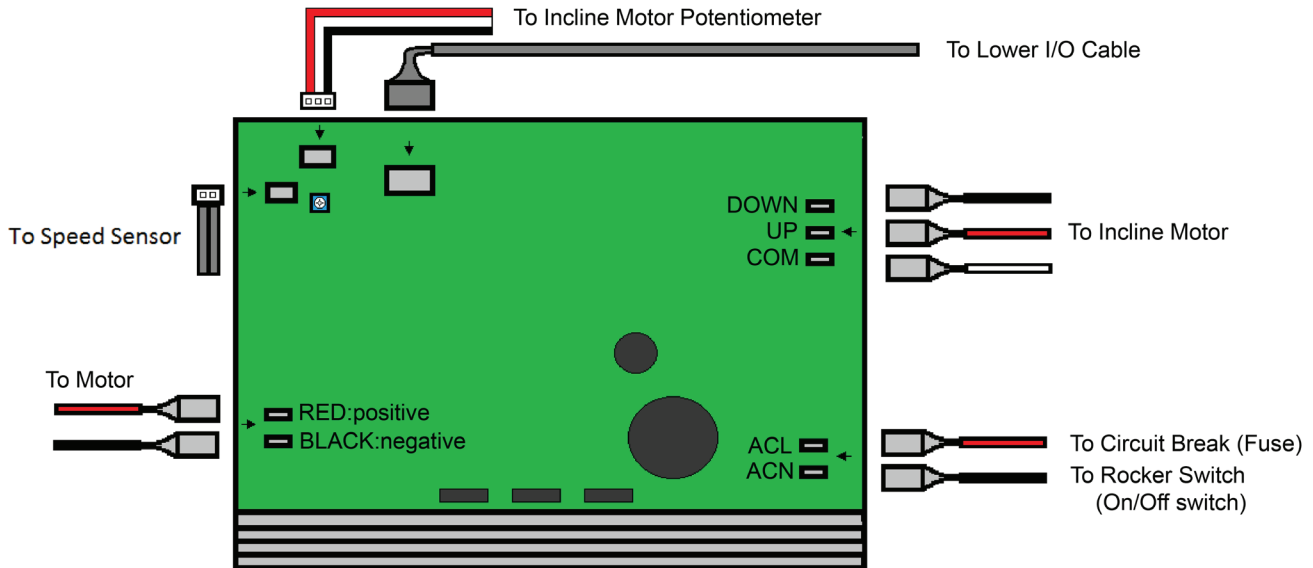

11. Attach the new Speed Sensor Connector to the Motor Control Board.
12. Route the new Speed Sensor Cable along the Frame.
13. Using replacement Zip-Ties, secure the Speed Sensor Cable to the Frame and trim the excess from the Zip-Ties. Be sure not to cut the Speed Sensor Cable.
14. Using a #2 Phillips screwdriver, attach the new Speed Sensor
15. Re-install all remaining parts that were removed in reverse order.
16. Final Inspection  
Inspect your machine to ensure that all hardware is tight and components are properly assembled.



**Do not use until the machine has been fully assembled and inspected for correct performance in accordance with the Owner's Manual.**

**NOTICE:** This document provides instructions for the replacement of the Transport Wheel on the Bowflex® BXT116 / BXT216 Treadmills.

**If you need assistance, please call Bowflex Customer Service at 1-800-605-3369.**

 **This icon means a potentially hazardous situation which, if not avoided, could result in death or serious injury. Read and understand all Warnings on this machine.**

Nautilus, Inc., www.NautilusInc.com - Customer Service: North America (800) 605-3369, csnl@nautilus.com | outside U.S. www.nautilusinternational.com | Printed in China | © 2017 Nautilus, Inc. | ® indicates trademarks registered in the United States. These marks may be registered in other nations or otherwise protected by common law. Bowflex and the B logo are trademarks owned by or licensed to Nautilus, Inc.

### Important Safety Instructions - Before servicing or using this equipment, obey the following warnings:

 **This icon means a potentially hazardous situation which, if not avoided, could result in death or serious injury. Read and understand all Warnings on this machine.**

**⚠ DANGER** **To reduce the risk of electrical shock or unsupervised usage of the equipment, always unplug the power cord from the wall outlet and wait 5 minutes before cleaning, maintaining or repairing this machine. Place the power cord in a secure location.**

- Read and understand the Part Replacement Procedure before working on the machine. Failure to obey the instructions and safety warnings could cause injury to the service technician or bystanders.
- Keep bystanders, children and pets away from the product being serviced at all times.
- Make sure that the repair is done in an appropriate work space away from foot traffic and exposure to bystanders.
- Disconnect all power and allow to sit for 5 minutes before you service this machine.
- Some components of the equipment can be heavy or awkward. Enlist the service of a second person when you do maintenance steps involving these components. Do not try to do heavy or awkward steps on your own.
- If replacement parts are necessary, use only genuine Nautilus replacement parts and hardware. Failure to use genuine replacement parts can cause a risk to users, keep the machine from operating correctly and will void the warranty.
- Be sure that all warning stickers and instructional placards applied to the product stay present and in good condition when doing maintenance or replacing components. If necessary request replacement warning stickers or placards from Nautilus customer service.
- Do not try to change the design or functionality of the machine being serviced as this can adversely effect user safety and will void the warranty.
- Do not use the machine until all shrouds, instructions, warning labels and correct functionality have been verified and tested for correct performance.

### Tools Required (not included)

6mm hex wrench



13mm wrench

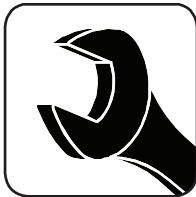



**⚠ DANGER** To reduce the risk of electrical shock or unsupervised usage of the equipment, always unplug the power cord from the wall outlet and wait 5 minutes before cleaning, maintaining or repairing this machine. Place the power cord in a secure location.

**Note:** The Bowflex® BXT116 is used in the following images. The procedure is the same for the BXT216 model.

1. Unplug the power cord from the machine and wait 5 minutes. Place the power cord in a secure location.

2. Make sure that there is safe clearance around, on and above the treadmill. Make sure there is no object to spill or cause blockage from the fully folded position.

**⚠** Be sure there is adequate height clearance for the raised deck.

3. Using the support bar found below the rear of the walking belt, push the Deck Release Handle and lift the walking deck fully upward and engage the hydraulic lift. Be sure that the hydraulic lift is correctly locked in place. You will hear an audible click when the hydraulic lift shifts into the locked position.

**⚠** Use proper safety precautions and lifting techniques. Bend your knees and elbows, keep your back straight and pull up equally with both arms. Straighten your legs to lift. Make sure that your own physical strength is capable of lifting the walking deck until it engages the locking mechanism. Use a second person if necessary.

Do not use the walking belt or rear roller to lift the treadmill. These parts do not lock in place and can abruptly move. Injury to you or damage to the machine can occur.

4. Make sure that the locking mechanism is engaged. Carefully pull back on the walking deck and make sure that it does not move. When you do this, keep clear of movement path in case the treadmill lock is not properly engaged.

**⚠** Do not lean against the treadmill when it is folded. Do not put items on it that could cause it to become unstable or fall.



5. Using a 13mm wrench and a 6mm hex wrench, remove the indicated hardware from the Transport Wheel.

6. Using a 13mm wrench and a 6mm hex wrench, attach the new Transport Wheel to the Frame Assembly.

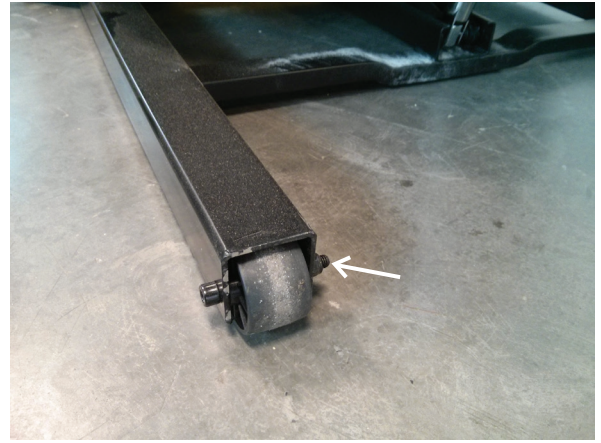

7. Make sure there is sufficient space to lower the walking deck.

**⚠ Keep a minimum clearance behind the machine of 79" (2 m) and 24" (0.6 m) on each side. This is the recommended safe distance for access, movement and emergency dismounts from the machine.**

8. Make sure there is no object on or around the treadmill to spill or cause blockage from the fully unfolded position.

9. Slightly push the walking deck forward toward the console. Push the Deck Release Handle until the lift shock releases and you can pull the walking deck away from the console. Hold up the rear of the walking deck, and move to the side of the machine.

**⚠ Keep clear of the movement path of the walking deck.**

10. The hydraulic lift is set up to drop gradually. Hold onto the walking deck until approximately 2/3 of the movement down. Make sure that you use proper lifting technique; bend your knees and keep your back straight. Lower the weight with your legs. Be aware that the walking deck can possibly drop quickly in the last part of the movement.

11. Final Inspection  
Inspect your machine to ensure that all hardware is tight and components are properly assembled.

**⚠ Do not use until the machine has been fully assembled and inspected for correct performance in accordance with the Owner's Manual.**



**NOTICE:** This document provides instructions for the replacement of the Walking Belt on the Bowflex® BXT116 Treadmill.

**If you need assistance, please call Bowflex Customer Service at 1-800-605-3369.**

 **This icon means a potentially hazardous situation which, if not avoided, could result in death or serious injury. Read and understand all Warnings on this machine.**

Nautilus, Inc., www.NautilusInc.com - Customer Service: North America (800) 605-3369, csnl@s@nautilus.com | outside U.S. www.nautilusinternational.com | Printed in China | © 2017 Nautilus, Inc. | ® indicates trademarks registered in the United States. These marks may be registered in other nations or otherwise protected by common law. Bowflex and the B logo are trademarks owned by or licensed to Nautilus, Inc.

### Important Safety Instructions - Before servicing or using this equipment, obey the following warnings:

 **This icon means a potentially hazardous situation which, if not avoided, could result in death or serious injury. Read and understand all Warnings on this machine.**

**⚠ DANGER** **To reduce the risk of electrical shock or unsupervised usage of the equipment, always unplug the power cord from the wall outlet and wait 5 minutes before cleaning, maintaining or repairing this machine. Place the power cord in a secure location.**

- Read and understand the Part Replacement Procedure before working on the machine. Failure to obey the instructions and safety warnings could cause injury to the service technician or bystanders.
- Keep bystanders, children and pets away from the product being serviced at all times.
- Make sure that the repair is done in an appropriate work space away from foot traffic and exposure to bystanders.
- Disconnect all power and allow to sit for 5 minutes before you service this machine.
- Some components of the equipment can be heavy or awkward. Enlist the service of a second person when you do maintenance steps involving these components. Do not try to do heavy or awkward steps on your own.
- If replacement parts are necessary, use only genuine Nautilus replacement parts and hardware. Failure to use genuine replacement parts can cause a risk to users, keep the machine from operating correctly and will void the warranty.
- Be sure that all warning stickers and instructional placards applied to the product stay present and in good condition when doing maintenance or replacing components. If necessary request replacement warning stickers or placards from Nautilus customer service.
- Do not try to change the design or functionality of the machine being serviced as this can adversely effect user safety and will void the warranty.
- Do not use the machine until all shrouds, instructions, warning labels and correct functionality have been verified and tested for correct performance.

### Tools Required (not included)

#2 Phillips screwdriver

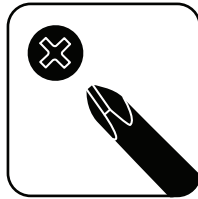

8300 Silicone Spray or Lube-N-Walk® Treadmill Lubrication Kit

6mm Hex Wrench



1. With power supplied to the machine and it turned on, adjust the Walking Deck Incline to a setting of '6'. To adjust, push the '6' Pre-Set Incline button, and then the Confirm Incline button. Allow the Walking Deck to adjust to the new incline height.

2. Unplug the power cord from the machine and wait 5 minutes. Place the power cord in a secure location.

**⚠ DANGER** To reduce the risk of electrical shock or unsupervised usage of the equipment, always unplug the power cord from the wall outlet and wait 5 minutes before cleaning, maintaining or repairing this machine. Place the power cord in a secure location.

3. Using a #2 Phillips screwdriver, remove the screw (indicated by ovals) from each of the Base Shrouds.

4. Remove the Base Shrouds from the machine.

5. Using a #2 Phillips screwdriver, remove the 10 indicated screws that secure the Motor Cover.

**Note:** There are 2 screws that secure the Motor Cover from the underside of the machine (see image to the right).



6. Gently release the front snaps (indicated by ovals) that secure the Motor Cover and pivot it back toward the walking belt until it releases. Remove from the machine.



7. Make sure that there is safe clearance around, on and above the treadmill. Make sure there is no object to spill or cause blockage from the fully folded position.

**!** Be sure there is adequate height clearance for the raised deck.

8. Using the support bar found below the rear of the walking belt, push the Deck Release Handle and lift the walking deck fully upward and engage the hydraulic lift. Be sure that the hydraulic lift is correctly locked in place. You will hear an audible click when the hydraulic lift shifts into the locked position.

**!** Use proper safety precautions and lifting techniques. Bend your knees and elbows, keep your back straight and pull up equally with both arms. Straighten your legs to lift. Make sure that your own physical strength is capable of lifting the walking deck until it engages the locking mechanism. Use a second person if necessary.

**Do not use the walking belt or rear roller to lift the treadmill. These parts do not lock in place and can abruptly move. Injury to you or damage to the machine can occur.**

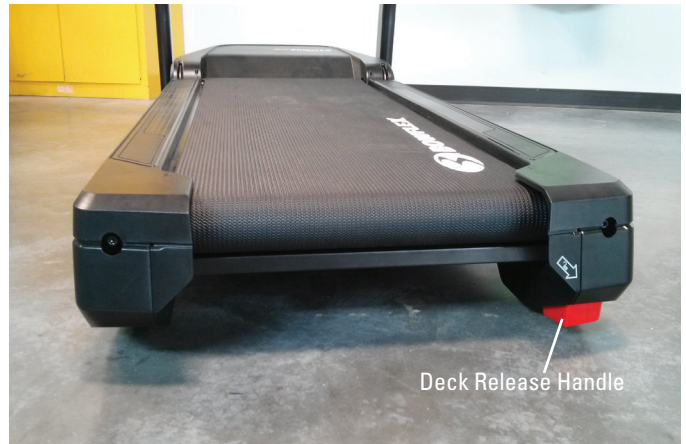

9. Make sure that the locking mechanism is engaged. Carefully pull back on the walking deck and make sure that it does not move. When you do this, keep clear of movement path in case the treadmill lock is not properly engaged.

**!** Do not lean against the treadmill when it is folded. Do not put items on it that could cause it to become unstable or fall.



10. Using a #2 Phillips screwdriver, remove the two indicated screws from the Rear Roller Cover.

11. Remove the Rear Roller Cover noting how it attaches for re-assembly.



12. Using a #2 Phillips screwdriver, remove the 4 indicated screws that secure the Side Rail. Remove it from the machine.



13. Using a #2 Phillips screwdriver, remove the 4 indicated screws from the Lower Side Rail.

14. Remove the Lower Side Rail noting how it attaches for re-assembly.



15. Using a #2 Phillips screwdriver, remove the 5 indicated screws from the Deck Suspension Inserts.

16. Make sure there is sufficient space to lower the walking deck.

**⚠ Keep a minimum clearance behind the machine of 79" (2 m) and 24" (0.6 m) on each side. This is the recommended safe distance for access, movement and emergency dismounts from the machine.**

17. Make sure there is no object on or around the treadmill to spill or cause blockage from the fully unfolded position.

18. Slightly push the walking deck forward toward the console, and then push the Deck Release Handle until the locking tube releases and you can pull the walking deck away from the console. Hold up the rear of the walking deck, and move to the side of the machine.

**⚠ Keep clear of the movement path of the walking deck.**

19. The hydraulic lift is set up to drop gradually. Hold onto the walking deck until approximately 2/3 of the movement down. Make sure that you use proper lifting technique; bend your knees and keep your back straight. Lower the weight with your legs. Be aware that the walking deck can possibly drop quickly in the last part of the movement.

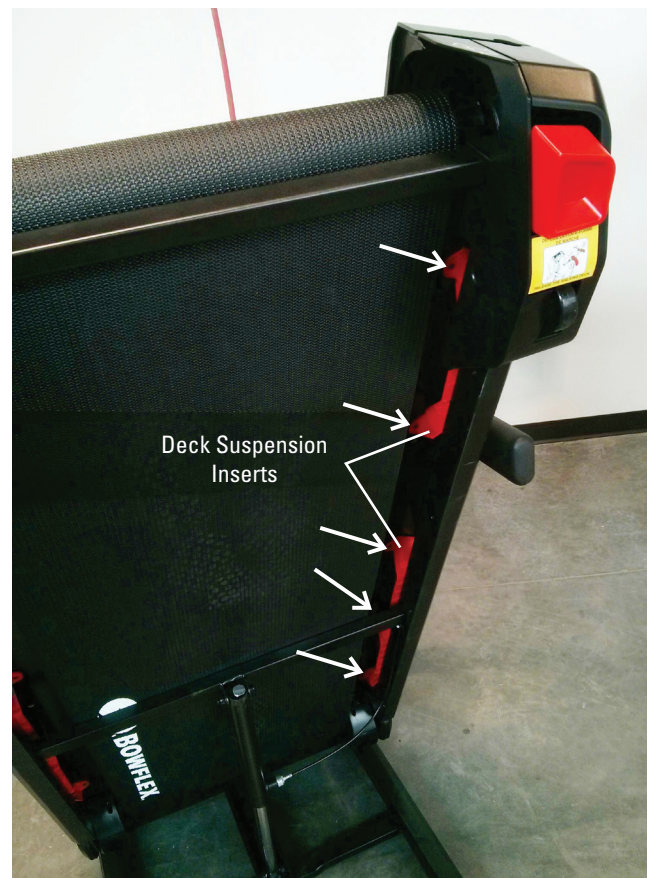

20. Using a 6mm hex wrench, remove the indicated Adjustment Bolts (with arrows) from the Rear Roller.

**Note:** Be sure to record the number of turns of the Adjustment Bolt it takes to remove it. This will assist with reassembly.

21. Slide the Rear Roller out of the Walking Belt.



22. Using a 6mm hex wrench, remove the 3 indicated screws from the Walking Deck.





23. Using a 6mm hex wrench, loosen the indicated screws (by arrow) on the Motor Mount.

24. Using a 13mm Open Ended Wrench, rotate the Belt Tensioner Screw enough to loosen the Drive Belt.

**Note:** To assist with reassembly, be sure to record the number of threads exposed before loosening.

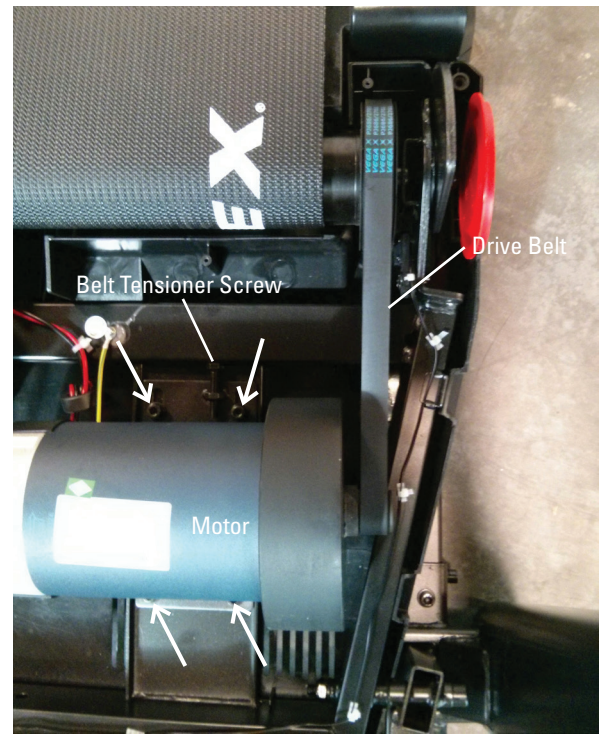

25. Using a 6mm hex wrench, remove the indicated screw from the Front Roller.

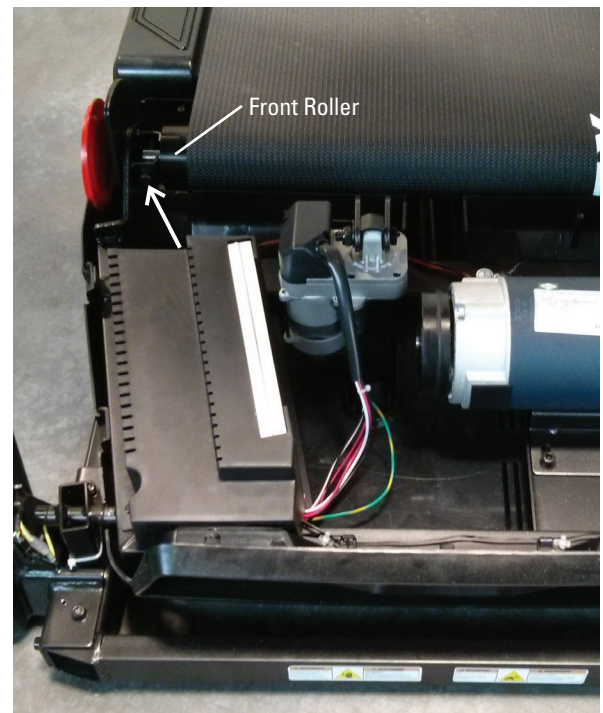

26. From the right side of the machine, grasp onto the Drive Pulley and pull it along with the Front Roller toward you. The Front Roller will “pop” out of the channel.

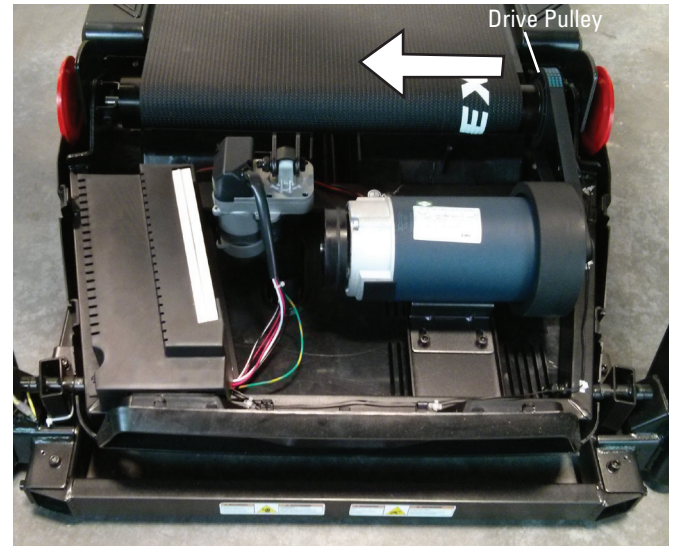

27. Lift and pivot the Front Roller out of the Frame, and slide it out of the Walking Belt. This will free the Drive Belt from the Front Roller.

28. Slide the Rear Roller out of the Walking Belt.

29. Slide the old Walking Belt off of the Deck, and replace with the new Walking Belt.

30. Slide the Rear Roller into the new Walking Belt.

31. Using a 6mm hex wrench, re-attach the Adjustment Bolts to the Rear Roller.

**Note:** Be sure to tighten the Adjustment Bolt the same number of turns it took to loosen the Walking Belt.

32. Using a 6mm hex wrench, re-install the 3 screws to the Deck.

33. Slide the Front Roller into the new Walking Belt in the same orientation.

34. Loop the Drive Belt around the Front Roller. Insert the end of the Front Roller with the Drive Pulley into the Frame and pivot the other end into the Bracket.

35. Using a 6mm hex wrench, attach the Front Roller to the Bracket.

**Note:** Tighten the hardware until the Front Roller is centered in the Bracket.

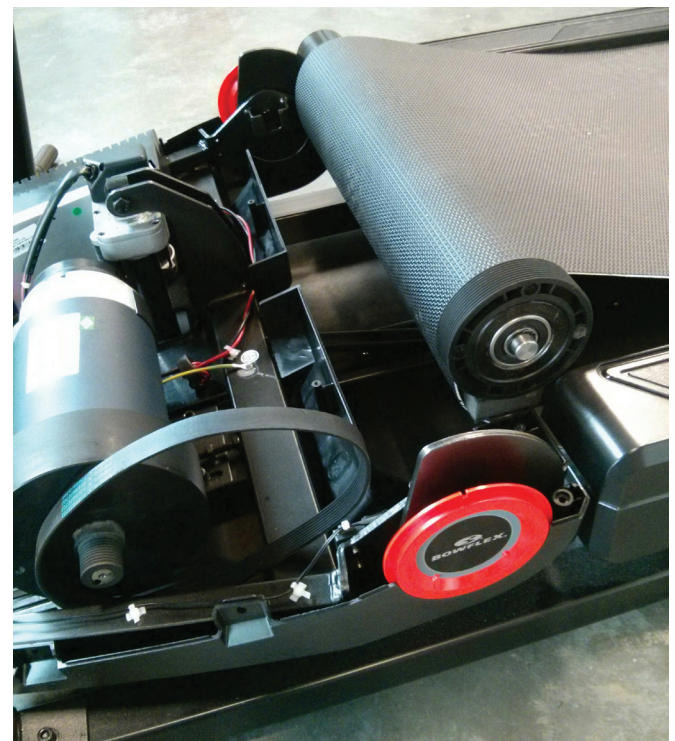

36. Loop the Drive Belt around the Motor Pulley. Start the Drive Belt on the Drive Pulley and roll it in a clockwise motion. Be sure the Belt does not come off of the Motor Pulley.

 **Keep fingers out of any pinch opportunities when turning the Pulleys.**

37. Roll the Drive Pulley clockwise until the Drive Belt is fully installed. Continue to roll the Belt forward while adding side pressure with fingers to align as necessary.

38. With the Motor Assembly loosely attached to the Frame, turn the Belt Tensioner Screw to the previous level. This will tighten the Drive Belt to the previous tension level.

39. Using a 6mm hex wrench, fully tighten the screws that attach the Motor Mount to the Frame.

40. Re-install all remaining parts that were removed in reverse order.

**Note:** Make sure the treadmill is located on a surface that is easy to clean.

41. Apply a few drops of the lubricant on the deck below the belt. Carefully lift the belt and apply a few drops of the lubricant the entire width of the belt. A very thin layer of silicone lubricant on the entire deck below the belt is desired.

**NOTICE:** Always use a 100% pure silicone lubricant. Do not use a degreaser like WD-40® as this could seriously impact performance. We can recommend that you use the following:

- 100% pure silicone, available at most hardware and auto parts stores.
- Lube-N-Walk® Treadmill Lubrication Kit, available from your local specialty fitness dealer or Nautilus, Inc.

 **Silicone lubricant is not intended for human consumption. Keep out of reach of children. Store in a safe place.**

42. Manually rotate the belt 1/2 of the length of the belt and apply lubricant again.

 **If you used spray lubricant, wait 5 minutes before turning on power to the machine to allow the aerosol to dissipate.**

43. Connect the power cord back into the machine and then into the wall outlet.

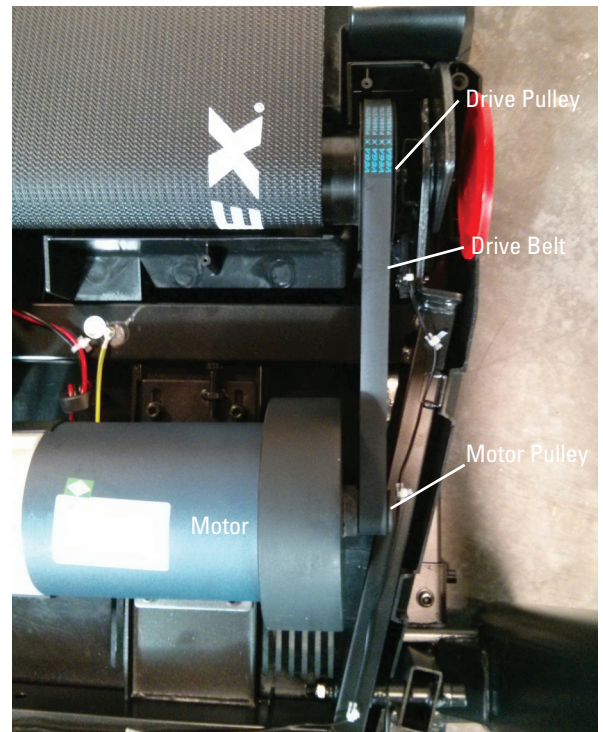

44. Turn on the power to the machine with the power switch.

45. Stay to one side of your machine and start the belt at the slowest speed. Let the belt operate for approximately 15 seconds.

 **Be sure not to touch the walking belt or step on the power cord. Keep bystanders and children away from the product you are servicing at all times.**

46. Switch off your machine.

47. Take care to clean up any excess lubricant from the deck.

 **To decrease the possibility of slipping, be sure the deck area is free from grease or oil. Clean off any excess oil from the machine surfaces.**

48. Final Inspection

Inspect your machine to ensure that all hardware is tight and components are properly assembled.

 **Do not use until the machine has been fully assembled and inspected for correct performance in accordance with the Owner's Manual.**

**NOTICE:** This document provides instructions for the service or replacement of the Motor Cover on the Bowflex® BXT116 Treadmill. The Walking Deck is designed for wear on both sides of it. If only one side of the Walking Deck is worn, a replacement Deck is not required.

If you need assistance, please call Bowflex Customer Service at 1-800-605-3369.

 This icon means a potentially hazardous situation which, if not avoided, could result in death or serious injury. Read and understand all Warnings on this machine.

Nautilus, Inc., www.NautilusInc.com - Customer Service: North America (800) 605-3369, csnl@s@nautilus.com | outside U.S. www.nautilusinternational.com | Printed in China | © 2017 Nautilus, Inc. | ® indicates trademarks registered in the United States. These marks may be registered in other nations or otherwise protected by common law. Bowflex and the B logo are trademarks owned by or licensed to Nautilus, Inc.

### Important Safety Instructions - Before servicing or using this equipment, obey the following warnings:

 This icon means a potentially hazardous situation which, if not avoided, could result in death or serious injury. Read and understand all Warnings on this machine.

**⚠ DANGER** To reduce the risk of electrical shock or unsupervised usage of the equipment, always unplug the power cord from the wall outlet and wait 5 minutes before cleaning, maintaining or repairing this machine. Place the power cord in a secure location.

- Read and understand the Part Replacement Procedure before working on the machine. Failure to obey the instructions and safety warnings could cause injury to the service technician or bystanders.
- Keep bystanders, children and pets away from the product being serviced at all times.
- Make sure that the repair is done in an appropriate work space away from foot traffic and exposure to bystanders.
- Disconnect all power and allow to sit for 5 minutes before you service this machine.
- Some components of the equipment can be heavy or awkward. Enlist the service of a second person when you do maintenance steps involving these components. Do not try to do heavy or awkward steps on your own.
- If replacement parts are necessary, use only genuine Nautilus replacement parts and hardware. Failure to use genuine replacement parts can cause a risk to users, keep the machine from operating correctly and will void the warranty.
- Be sure that all warning stickers and instructional placards applied to the product stay present and in good condition when doing maintenance or replacing components. If necessary request replacement warning stickers or placards from Nautilus customer service.
- Do not try to change the design or functionality of the machine being serviced as this can adversely effect user safety and will void the warranty.
- Do not use the machine until all shrouds, instructions, warning labels and correct functionality have been verified and tested for correct performance.

### Tools Required (not included)

#2 Phillips screwdriver

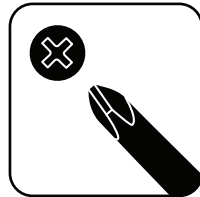

8300 Silicone Spray or Lube-N-Walk® Treadmill Lubrication Kit

6mm Hex Wrench



1. With power supplied to the machine and it turned on, adjust the Walking Deck Incline to a setting of '6'. To adjust, push the '6' Pre-Set Incline button, and then the Confirm Incline button. Allow the Walking Deck to adjust to the new incline height.

2. Unplug the power cord from the machine and wait 5 minutes. Place the power cord in a secure location.

**⚠ DANGER** To reduce the risk of electrical shock or unsupervised usage of the equipment, always unplug the power cord from the wall outlet and wait 5 minutes before cleaning, maintaining or repairing this machine. Place the power cord in a secure location.

3. Using a #2 Phillips screwdriver, remove the screw (indicated by ovals) from each of the Base Shrouds.

4. Remove the Base Shrouds from the machine.

5. Using a #2 Phillips screwdriver, remove the 10 indicated screws that secure the Motor Cover.

**Note:** There are 2 screws that secure the Motor Cover from the underside of the machine (see image to the right).

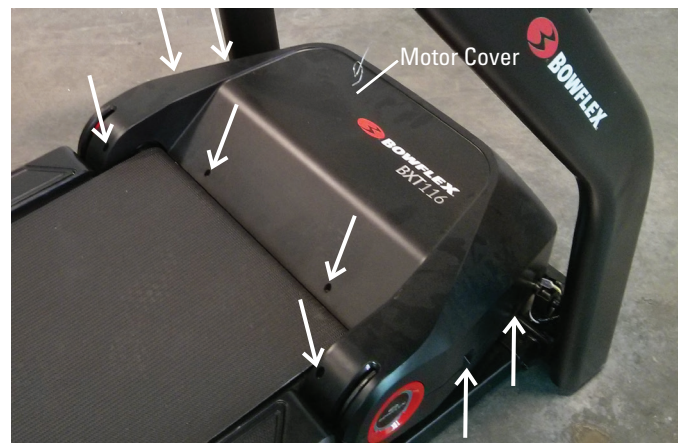

6. Gently release the front snaps (indicated by ovals) that secure the Motor Cover and pivot it back toward the walking belt until it releases. Remove from the machine.



7. Make sure that there is safe clearance around, on and above the treadmill. Make sure there is no object to spill or cause blockage from the fully folded position.

**!** Be sure there is adequate height clearance for the raised deck.

8. Using the support bar found below the rear of the walking belt, push the Deck Release Handle and lift the walking deck fully upward and engage the hydraulic lift. Be sure that the hydraulic lift is correctly locked in place. You will hear an audible click when the hydraulic lift shifts into the locked position.

**!** Use proper safety precautions and lifting techniques. Bend your knees and elbows, keep your back straight and pull up equally with both arms. Make sure that your own physical strength is capable of lifting the walking deck until it engages the locking mechanism. Use a second person if necessary.

**Do not use the walking belt or rear roller to lift the treadmill. These parts do not lock in place and can abruptly move. Injury to you or damage to the machine can occur.**

9. Make sure that the locking mechanism is engaged. Carefully pull back on the walking deck and make sure that it does not move. When you do this, keep clear of movement path in case the treadmill lock is not engaged.

**!** Do not lean against the treadmill when it is folded. Do not put items on it that could cause it to become unstable or fall.

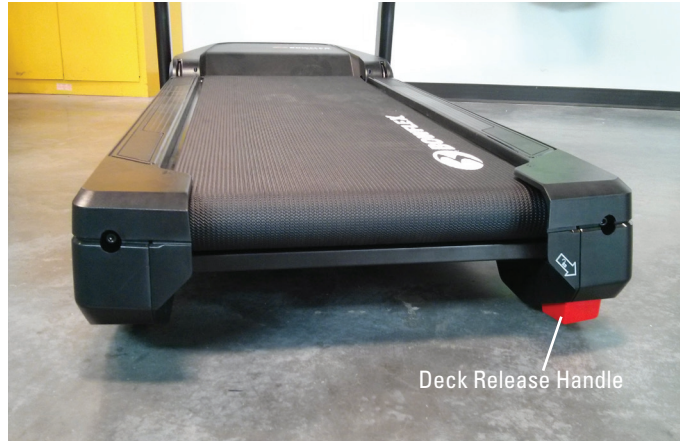

10. Using a #2 Phillips screwdriver, remove the two indicated screws from the Rear Roller Cover.

11. Remove the Rear Roller Cover noting how it attaches for re-assembly.

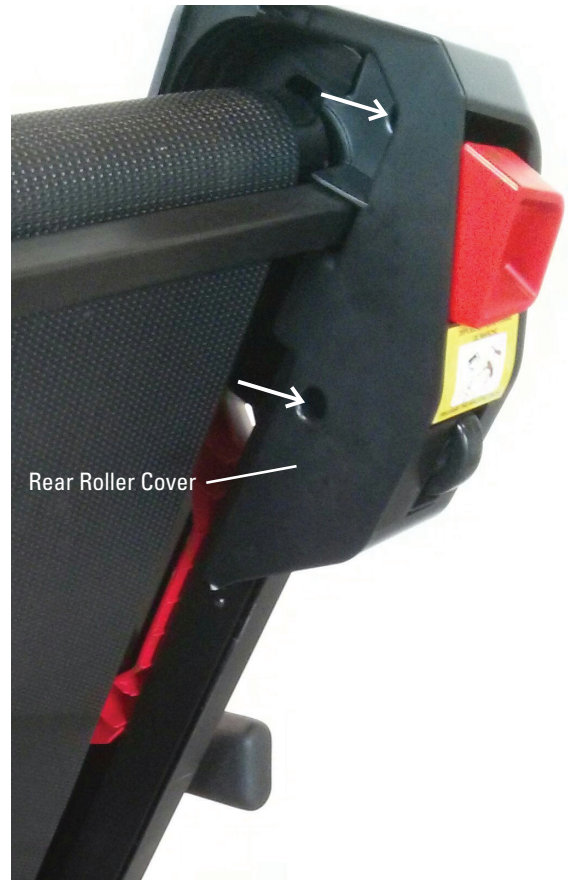

12. Using a #2 Phillips screwdriver, remove the 4 indicated screws that secure the Side Rail. Remove it from the machine.





13. Using a #2 Phillips screwdriver, remove the 4 indicated screws from the Lower Side Rail.

14. Remove the Lower Side Rail noting how it attaches for re-assembly.



15. Using a #2 Phillips screwdriver, remove the 5 indicated screws from the Deck Suspension Inserts.

16. Make sure there is sufficient space to lower the walking deck.

**⚠ Keep a minimum clearance behind the machine of 79" (2 m) and 24" (0.6 m) on each side. This is the recommended safe distance for access, movement and emergency dismounts from the machine.**

17. Make sure there is no object on or around the treadmill to spill or cause blockage from the fully unfolded position.

18. Slightly push the walking deck forward toward the console, and then push the Deck Release Handle until the locking tube releases and you can pull the walking deck away from the console. Hold up the rear of the walking deck, and move to the side of the machine.

**⚠ Keep clear of the movement path of the walking deck.**

19. The hydraulic lift is set up to drop gradually. Hold onto the walking deck until approximately 2/3 of the movement down. Make sure that you use proper lifting technique; bend your knees and keep your back straight. Be aware that the walking deck can possibly drop quickly in the last part of the movement.

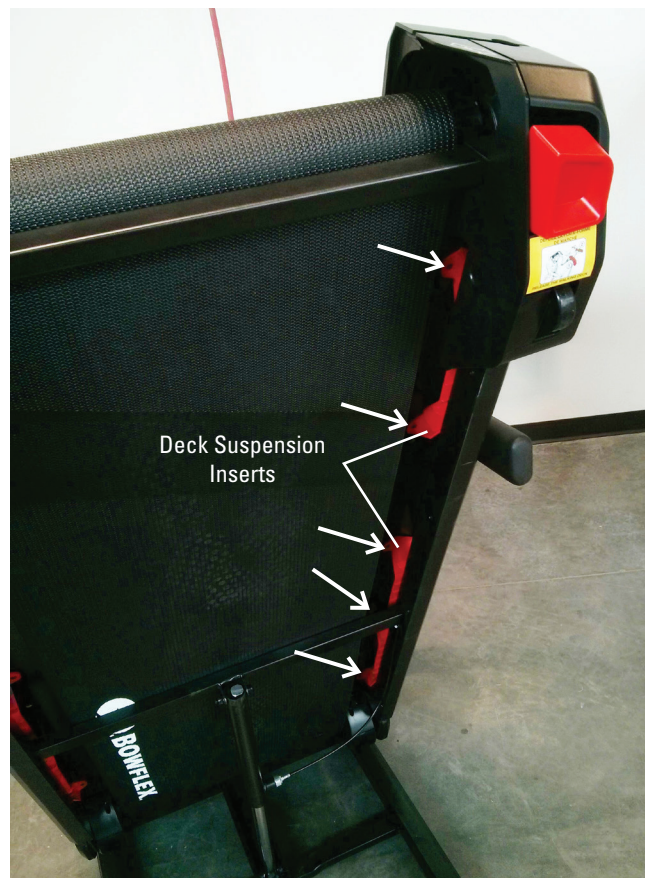

20. Using a 6mm hex wrench, remove the 3 indicated screws from each side of the Walking Deck.

21. Slide the old Walking Deck Assembly out of the Walking Belt, and flip over so the Walking Belt Guides are exposed.

**Note:** the Walking Deck is designed for wear on both sides of it. If this is the first time removing the Walking Deck, a replacement Deck may not be required. Flip the Walking Deck and use the unworn side as the “new Walking Deck”.



22. Using a #2 Phillips screwdriver, remove the Walking Belt Guides and attach them to the new Walking Deck in the same orientation.

23. Turn over the new Walking Deck Assembly, and replace it between the Walking Belt in the same orientation.

24. Using a 6mm hex wrench, re-install the 6 screws to the Deck.

25. Re-install all remaining parts that were removed in reverse order.

**Note:** Make sure the treadmill is located on a surface that is easy to clean.

26. Apply a few drops of the lubricant on the deck below the belt. Carefully lift the belt and apply a few drops of the lubricant the entire width of the belt. A very thin layer of silicone lubricant on the entire deck below the belt is desired.

**NOTICE:** Always use a 100% pure silicone lubricant. Do not use a degreaser like WD-40® as this could seriously impact performance. We can recommend that you use the following:

- 100% pure silicone, available at most hardware and auto parts stores.
- Lube-N-Walk® Treadmill Lubrication Kit, available from your local specialty fitness dealer or Nautilus, Inc.



**Silicone lubricant is not intended for human consumption. Keep out of reach of children. Store in a safe place.**

27. Manually rotate the belt 1/2 of the length of the belt and apply lubricant again.



**If you used spray lubricant, wait 5 minutes before turning on power to the machine to allow the aerosol to dissipate.**

28. Connect the power cord back into the machine and then into the wall outlet.

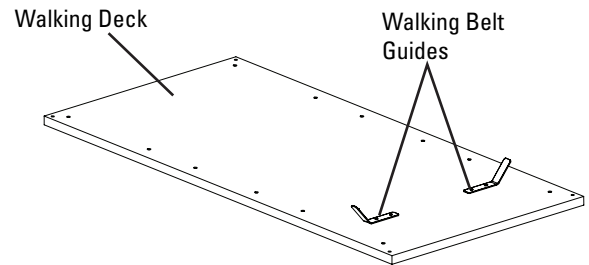

29. Turn on the power to the machine with the power switch.

30. Stay to one side of your machine and start the belt at the slowest speed. Let the belt operate for approximately 15 seconds.

 **Be sure not to touch the walking belt or step on the power cord. Keep bystanders and children away from the product you are servicing at all times.**

31. Switch off your machine.

32. Take care to clean up any excess lubricant from the deck.

 **To decrease the possibility of slipping, be sure the deck area is free from grease or oil. Clean off any excess oil from the machine surfaces.**

33. Final Inspection

Inspect your machine to ensure that all hardware is tight and components are properly assembled.

 **Do not use until the machine has been fully assembled and inspected for correct performance in accordance with the Owner's Manual.**