

| | | | |
|--|---------------------------|---------------------------|-----------|
| TITLE: EXP VIEW DWG- SCH 870 TREADMILL (MY'17) | | | |
| DRAWN J. Morgan | DOC. PART NO. 100519-W | PRODUCT SKU NO. 100519 | REV. C |
| DATE 06/27/2017 | | | |

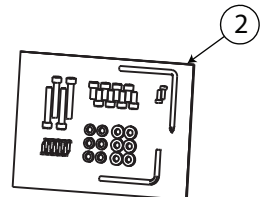

Individual components not to scale

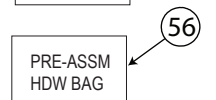
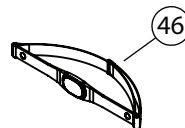
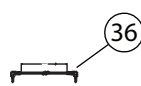
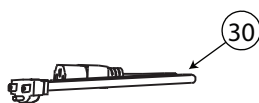
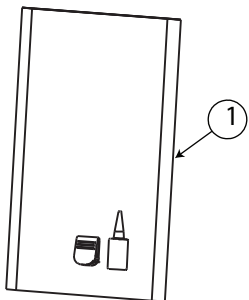
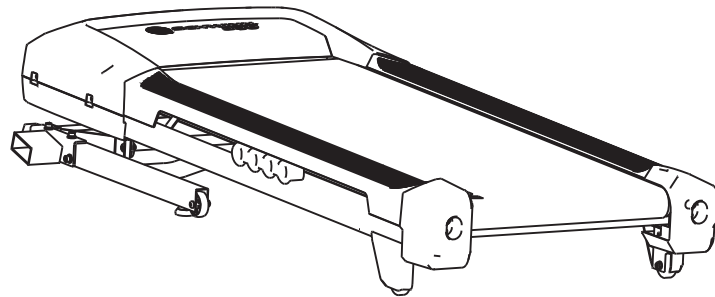
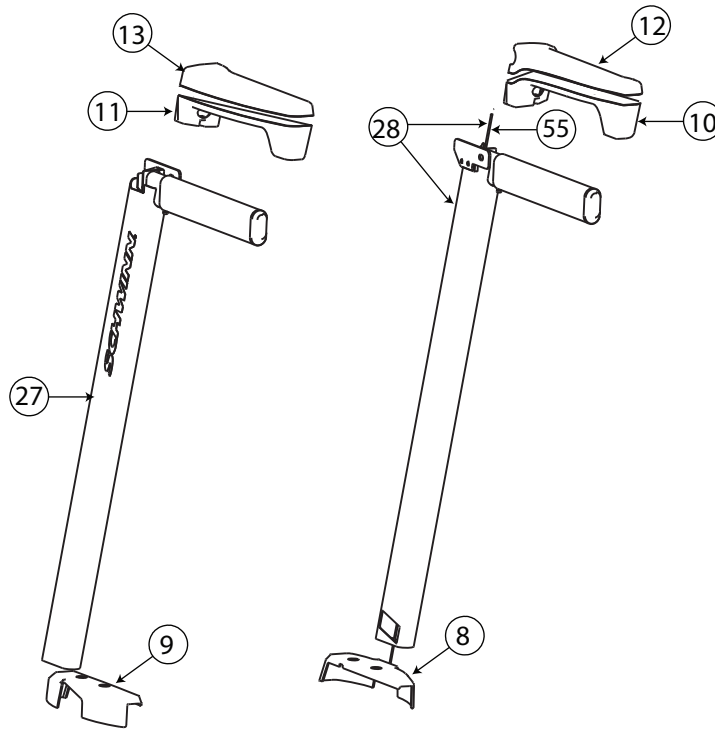
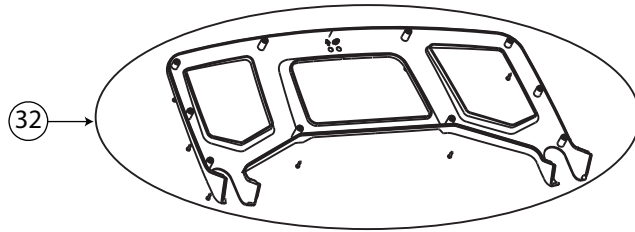
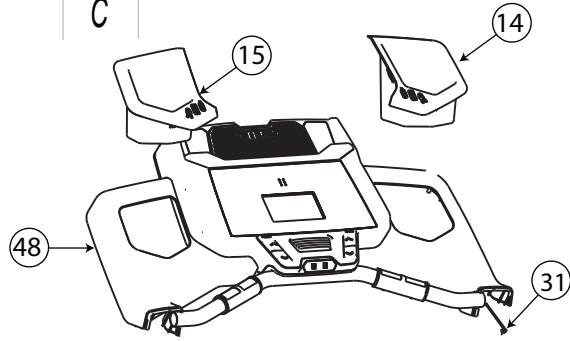