

## Table of Contents

Section Code	Section	Page Number
1	Important Safety Instructions	2
1	Safety Warning Labels and Serial Number	3
1	Specifications	3
1	Moving / Leveling the Machine	4
1	Maintenance	5
1	Maintenance Parts Exploded View	6
1	Troubleshooting	8
1	Console Setup Mode	10
1	Motor Control Board detail	11
1	Replacement Procedure Skill Level	12
	Mechanical / Modification Procedures	
2	Roller Wheel Maintenance Procedure	13
3	Adjust the Brake Assembly	16
4	Adjust the Leg Assembly Alignment	20
5	Install Felt Washers on Rollers	23
6	Reset the Console	25
7	Syncing the Console	26
	Part Replacement	
8	Replace the AC Inlet	28
9	Replace the Brake Assembly	31
10	Replace the Console Assembly	35
11	Replace the Console Display	37
12	Replace the Crank Arms	40
13	Replace the Drive Belt	44
14	Replace the Drive Pulley	50
15	Replace the Drive Pulley Hardware	58
16	Replace the Fan Assembly	64
17	Replace the Fan Belt	67
18	Replace the Fan Pulley	74
19	Replace the Frame Assembly	82
20	Replace the I/O Cable	93
21	Replace the Keypad Assembly	100
22	Replace the Pivot Arm	103
23	Replace the Roller Wheel Assembly	106
24	Replace Self-Tensioning Fan Belt	108
25	Replace the Servo Motor	116
26	Replace the Shrouds	119
27	Replace the Speed Sensor	125
28	Replace the Tensioner	128
29	Replace the Wireless Heart Rate Sensor	134

**NOTICE:** This document provides important safety instructions, adjustments, and general troubleshooting information for the maintenance of the Bowflex Max Trainer® M5.

**If you need assistance, please call Bowflex Customer Service at 1-800-605-3369.**



**This icon means a potentially hazardous situation which, if not avoided, could result in death or serious injury. Read and understand all Warnings on this machine.**

Nautilus, Inc., (800) 605-3369, www.NautilusInc.com - Customer Service: North America (800) 605-3369, csnl@nautilus.com | outside U.S. www.nautilusinternational.com | Printed in China | © 2014 Nautilus, Inc. | ® indicates trademarks registered in the United States. These marks may be registered in other nations or otherwise protected by common law. Bowflex, the B logo, and Bowflex Max Trainer are trademarks owned by or licensed to Nautilus, Inc.

---

## Important Safety Instructions



**This icon means a potentially hazardous situation which, if not avoided, could result in death or serious injury. Read and understand all Warnings on this machine.**

Before servicing or using this equipment, obey the following warnings:



**Read and understand the Service Manual before working on the machine. Failure to obey the instructions and safety warnings could cause injury to the service technician or bystanders.**

### **⚠ DANGER**

**To reduce the risk of electrical shock or unsupervised usage of the equipment, always unplug the power cord from the wall outlet and/or the machine and wait 5 minutes before cleaning, maintaining or repairing the machine. Place the power cord in a secure location.**

- Keep bystanders and children away from the product being serviced at all times.
- Make sure that the repair is done in an appropriate work space away from foot traffic and exposure to bystanders.
- Some components of the equipment can be heavy or awkward. Enlist the service of a second person when you do maintenance steps involving these components. Do not try to do heavy or awkward steps on your own.
- Use only replacement parts and hardware that are supplied or approved by Nautilus. Failure to use Nautilus-approved replacement parts can adversely affect the safety and functionality of the equipment creating a risk to users and will void the warranty.
- Be sure that all warning stickers and instructional placards applied to the product stay present and in good condition when doing maintenance or replacing components. If necessary, request replacement warning stickers or placards from Nautilus customer service.
- Do not try to change the design or functionality of the machine being serviced as this can adversely affect user safety and will void the warranty.
- Do not put the machine back in service until all shrouds, instructions, warning labels and correct functionality have been verified and tested for correct performance.

# SAFETY WARNING LABELS AND SERIAL NUMBER

## WARNING!

1. Prior to use, read and understand the Owner's Manual, including all Warnings.
2. Inspect product before use. Do not use if any parts are in need of repair.
3. Keep children and pets away from this machine at all times.
4. Not intended for use by anyone under 14 years of age.
5. This machine is for Home use only.
6. Use Caution when you use this equipment or serious injury can occur.
7. The maximum user weight for this machine is 136 Kg ( 300 lbs ).
8. Replace any "Caution", "Warning" or "Danger label that is illegible, damaged, or removed.
9. The heart rate displayed on the console is an approximation and should be used for reference only.
10. The Target LED Range is a suggested workout level, and should only be followed if your physical fitness level allows. Cease exercise if you feel faint or dizzy.
11. Consult a physician prior to using any exercise equipment.

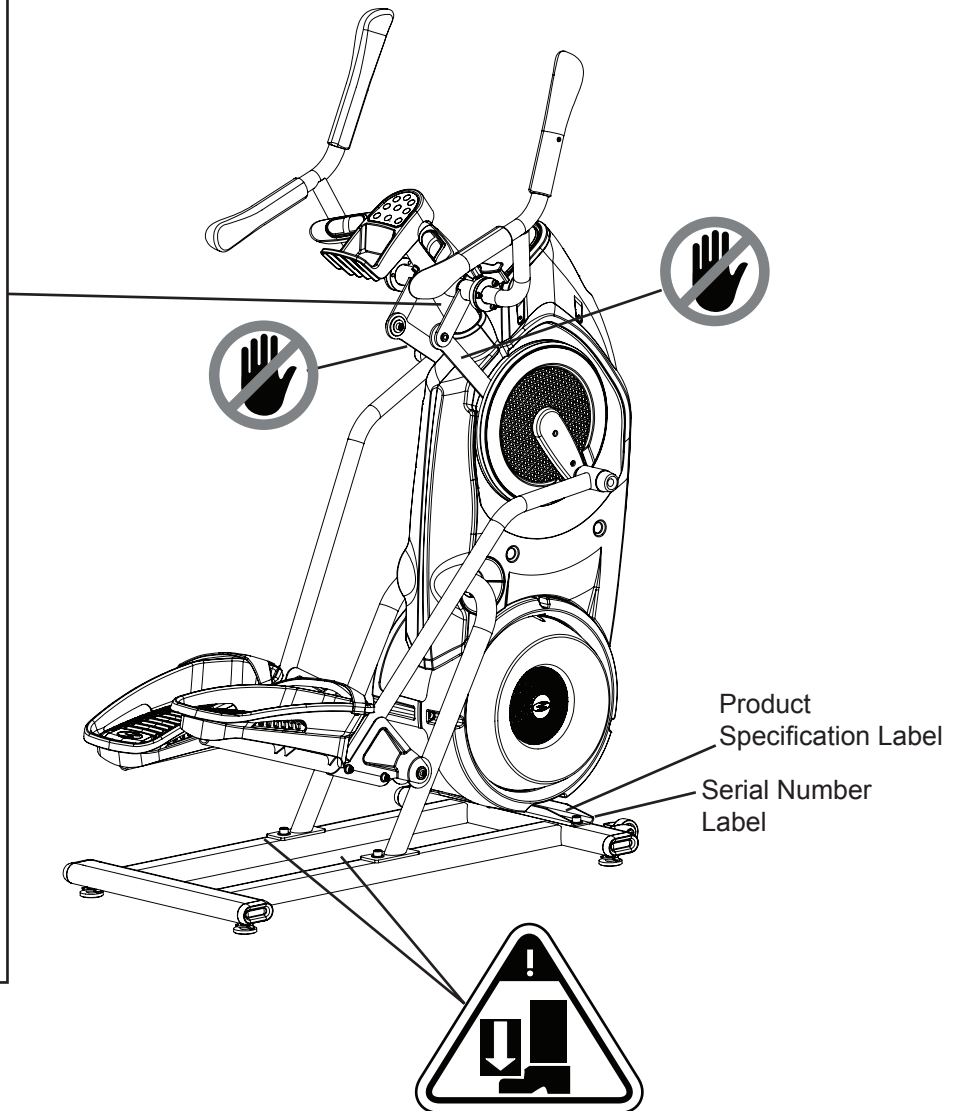

## SPECIFICATIONS

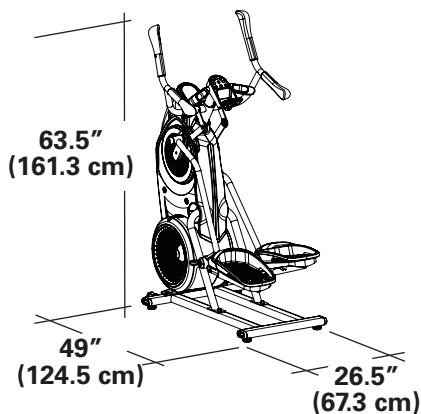

**Maximum User Weight:** 300 lbs. (136 kg)  
**Maximum Pedal Height:** 19.1 inches ( 48.5 cm)

**Power Requirements:**  
Operational Voltage: 9VDC  
Operating Current: 1500 mA

**Regulatory Approvals:**  
AC Power Adapter: UL listed, CSA certified (or equivalent), Rated 120V 60Hz Input, 9VDC, 1500mA Output. Class 2 or LPS.

## Moving the Machine

**⚠** The machine may be moved by one or more persons depending on their physical abilities and capacities. Make sure that you and others are all physically fit and able to move the machine safely.

1. Grasp the inner, unmoving part of the Pivot Assembly to carefully tilt the machine toward you onto the transport rollers.

**⚠** Be aware of the Handlebars and the weight of the machine before tilting the machine.

2. Push the machine into position.

3. Carefully lower the machine into position.

*NOTICE:* Be careful when you move the machine. All abrupt motions can affect the computer operation.

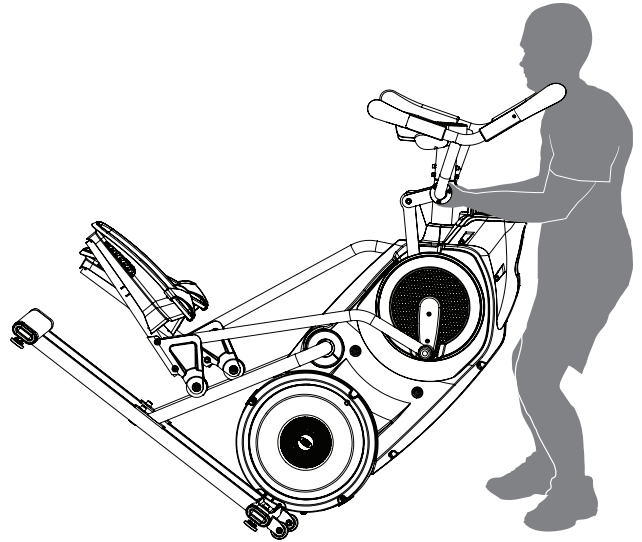

## Leveling the Machine

The machine needs to be leveled if your workout area is uneven or if the Rail Assembly is slightly off the floor. To adjust:

1. Place the machine in your workout area.

2. Loosen the locking nuts and adjust the levelers until they are evenly balanced in contact with the floor.

**⚠** Do not adjust the levelers to such a height that they detach or unscrew from the machine. Injury to you or damage to the machine can occur.

3. Tighten the locking nuts.

**⚠** Make sure the machine is level and stable before you exercise.

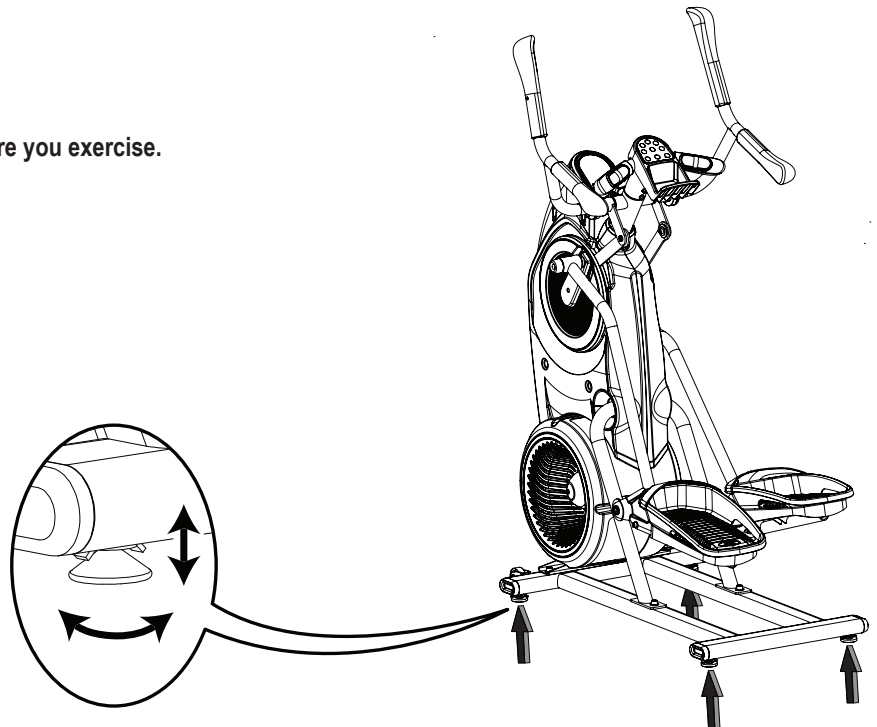

# MAINTENANCE

Read all maintenance instructions fully before you start any repair work. In some conditions, an assistant is required to do the necessary tasks.

**⚠** Equipment must be regularly examined for damage and repairs. The owner is responsible to make sure that regular maintenance is done. Worn or damaged components must be repaired or replaced immediately. Only manufacturer supplied components can be used to maintain and repair the equipment.

**⚠ DANGER** To reduce the risk of electrical shock or usage of the equipment, always unplug the power cord from the wall outlet and the machine and wait 5 minutes before cleaning, maintaining or repairing the machine. Place the power cord in a secure location.

**Daily:** Before each use, examine the exercise machine for loose, broken, damaged, or worn parts. Do not use if found in this condition. Repair or replace all parts at the first sign of wear or damage. After each workout, use a damp cloth to wipe your machine and Console free of moisture.

Note: Avoid excessive moisture on the Console.

**Weekly:** Check for smooth roller operation. Wipe the machine to remove dust, dirt, or grime. Clean the rails and surface of the rollers with a damp cloth.

**Note:** Do not use petroleum based products.

**Monthly or after 20 hours:** Make sure all bolts and screws are tight. Tighten as necessary.

NOTICE: Do not clean with a petroleum based solvent or an automotive cleaner. Be sure to keep the Console free of moisture.

# Maintenance Parts

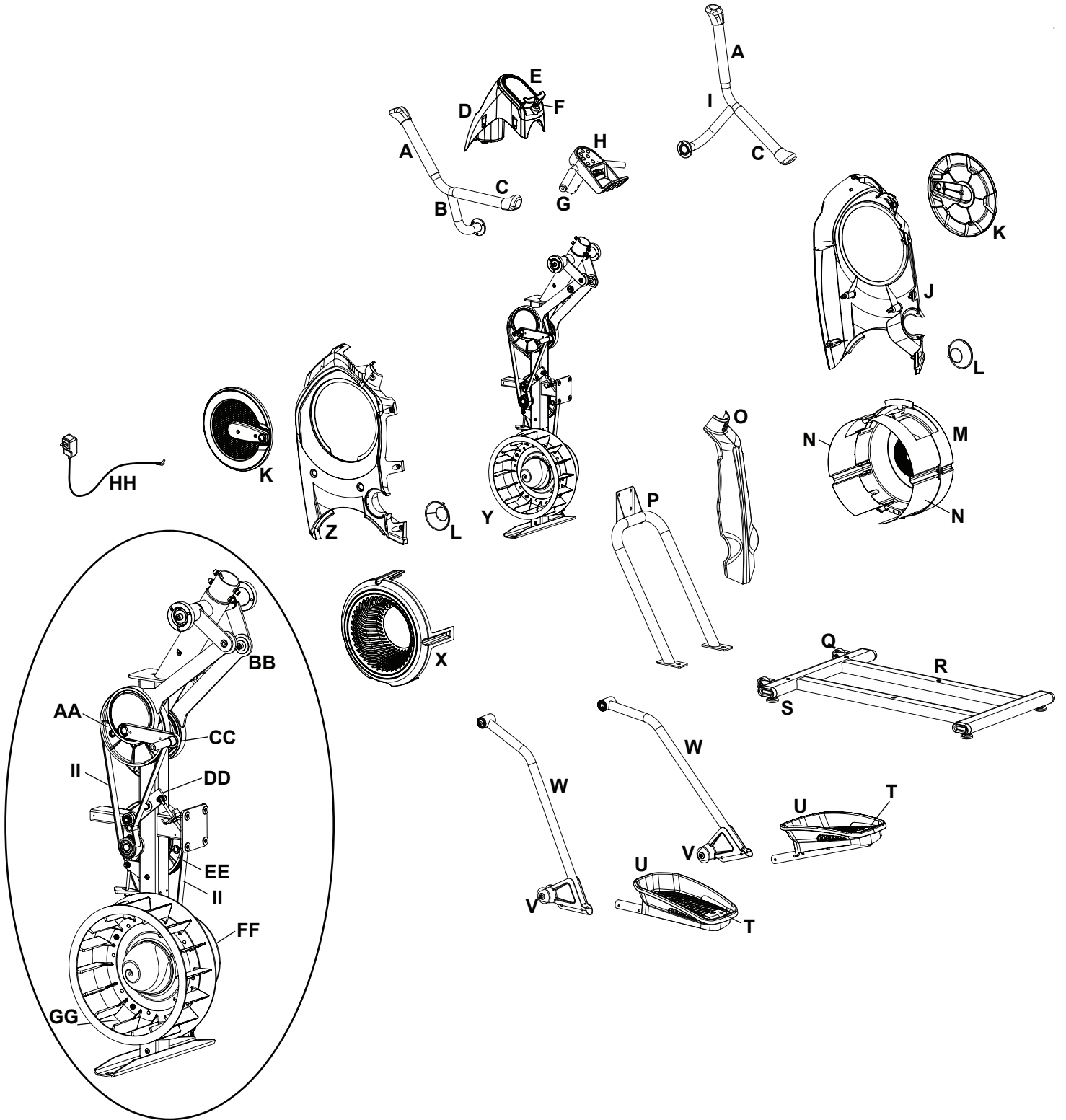

A	Upper Handle Grip	M	Shroud, Right Fan	Y	Fan Assembly
B	Handlebar, Left	N	Fan Assembly Inserts	Z	Shroud, Right
C	Lower Handle Grip	O	Shroud, Rear	AA	Drive Pulley, Upper
D	Console Shroud / Water Bottle Holder	P	Rail Assembly	BB	Arm Drive Assembly
E	Console Assembly	Q	Transport Wheel	CC	Crank Arm
F	Speaker	R	Stabilizer	DD	Tensioner
G	Handlebar, Static	S	Leveler	EE	Drive Pulley, Lower
H	Console Button Assembly	T	Foot Pad Insert	FF	Fan Back Plate
I	Handlebar, Right	U	Foot Pad	GG	Speed Sensor (behind Fan)
J	Shroud, Right	V	Roller	HH	Power Cord
K	Crank Cover	W	Leg	II	Drive Belt
L	Cap	X	Shroud, Left Fan		

## TROUBLESHOOTING

Condition/Problem	Things to Check	Solution
No display/partial display/unit will not turn on	Check electrical (wall) outlet	Make sure unit is plugged into a functioning wall outlet.
	Check connection at front of unit	Connection should be secure and undamaged. Replace adapter or connection at unit if either are damaged.
	Check data cable connections/orientation	Be sure cable is connected securely and oriented properly. Small latch on connector should line up and snap into place.
	Check data cable integrity	All wires in cable should be intact. If any are visibly crimped or cut, replace cable.
	Check console display for damage	Check for visual sign that console display is cracked or otherwise damaged. Replace Console if damaged.
	AC Adapter	Check for visual sign that AC Adapter is cracked or otherwise damaged. Replace AC Adapter if damaged.
	Console Display	If Console only has partial display and all connections are fine, replace the Console.
		If the above steps do not resolve the problem, contact Customer Care for further assistance.
No response on Console when button is pushed	Console Button Assembly	Try other buttons to get any response on the Console.
	Check data cable integrity from Console Button Assembly to Console	All wires in cable should be intact. If any are visibly crimped or cut, replace cable.
	Check data cable connections/orientation	Be sure cable is connected securely and oriented properly. Small latch on connector should line up and snap into place.
	Check console display for damage	Check for visual sign that console display is cracked or otherwise damaged. Replace Console if damaged.
	Check Console Button Assembly	Check for visual sign that the Console Button Assembly is otherwise damaged. Replace the Console Button Assembly if damaged.
		If the above steps do not resolve the problem, contact Customer Care for further assistance.
No speed/RPM reading	Check data cable integrity	All wires in cable should be intact. If any are cut or crimped, replace cable.
	Check data cable connections/orientation	Be sure cable is connected securely and oriented properly. Small latch on connector should line up and snap into place.
	Check magnet position (requires shroud removal)	Magnet should be in place on pulley.
	Check Speed Sensor (requires shroud removal)	Speed sensor should be aligned with magnet and connected to data cable. Realign sensor if necessary. Replace if there is any damage to the sensor or the connecting wire.
	Console Electronics	If tests reveal no other issues, contact Customer Care.
Unit operates but Telemetric HR not displayed	Chest Strap	Strap should be "POLAR®" compatible and uncoded. Make sure strap is directly against skin and contact area is wet.
	Interference	Try moving unit away from sources of interference (TV, Microwave, etc).
	Replace Chest Strap	If interference is eliminated and HR does not function, replace strap.



Condition/Problem	Things to Check	Solution
Console shuts off (enters sleep mode) while in use	Check electrical (wall) outlet	Make sure unit is plugged into a functioning wall outlet.
	Check connection at front of unit	Connection should be secure and undamaged. Replace adapter or connection at unit if either are damaged.
	Check data cable integrity	All wires in the cable should be intact. If any are cut or crimped, replace cable.
	Check data cable connections/orientation	Be sure cable is connected securely and oriented properly. Small latch on connector should line up and snap into place.
	Reset machine	Unplug unit from electrical outlet for 5 minutes. Reconnect to outlet.
	Check magnet position (requires shroud removal)	Magnet should be in place on pulley.
	Check Speed Sensor (requires shroud removal)	Speed sensor should be aligned with magnet and connected to data cable. Realign sensor if necessary. Replace if there is any damage to the sensor or the connecting wire.
Pedals will not move	Pedal locations	The Pedals may be "bottomed out". Safely grasp the Static Handlebars and apply your weight to the heel of the higher foot. While still grasping the Static Handlebar, lean back slightly applying more weight onto the heel. Once the Pedals begin to move, resume your intended workout.
Fan will not turn	Check for blockage of fan	Remove material from fan. Be sure not to move the Handlebars, Legs or Pedals.  <b>Be aware that the Fan, Handlebars, Legs and Pedals are connected and when either of these parts move the other does as well.</b> If necessary, detach the Shrouds to help with removal. Do not operate machine until Shrouds have been replaced.
Unit rocks/does not sit level	Check leveler adjustment	Adjust levelers until machine is level.
	Check surface under unit	Adjustment may not be able to compensate for extremely uneven surfaces. Move machine to level area.
Foot pedals loose/unit difficult to operate	Hardware	Tightly secure all hardware on the Pedal Arms and Handlebar Arms.
Rubbing sound outside of Shrouds during operation	Caps	Slightly loosen Caps on Crank Arms
Metallic rubbing sound from within Shrouds during operation	Brake bracket	Brake bracket needs to be aligned. Contact Customer Care for further assistance.
Machine seems to release Pedals for a moment during operation	Belt slip	Contact Customer Care for further assistance.
Workout results will not sync with Bluetooth® enabled device	Current console mode	Machine must be in Idle Mode to sync. Push the PAUSE/STOP button until the "GET READY" screen is displayed.
	Total time of workout	A workout must be longer than 1 minute to be saved and posted by the Console.
	Fitness machine	Unplug unit from electrical outlet for 5 minutes. Reconnect to outlet.
	Bluetooth® enabled device	Consult your device to be sure that the Bluetooth® wireless feature has been enabled on it.
	Fitness App	Review Specifications of Fitness App and confirm your device is compatible.
		Contact <a href="mailto:appsupport@nautilus.com">appsupport@nautilus.com</a> for further assistance.
	Sync fails	Review account and password for MyFitnessPal®

## **CONSOLE SETUP MODE**

The Console Setup Mode lets you control the sound settings, or see maintenance statistics (Total Run Hours and Software Version).

1. Push and hold down the Burn Rate/Increase and PAUSE/END buttons for 3 seconds while in the Power-Up Mode to go into the Console Setup Mode.

**Note:** Push PAUSE/END to exit the Console Setup Mode and return to the Power-Up Mode screen.

2. The Console display shows the Sound Settings prompt with the current setting. Push the Burn Rate/Increase or Burn Rate/Decrease buttons to change between the settings of "OFF" and "1" through "7". A setting of 7 is the loudest sound level.
3. Push START/ENTER to set.
4. The Console display shows the TOTAL RUN HOURS for the machine.
5. For the next prompt, push the START/ENTER button.
6. The Console display shows the Software Version prompt.
7. Push the START/ENTER button to exit the Console Setup Mode.

The Console will display the Power-Up Mode screen.

# MOTOR CONTROL BOARD (MCB) DETAIL

Note: The color of the Board does not matter.

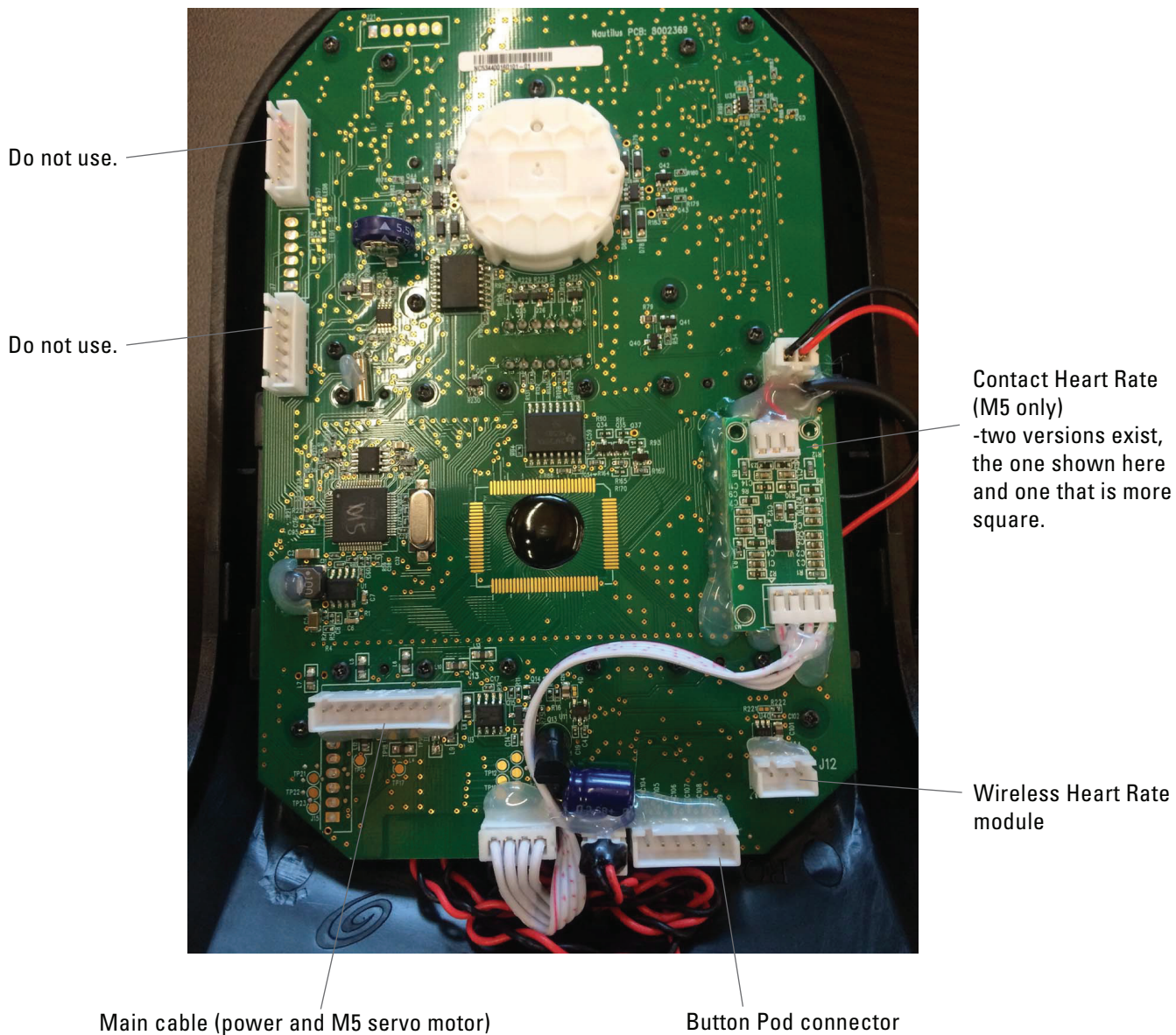

## ***REPLACEMENT PROCEDURE SKILL LEVEL***

- Level I : Low - very little mechanical knowledge or exposure.
- Level II : Intermediate - some experience with mechanical procedures.
- Level III : Advanced - knowledgeable about mechanical procedures.

**NOTICE:** This document provides instructions for the periodic maintenance of the Roller Wheels on the Bowflex Max Trainer® M3 / M5. High intensity users will want to perform this procedure every 3 to 6 months.

**If you need assistance, please call Bowflex Customer Service at 1-800-605-3369.**



**This icon means a potentially hazardous situation which, if not avoided, could result in death or serious injury. Read and understand all Warnings on this machine.**

Nautilus, Inc., (800) NAUTILUS / (800) 628-8458, www.NautilusInc.com - Customer Service: North America (800) 605-3369, csnls@nautilus.com | outside U.S. www.nautilusinternational.com | Printed in China | © 2014 Nautilus, Inc. | ® indicates trademarks registered in the United States. These marks may be registered in other nations or otherwise protected by common law. Bowflex, the B logo, and Bowflex Max Trainer are trademarks owned by or licensed to Nautilus, Inc.

## Important Safety Instructions - Before servicing or using this equipment, obey the following warnings:



**This icon means a potentially hazardous situation which, if not avoided, could result in death or serious injury. Read and understand all Warnings on this machine.**

- Read and understand the Part Replacement Procedure before working on the machine. Failure to obey the instructions and safety warnings could cause injury to the service technician or bystanders.
- Keep bystanders and children away from the product being serviced at all times.
- Make sure that the repair is done in an appropriate work space away from foot traffic and exposure to bystanders.
- Disconnect all power and allow to sit for 5 minutes before you service this machine.
- Some components of the equipment can be heavy or awkward. Enlist the service of a second person when you do maintenance steps involving these components. Do not try to do heavy or awkward steps on your own.
- If replacement parts are necessary, use only genuine Nautilus replacement parts and hardware. Failure to use genuine replacement parts can cause a risk to users, keep the machine from operating correctly and will void the warranty.
- Be sure that all warning stickers and instructional placards applied to the product stay present and in good condition when doing maintenance or replacing components. If necessary request replacement warning stickers or placards from Nautilus customer service.
- Do not try to change the design or functionality of the machine being serviced as this can adversely effect user safety and will void the warranty.
- Do not use the machine until all shrouds, instructions, warning labels and correct functionality have been verified and tested for correct performance.

## Tools and Items Required (not included)

(2) 6mm hex wrenches



Multi-purpose Mineral Oil

Towel or rag (disposable)

1. Unplug the power cord from the machine and wait 5 minutes.

2. Using two 6mm hex wrenches, remove the Wheel Assembly from the Pedal Arm. Place the components onto a disposable towel or rag. Be sure not to get any oil onto your clothing.

**!** In order to avoid possible serious injury when removing the Wheel Assembly, be careful to avoid fingers or hands being caught or pinched.

**!** Be aware that the Pedal Arms and the Upper Handlebars are connected and when either of these parts move the other does as well.

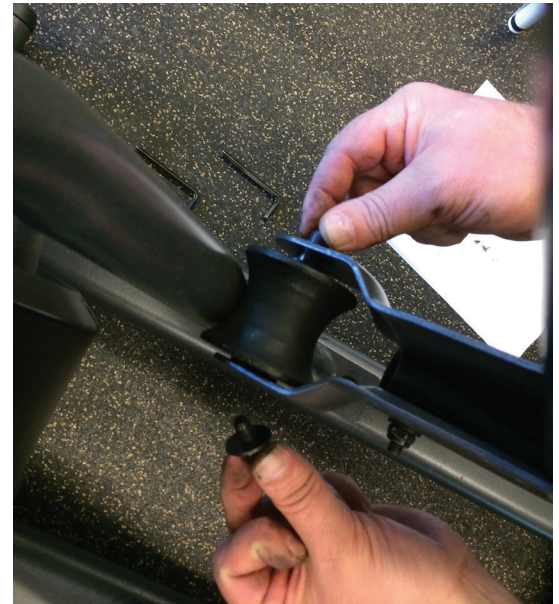

Be sure to remove all of the components of the Wheel Assembly from the Pedal Arm. (See image for all parts.)

**Note:** the Larger Washers may stick to the Wheel Bracket on the Pedal Arm or to the Wheel.

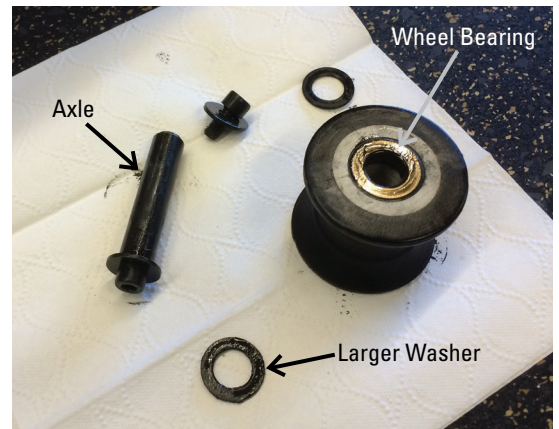

3. Using a clean rag or paper towel, clean both the Axle and the Wheel Bearing (including the inner edge). Wipe off any residue or debris.

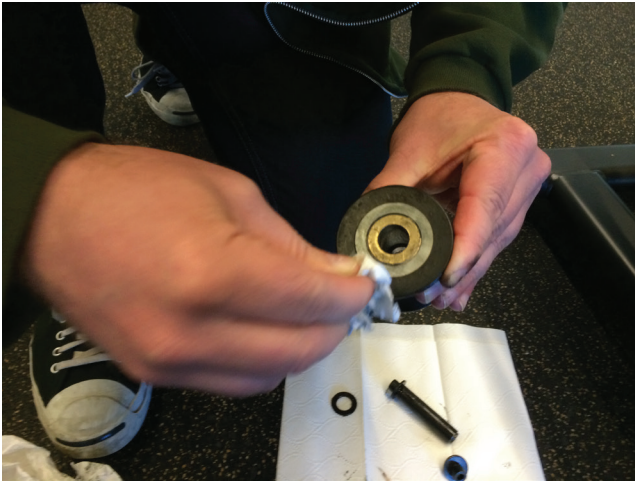

4. Apply one drop of Multi-purpose Mineral Oil to the inside of the Wheel Bearing (Areas 1 and 2), which is the surface that contacts the Axle.

Apply 4 drops of oil in the space between the Wheel Bearings (Area 3).

Apply a thin coating of oil to the length of the Axle (Area 4).

**Note: Do not allow any oil onto the outside material of the Wheel.**

**Do not use any silicone-based lubricant or grease.**

**Use a disposable towel or rag to prevent any oil from getting onto clothing or area.**

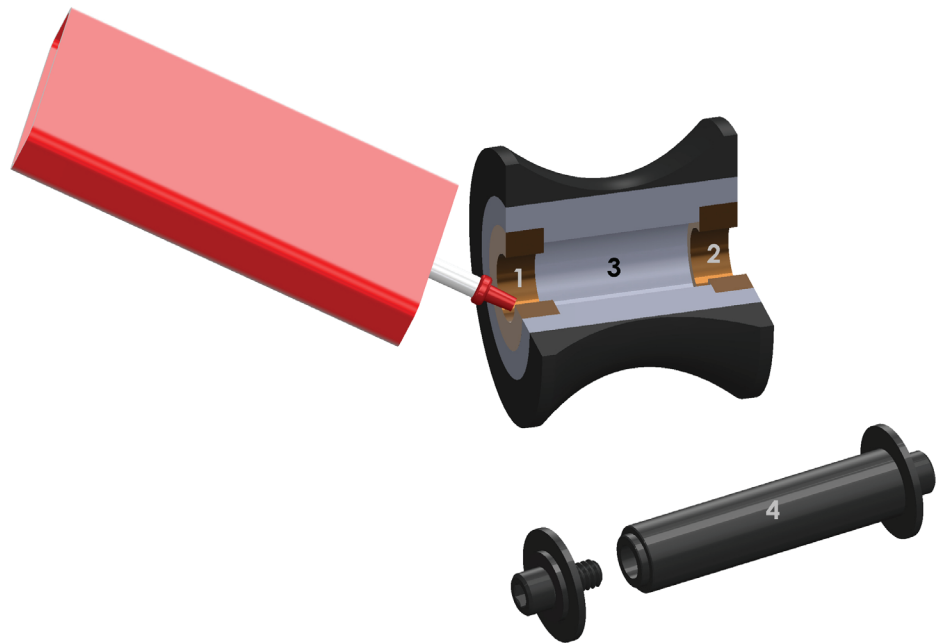

5. Re-assemble the Wheel Assembly. Be sure that the Larger Washers are placed between the Wheel and the Wheel Bracket. Spin the Wheel a couple times by hand to help the lubricant distribute evenly.

6. Final Inspection

Inspect your machine to ensure that all hardware is tight and components are properly assembled.

 **Do not use until the machine has been fully assembled and inspected for correct performance in accordance with the Owner's Manual.**

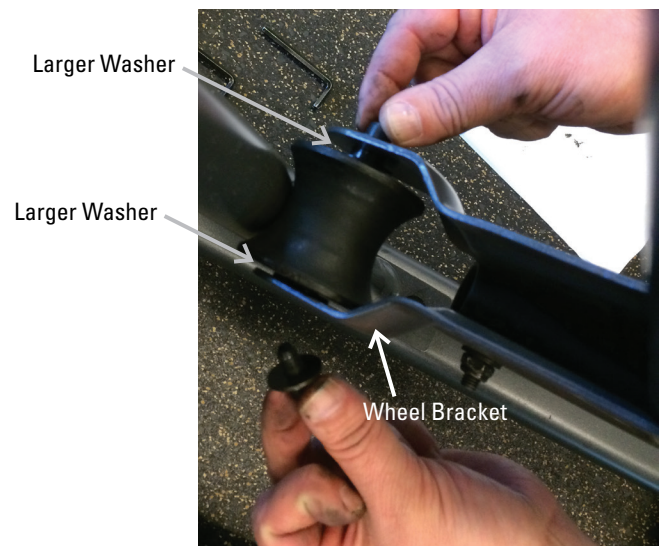

**NOTICE:** This document provides instructions for the adjustment of the Brake Assembly on the Bowflex Max Trainer® M3 / M5.

**If you need assistance, please call Bowflex Customer Service at 1-800-605-3369.**

 **This icon means a potentially hazardous situation which, if not avoided, could result in death or serious injury. Read and understand all Warnings on this machine.**

Nautilus, Inc., (800) 605-3369, www.NautilusInc.com - Customer Service: North America (800) 605-3369, csnl@nautilus.com | outside U.S. www.nautilusinternational.com | Printed in China | © 2014 Nautilus, Inc. | ® indicates trademarks registered in the United States. These marks may be registered in other nations or otherwise protected by common law. Bowflex, the B logo, and Bowflex Max Trainer are trademarks owned by or licensed to Nautilus, Inc.

## Important Safety Instructions - Before servicing or using this equipment, obey the following warnings:

 **This icon means a potentially hazardous situation which, if not avoided, could result in death or serious injury. Read and understand all Warnings on this machine.**

- Read and understand the Part Replacement Procedure before working on the machine. Failure to obey the instructions and safety warnings could cause injury to the service technician or bystanders.
- Keep bystanders and children away from the product being serviced at all times.
- Make sure that the repair is done in an appropriate work space away from foot traffic and exposure to bystanders.
- Disconnect all power and allow to sit for 5 minutes before you service this machine.
- Some components of the equipment can be heavy or awkward. Enlist the service of a second person when you do maintenance steps involving these components. Do not try to do heavy or awkward steps on your own.
- If replacement parts are necessary, use only genuine Nautilus replacement parts and hardware. Failure to use genuine replacement parts can cause a risk to users, keep the machine from operating correctly and will void the warranty.
- Be sure that all warning stickers and instructional placards applied to the product stay present and in good condition when doing maintenance or replacing components. If necessary request replacement warning stickers or placards from Nautilus customer service.
- Do not try to change the design or functionality of the machine being serviced as this can adversely effect user safety and will void the warranty.
- Do not use the machine until all shrouds, instructions, warning labels and correct functionality have been verified and tested for correct performance.

### Tools Required (not included)

#2 Phillips screwdriver



10mm hex wrench



8mm open ended wrench





**Note:** The Bowflex Max Trainer® M3 is used in the following images. The procedure is the same for the M5 model.

1. With power supplied to the machine, adjust the resistance to the maximum setting.

2. Unplug the AC Adapter from the machine and wait 5 minutes.

3. Using a #2 Phillips screwdriver, remove the indicated (by ovals) screws and only loosen the lowest indicated screw (arrow) from the Right Fan Cover.

**Note:** Loosen the lowest screw by at least 3 full rotations.



4. The Right Fan Cover has a tab that needs to be pushed upward to clear the loosened screw. While pushing up on the tab, remove the Right Fan Cover from the assembly.

**Note:** the AC Power Cable is attached to the inside of the Right Fan Cover. Be sure not to crimp the cable by placing the Right Fan Cover close to the front of the machine.

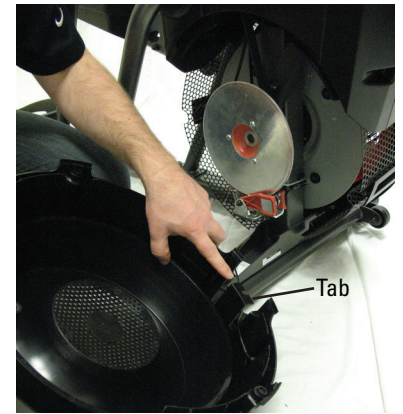
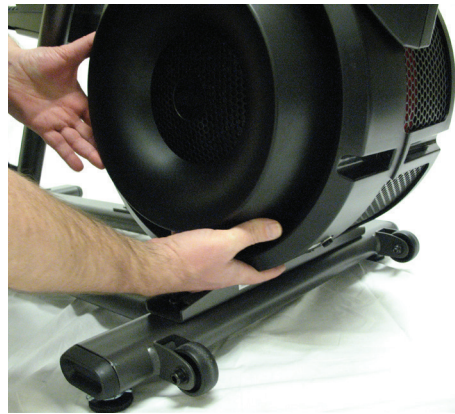

5. At the maximum resistance setting, the outer edge of the Brake Magnet should line up with the outer edge of the Brake Disc.

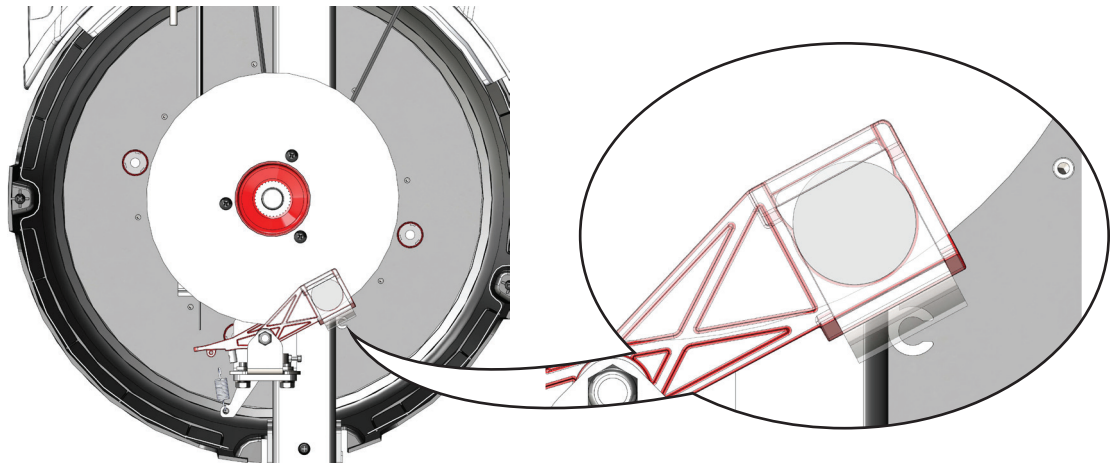

6. If the Brake Assembly needs to be adjusted, use a 8mm open ended wrench to loosen the Brake Cable Securing Nut. Turn the Adjustment Barrel by hand until the magnet is placed correctly.

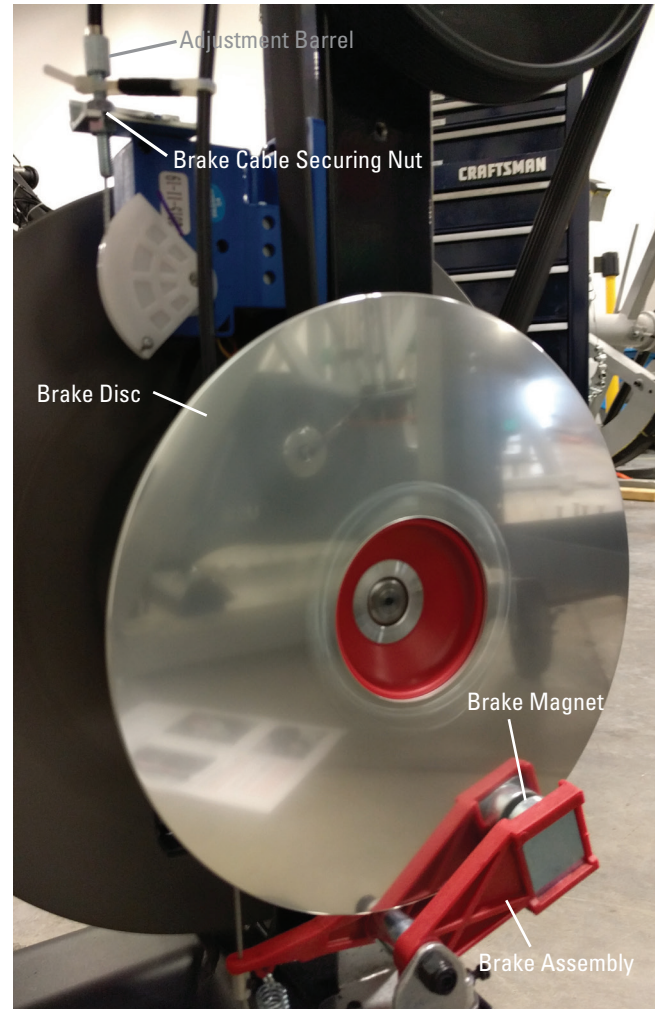

7. Carefully rotate the Brake Disc. If the Brake Disc does not rub against the Brake Magnet, skip to step 10.

 **Keep fingers out of any pinch opportunities when rotating the Brake Disc.**

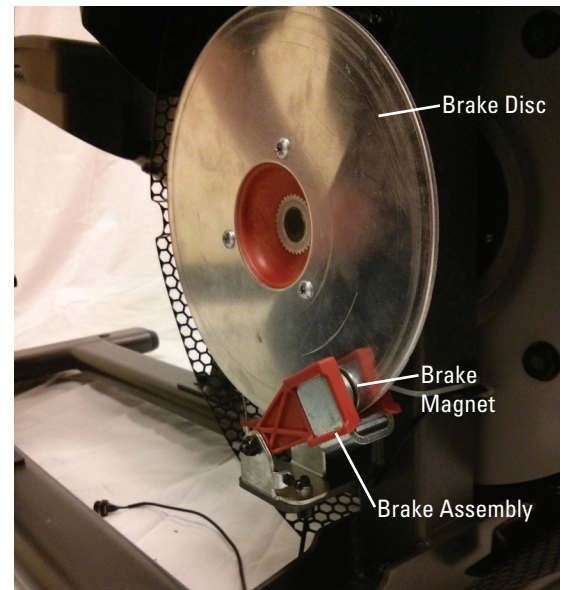

8. The Brake Magnets should be aligned with the Brake Disc and centered around the Brake Disc.

9. If the Brake Assembly only needs to be slightly adjusted, loosen the front screw that secures the Brake Assembly using a 10mm hex wrench. Rotate the Brake Assembly until the Magnets are aligned and of equal distance from the Brake Disc.

If the Brake Assembly must be fully shifted, loosen the 2 screws (indicated by arrows) that secure the assembly and shift it until centered and aligned with the Brake Disc. Fully tighten the hardware.

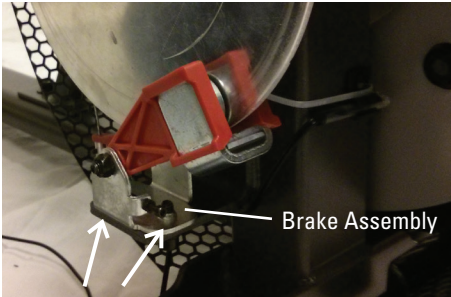

Rotate the Brake Disc to be sure it does not make contact with the magnets. If further adjustment is needed, repeat step 8.

10. Installation is the reverse procedure.

#### 11. Final Inspection

Inspect your machine to ensure that all hardware is tight and components are properly assembled.



**Do not use until the machine has been fully assembled and inspected for correct performance in accordance with the Owner's Manual.**

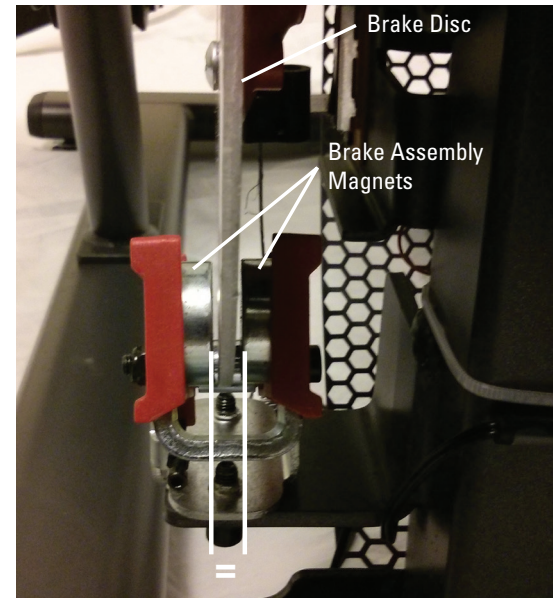

**NOTICE:** This document provides instructions for the adjustment of the Leg Assembly Alignment on the Bowflex Max Trainer® M3 / M5. The Rollers on the Leg Assemblies may be slightly “off”, or not fully centered onto the Rail Assembly. This procedure may assist with this condition.

**If you need assistance, please call Bowflex Customer Service at 1-800-605-3369.**



**This icon means a potentially hazardous situation which, if not avoided, could result in death or serious injury. Read and understand all Warnings on this machine.**

Nautilus, Inc., (800) NAUTILUS / (800) 628-8458, www.NautilusInc.com - Customer Service: North America (800) 605-3369, csnls@nautilus.com | outside U.S. www.nautilusinternational.com | Printed in China | © 2014 Nautilus, Inc. | ® indicates trademarks registered in the United States. These marks may be registered in other nations or otherwise protected by common law. Bowflex, the B logo, and Bowflex Max Trainer are trademarks owned by or licensed to Nautilus, Inc.

### Important Safety Instructions - Before servicing or using this equipment, obey the following warnings:



**This icon means a potentially hazardous situation which, if not avoided, could result in death or serious injury. Read and understand all Warnings on this machine.**

- Read and understand the Part Replacement Procedure before working on the machine. Failure to obey the instructions and safety warnings could cause injury to the service technician or bystanders.
- Keep bystanders and children away from the product being serviced at all times.
- Make sure that the repair is done in an appropriate work space away from foot traffic and exposure to bystanders.
- Disconnect all power and allow to sit for 5 minutes before you service this machine.
- Some components of the equipment can be heavy or awkward. Enlist the service of a second person when you do maintenance steps involving these components. Do not try to do heavy or awkward steps on your own.
- If replacement parts are necessary, use only genuine Nautilus replacement parts and hardware. Failure to use genuine replacement parts can cause a risk to users, keep the machine from operating correctly and will void the warranty.
- Be sure that all warning stickers and instructional placards applied to the product stay present and in good condition when doing maintenance or replacing components. If necessary request replacement warning stickers or placards from Nautilus customer service.
- Do not try to change the design or functionality of the machine being serviced as this can adversely effect user safety and will void the warranty.
- Do not use the machine until all shrouds, instructions, warning labels and correct functionality have been verified and tested for correct performance.

### Tools Required (not included)

#2 Phillips screwdriver

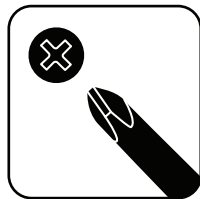

6mm hex wrench  
8mm hex wrench



#2 standard screwdriver



**Note:** The Bowflex Max Trainer® M3 is used in the following images. The adjustment procedure is the same for the M5 model.

If the Rollers seem to be “off” and not fully tracked on the Rail Assembly, this procedure may assist.

1. Unplug the AC Adapter from the machine and wait 5 minutes.

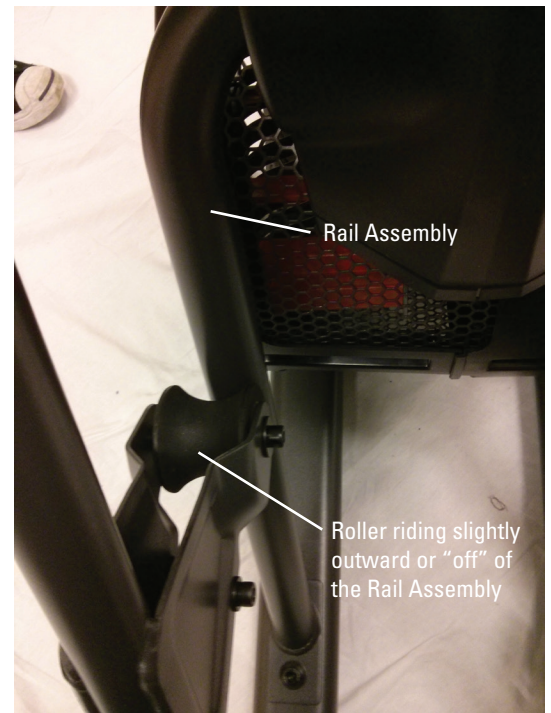

2. Using a #2 Phillips screwdriver, remove the 1 indicated screw from the Rear Shroud.

3. Carefully remove the Rear Shroud from the machine. Place a standard screwdriver behind and near the middle of the Rear Shroud and gently pry until it just releases. Then move the screwdriver to the bottom and gently pry until the Rear Shroud comes off.

4. Remove the Caps from the machine.



5. Using a 6mm hex wrench, slightly loosen the indicated bolts that secure the Rail Assembly to the Frame Assembly.

 **Do not fully remove the hardware.**

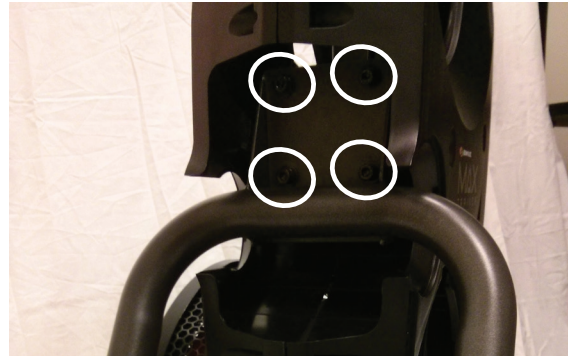

6. Using a 8mm hex wrench, slightly loosen the indicated bolts that secure the Rail Assembly to the Base Assembly.

 **Do not fully remove the hardware.**



7. Shift the Rail Assembly back and forth, or “wiggle”, until it seems to settle into the correct configuration. The Rollers will have adjusted with the Rail Assembly, and should be more “on” with the groove of the Roller centered onto the Rail Assembly.

8. Installation is the reverse procedure.

9. Final Inspection

Inspect your machine to ensure that all hardware is tight and components are properly assembled.

 **Do not use until the machine has been fully assembled and inspected for correct performance in accordance with the Owner’s Manual.**



**NOTICE:** This document provides instructions for the installation of Felt Washers on the Roller Wheel Axle of the Bowflex Max Trainer® machine. The Felt Washers will reduce the sound of when a Roller Wheel Assembly contacts the Wheel Bracket.

If you need assistance, please call **Bowflex Customer Service at 1-800-605-3369.**

 **This icon means a potentially hazardous situation which, if not avoided, could result in death or serious injury. Read and understand all Warnings on this machine.**

Nautilus, Inc., (800) 605-3369, www.NautilusInc.com - Customer Service: North America (800) 605-3369, csnl@nautilus.com | outside U.S. www.nautilusinternational.com | Printed in China | © 2014 Nautilus, Inc. | ® indicates trademarks registered in the United States. These marks may be registered in other nations or otherwise protected by common law. Bowflex, the B logo, and Bowflex Max Trainer are trademarks owned by or licensed to Nautilus, Inc.

### Important Safety Instructions - Before servicing or using this equipment, obey the following warnings:

 **This icon means a potentially hazardous situation which, if not avoided, could result in death or serious injury. Read and understand all Warnings on this machine.**

- Read and understand the Part Replacement Procedure before working on the machine. Failure to obey the instructions and safety warnings could cause injury to the service technician or bystanders.
- Keep bystanders and children away from the product being serviced at all times.
- Make sure that the repair is done in an appropriate work space away from foot traffic and exposure to bystanders.
- Disconnect all power and allow to sit for 5 minutes before you service this machine.
- Some components of the equipment can be heavy or awkward. Enlist the service of a second person when you do maintenance steps involving these components. Do not try to do heavy or awkward steps on your own.
- If replacement parts are necessary, use only genuine Nautilus replacement parts and hardware. Failure to use genuine replacement parts can cause a risk to users, keep the machine from operating correctly and will void the warranty.
- Be sure that all warning stickers and instructional placards applied to the product stay present and in good condition when doing maintenance or replacing components. If necessary request replacement warning stickers or placards from Nautilus customer service.
- Do not try to change the design or functionality of the machine being serviced as this can adversely effect user safety and will void the warranty.
- Do not use the machine until all shrouds, instructions, warning labels and correct functionality have been verified and tested for correct performance.

### Tools (not included)

(2) 6mm hex wrenches



1. Unplug the power cord from the machine and wait 5 minutes.

2. Using two 6mm hex wrenches, remove the indicated hardware from the Wheel Bracket that attaches the Roller Wheel Assembly.

**!** In order to avoid possible serious injury when removing the hardware from the Roller Wheel Assemblies, be careful to avoid fingers or hands being caught or pinched. Also be aware that the Legs and the Upper Handlebars are connected and when either of these parts move the other does as well.

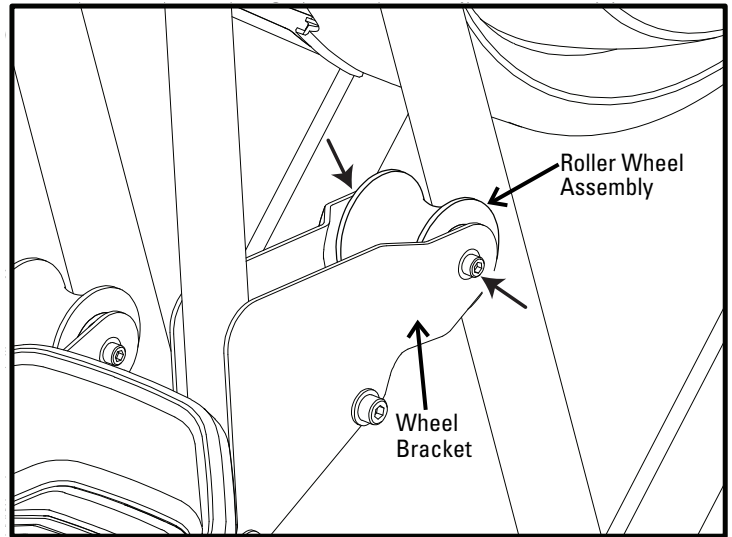

3. If there was a Large Washer between the Roller Wheel and the Wheel Bracket, discard them. They are NOT reused.

4. Install the Felt Washers on the Axle between the Roller Wheel Assembly and the Wheel Bracket.

The Wheel Bracket is designed so the Axle can only be inserted from one side.

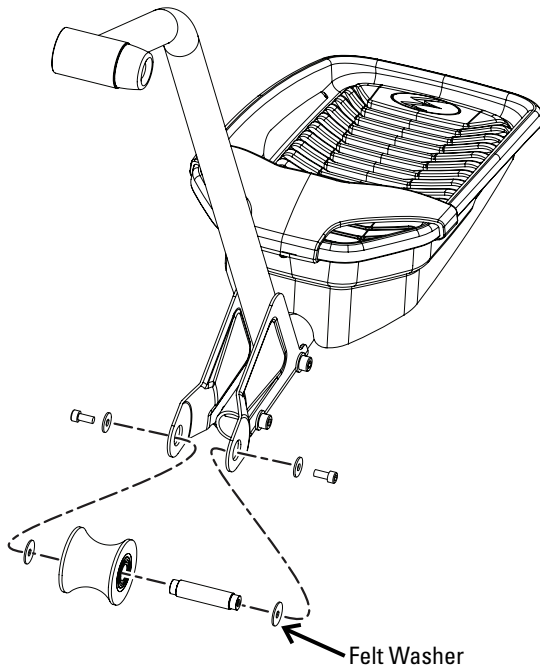
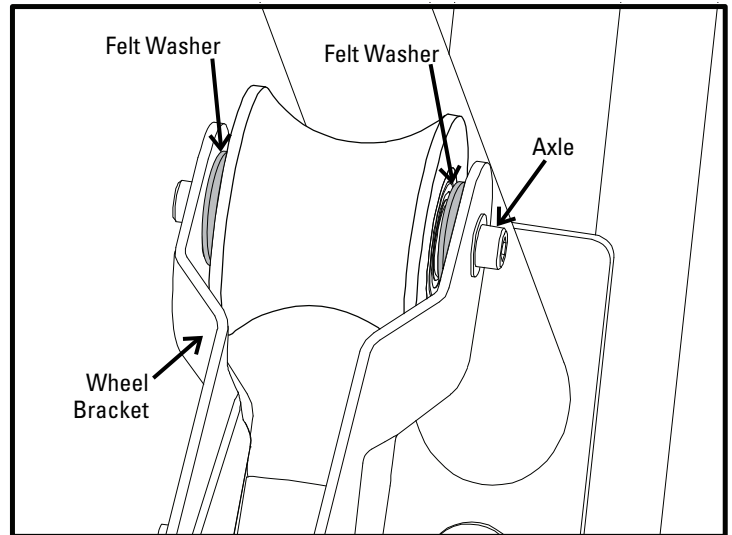

5. Re-attach the hardware and fully tighten using two 6mm hex wrenches.

6. Final Inspection

Inspect your machine to ensure that all hardware is tight and components are properly assembled.

**!** Do not use until the machine has been fully assembled and inspected for correct performance in accordance with the Owner's Manual.



**NOTICE:** This document provides instructions to reset the Console to the manufactured settings on the Bowflex Max Trainer® M3 / M5. Be aware that all information will be erased on the Console.

**If you need assistance, please call Bowflex Customer Service at 1-800-605-3369.**



**This icon means a potentially hazardous situation which, if not avoided, could result in death or serious injury. Read and understand all Warnings on this machine.**

Nautilus, Inc., (800) NAUTILUS / (800) 628-8458, www.NautilusInc.com - Customer Service: North America (800) 605-3369, csnls@nautilus.com | outside U.S. www.nautilusinternational.com | Printed in China | © 2014 Nautilus, Inc. | ® indicates trademarks registered in the United States. These marks may be registered in other nations or otherwise protected by common law. Bowflex, the B logo, and Bowflex Max Trainer are trademarks owned by or licensed to Nautilus, Inc.

### **Important Safety Instructions - Before servicing or using this equipment, obey the following warnings:**



**This icon means a potentially hazardous situation which, if not avoided, could result in death or serious injury. Read and understand all Warnings on this machine.**

- Read and understand the Part Replacement Procedure before working on the machine. Failure to obey the instructions and safety warnings could cause injury to the service technician or bystanders.
- Keep bystanders and children away from the product being serviced at all times.
- Make sure that the repair is done in an appropriate work space away from foot traffic and exposure to bystanders.
- Some components of the equipment can be heavy or awkward. Enlist the service of a second person when you do maintenance steps involving these components. Do not try to do heavy or awkward steps on your own.
- If replacement parts are necessary, use only genuine Nautilus replacement parts and hardware. Failure to use genuine replacement parts can cause a risk to users, keep the machine from operating correctly and will void the warranty.
- Be sure that all warning stickers and instructional placards applied to the product stay present and in good condition when doing maintenance or replacing components. If necessary request replacement warning stickers or placards from Nautilus customer service.
- Do not try to change the design or functionality of the machine being serviced as this can adversely effect user safety and will void the warranty.
- Do not use the machine until all shrouds, instructions, warning labels and correct functionality have been verified and tested for correct performance.

**Note:** For the Bowflex Max Trainer® M5, use the START/ENTER button for all references of the ENTER button.

1. With the machine at the Power-Up Mode screen, push and hold down the Burn Rate/Increase and PAUSE/END buttons for 3 seconds to go into the Console Setup Mode.

**Note:** Push PAUSE/END to exit the Console Setup Mode and return to the Power-Up Mode screen.

2. The Console display shows the Sound Settings prompt with the current setting.
3. Push ENTER.
4. The Console display shows the TOTAL RUN HOURS for the machine.
5. Push ENTER.
6. The Console display shows the Software Version prompt.
7. Push and hold down the Burn Rate/Increase and PAUSE/END buttons for three seconds.
8. The Console will display the RESET CONSOLE option.
9. Push ENTER.

**NOTICE:** With a reset of the Console, all User Profile settings and previous Workouts will be erased from the Console. This information is not retrievable after a reset.

10. The Console will display ARE YOU SURE – NO. Push the Burn Rate/Increase button to change to the ARE YOU SURE – YES option.
11. Push ENTER.

The Console will reset to factory settings, and will display the Power-Up Mode screen.

**NOTICE:** This document provides information to sync the Bowflex Max Trainer® M5 machine to a Bluetooth® enabled device.

**If you need assistance, please call Bowflex Customer Service at 1-800-605-3369.**



**This icon means a potentially hazardous situation which, if not avoided, could result in death or serious injury. Read and understand all Warnings on this machine.**

Nautilus, Inc., (800) NAUTILUS / (800) 628-8458, www.NautilusInc.com - Customer Service: North America (800) 605-3369, csnl@nautilus.com | outside U.S. www.nautilusinternational.com | Printed in China | © 2016 Nautilus, Inc. | ® indicates trademarks registered in the United States. These marks may be registered in other nations or otherwise protected by common law. Bowflex, the B logo, and Bowflex Max Trainer are trademarks owned by or licensed to Nautilus, Inc. The Bluetooth® word mark and logos are registered trademarks owned by Bluetooth SIG, Inc., and any use of such marks by Nautilus, Inc. is under license.

---

### **Important Safety Instructions - Before servicing or using this equipment, obey the following warnings:**



**This icon means a potentially hazardous situation which, if not avoided, could result in death or serious injury. Read and understand all Warnings on this machine.**

- Read and understand the Part Replacement Procedure before working on the machine. Failure to obey the instructions and safety warnings could cause injury to the service technician or bystanders.
- Keep bystanders and children away from the product being serviced at all times.
- Make sure that the repair is done in an appropriate work space away from foot traffic and exposure to bystanders.
- Some components of the equipment can be heavy or awkward. Enlist the service of a second person when you do maintenance steps involving these components. Do not try to do heavy or awkward steps on your own.
- If replacement parts are necessary, use only genuine Nautilus replacement parts and hardware. Failure to use genuine replacement parts can cause a risk to users, keep the machine from operating correctly and will void the warranty.
- Be sure that all warning stickers and instructional placards applied to the product stay present and in good condition when doing maintenance or replacing components. If necessary request replacement warning stickers or placards from Nautilus customer service.
- Do not try to change the design or functionality of the machine being serviced as this can adversely effect user safety and will void the warranty.
- Do not use the machine until all shrouds, instructions, warning labels and correct functionality have been verified and tested for correct performance.

1. Enable the Bluetooth® wireless feature on your smart device.
2. Turn on the Bowflex Max Trainer® fitness machine.
3. After the initial start-up, the fitness machine will sync with the Bluetooth® enabled device and activate the Bluetooth® synced indicator light. If the machine does not sync, de-activate and re-activate the Bluetooth® wireless feature on your smart device. Then click on the “Sync to Machine” button from within the App. When synced, the indicator light will activate.

**Note:** If the Bluetooth® synced indicator light is active and your Bluetooth® enabled device is not synced, the fitness machine may have synced to another Bluetooth® enabled device. Turn the power off to the machine, wait 5 minutes, and restart it with your smart device near the fitness machine.

**Note:** Only machines built after December 2016 include a synced indicator light.

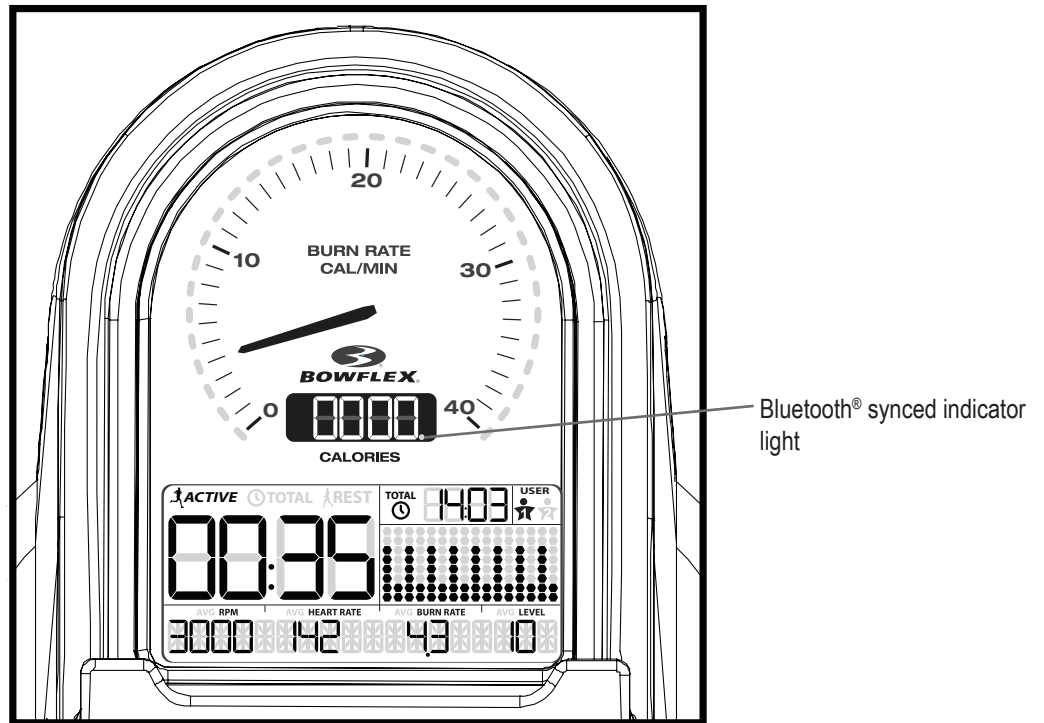

**NOTICE:** This document provides instructions for the replacement of the AC Inlet on the Bowflex Max Trainer® M3 / M5.

If you need assistance, please call Bowflex Customer Service at 1-800-605-3369.

 This icon means a potentially hazardous situation which, if not avoided, could result in death or serious injury. Read and understand all Warnings on this machine.

Nautilus, Inc., (800) NAUTILUS / (800) 628-8458, www.NautilusInc.com - Customer Service: North America (800) 605-3369, csnls@nautilus.com | outside U.S. www.nautilusinternational.com | Printed in China | © 2014 Nautilus, Inc. | ® indicates trademarks registered in the United States. These marks may be registered in other nations or otherwise protected by common law. Bowflex, the B logo, and Bowflex Max Trainer are trademarks owned by or licensed to Nautilus, Inc.

### Important Safety Instructions - Before servicing or using this equipment, obey the following warnings:

 This icon means a potentially hazardous situation which, if not avoided, could result in death or serious injury. Read and understand all Warnings on this machine.

- Read and understand the Part Replacement Procedure before working on the machine. Failure to obey the instructions and safety warnings could cause injury to the service technician or bystanders.
- Keep bystanders and children away from the product being serviced at all times.
- Make sure that the repair is done in an appropriate work space away from foot traffic and exposure to bystanders.
- Disconnect all power and allow to sit for 5 minutes before you service this machine.
- Some components of the equipment can be heavy or awkward. Enlist the service of a second person when you do maintenance steps involving these components. Do not try to do heavy or awkward steps on your own.
- If replacement parts are necessary, use only genuine Nautilus replacement parts and hardware. Failure to use genuine replacement parts can cause a risk to users, keep the machine from operating correctly and will void the warranty.
- Be sure that all warning stickers and instructional placards applied to the product stay present and in good condition when doing maintenance or replacing components. If necessary request replacement warning stickers or placards from Nautilus customer service.
- Do not try to change the design or functionality of the machine being serviced as this can adversely effect user safety and will void the warranty.
- Do not use the machine until all shrouds, instructions, warning labels and correct functionality have been verified and tested for correct performance.

### Tools Required (not included)

#2 Phillips screwdriver

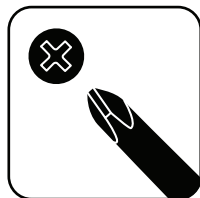

5mm hex wrench



15mm wrench



**Note:** The Bowflex Max Trainer® M3 is used in the following images. The procedure is the same for the M5 model.

1. Unplug the AC Adapter from the machine and wait 5 minutes.

2. Using a #2 Phillips screwdriver, remove the indicated (by ovals) screws and only loosen the lowest indicated screw (arrow) from the Right Fan Cover.

**Note:** Loosen the lowest screw by at least 3 full rotations.

3. The Right Fan Cover has a tab that needs to be pushed upward to clear the loosened screw. While pushing up on the tab, remove the Right Fan Cover from the assembly.

**Note:** the AC Power Cable is attached to the inside of the Right Fan Cover. Be sure not to crimp the cable by placing the Right Fan Cover close to the front of the machine.

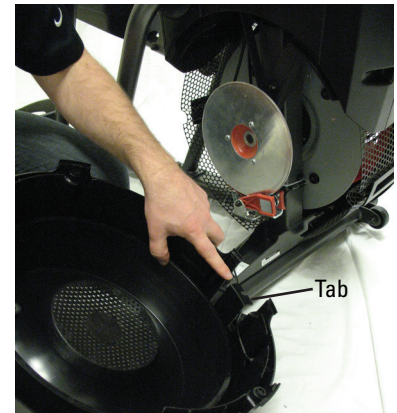
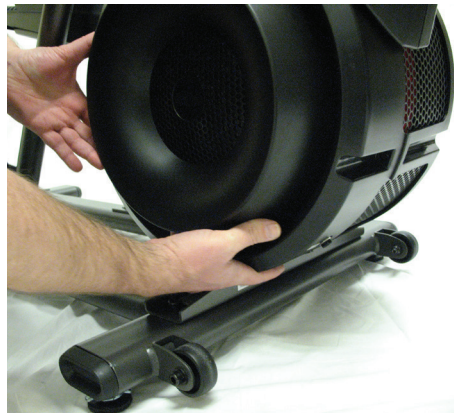

4. Using a 15mm open face wrench, remove the Securing Ring from the outside of the Right Fan Cover.

5. Remove the AC Inlet from the inside of the Right Fan Cover.

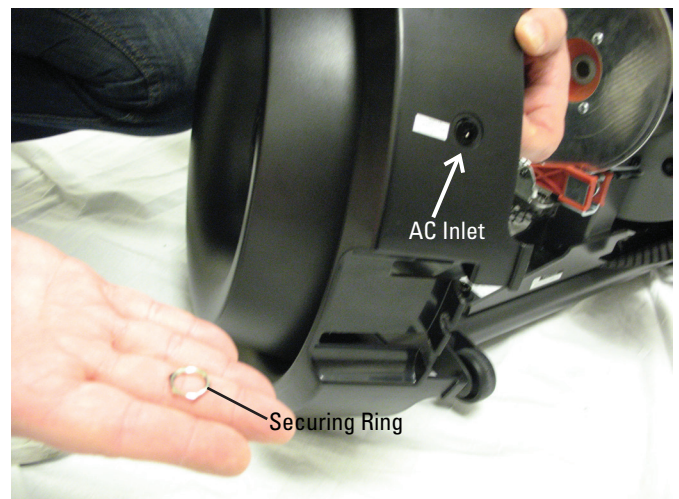

6. Disconnect the AC Inlet from the Power Connector.

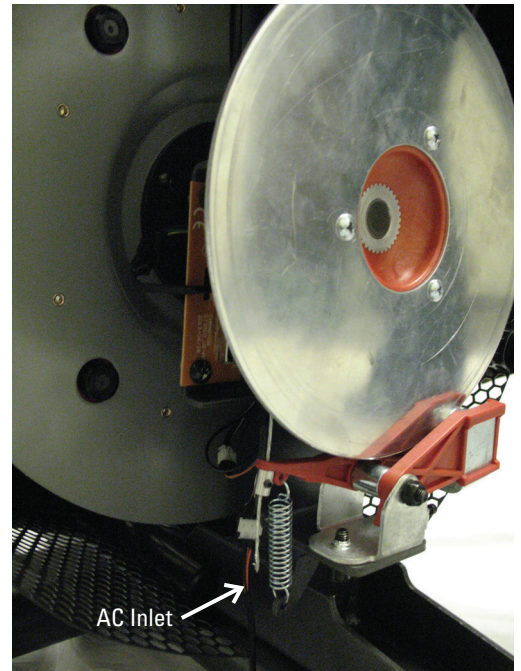

7. Installation is the reverse procedure.

#### 8. Final Inspection

Inspect your machine to ensure that all hardware is tight and components are properly assembled.



**Do not use until the machine has been fully assembled and inspected for correct performance in accordance with the Owner's Manual.**

**NOTICE:** This document provides instructions for the replacement of the Brake Assembly on the Bowflex Max Trainer® M3 / M5.

**If you need assistance, please call Bowflex Customer Service at 1-800-605-3369.**

 **This icon means a potentially hazardous situation which, if not avoided, could result in death or serious injury. Read and understand all Warnings on this machine.**

Nautilus, Inc., (800) 605-3369, www.NautilusInc.com - Customer Service: North America (800) 605-3369, csnlcs@nautilus.com | outside U.S. www.nautilusinternational.com | Printed in China | © 2014 Nautilus, Inc. | ® indicates trademarks registered in the United States. These marks may be registered in other nations or otherwise protected by common law. Bowflex, the B logo, and Bowflex Max Trainer are trademarks owned by or licensed to Nautilus, Inc.

### Important Safety Instructions - Before servicing or using this equipment, obey the following warnings:

 **This icon means a potentially hazardous situation which, if not avoided, could result in death or serious injury. Read and understand all Warnings on this machine.**

- Read and understand the Part Replacement Procedure before working on the machine. Failure to obey the instructions and safety warnings could cause injury to the service technician or bystanders.
- Keep bystanders and children away from the product being serviced at all times.
- Make sure that the repair is done in an appropriate work space away from foot traffic and exposure to bystanders.
- Disconnect all power and allow to sit for 5 minutes before you service this machine.
- Some components of the equipment can be heavy or awkward. Enlist the service of a second person when you do maintenance steps involving these components. Do not try to do heavy or awkward steps on your own.
- If replacement parts are necessary, use only genuine Nautilus replacement parts and hardware. Failure to use genuine replacement parts can cause a risk to users, keep the machine from operating correctly and will void the warranty.
- Be sure that all warning stickers and instructional placards applied to the product stay present and in good condition when doing maintenance or replacing components. If necessary request replacement warning stickers or placards from Nautilus customer service.
- Do not try to change the design or functionality of the machine being serviced as this can adversely effect user safety and will void the warranty.
- Do not use the machine until all shrouds, instructions, warning labels and correct functionality have been verified and tested for correct performance.

### Tools Required (not included)

#2 Phillips screwdriver



8mm wrench  
10mm wrench

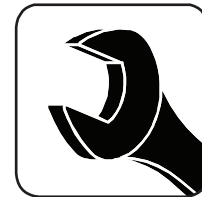

1.5mm hex wrench  
10mm hex wrench



Tape, any type (only used as a place holder)



**Note:** The Bowflex Max Trainer® M3 is used in the following images. The adjustment procedure is the same for the M5 model.

1. With power supplied to the machine, adjust the resistance to the maximum setting.

2. Unplug the AC Adapter from the machine and wait 5 minutes.

3. Using a #2 Phillips screwdriver, remove the indicated (by ovals) screws and only loosen the lowest indicated screw (arrow) from the Right Fan Cover.

**Note:** Loosen the lowest screw by at least 3 full rotations.

4. The Right Fan Cover has a tab that needs to be pushed upward to clear the loosened screw. While pushing up on the tab, remove the Right Fan Cover from the assembly.

**Note:** the AC Power Cable is attached to the inside of the Right Fan Cover. Be sure not to crimp the cable by placing the Right Fan Cover close to the front of the machine.

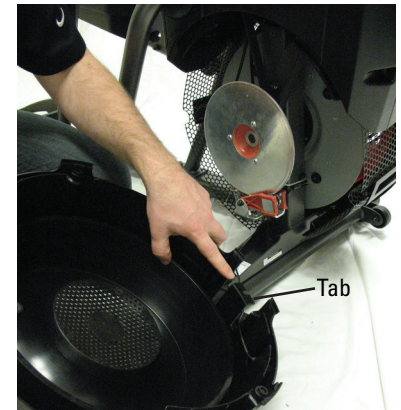
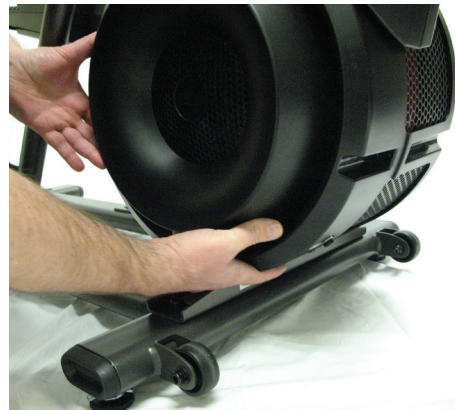

5. Place a piece of tape on the Brake Cable immediately above the Brake Arm. During re-assembly, the tape will be a guide for the placement of the new Brake Arm on the Brake Cable.

6. While applying upward pressure to the Brake Arm, remove the hardware that secures the Brake Cable to the Brake Arm with a 1.5mm hex wrench. Once loose, gradually lower the Brake Arm.

**Note:** Be aware that the Spring will pull the Brake Arm once released. An object can be placed under the Brake Arm to supply resistance during the release of the Brake Cable Hardware.

7. Remove the Brake Spring from the Brake Arm.

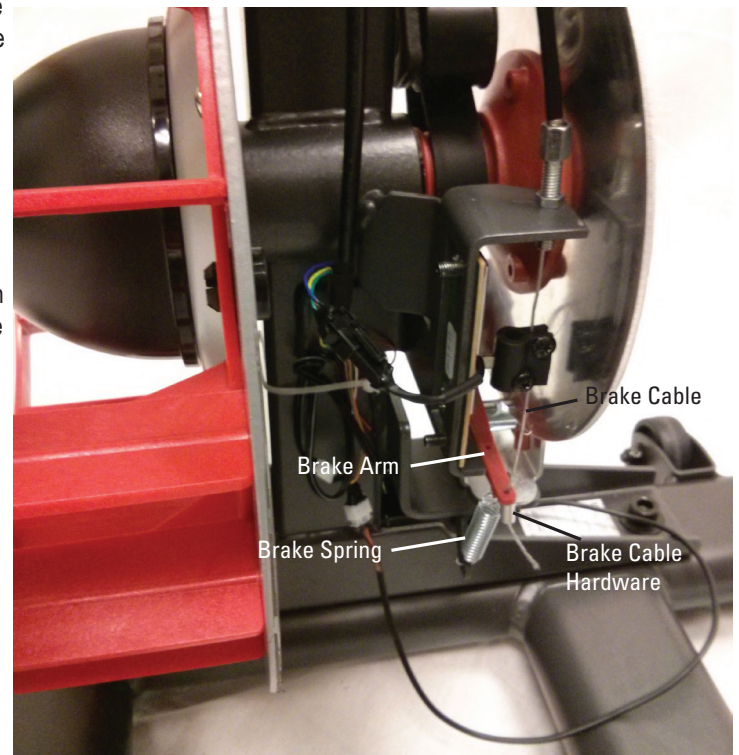



8. Using a 10mm hex wrench, remove the indicated screws (by arrows) that connect the Brake Assembly and remove it.

9. Attach the new Brake Assembly, but do not fully tighten the hardware.

10. Attach the Brake Disc.

11. Reattach the Brake Spring and the Brake Cable to the Brake Arm, and adjust to the tape marker.

12. At the maximum resistance setting, the outer edge of the Brake Magnet should line up with the outer edge of the Brake Disc.

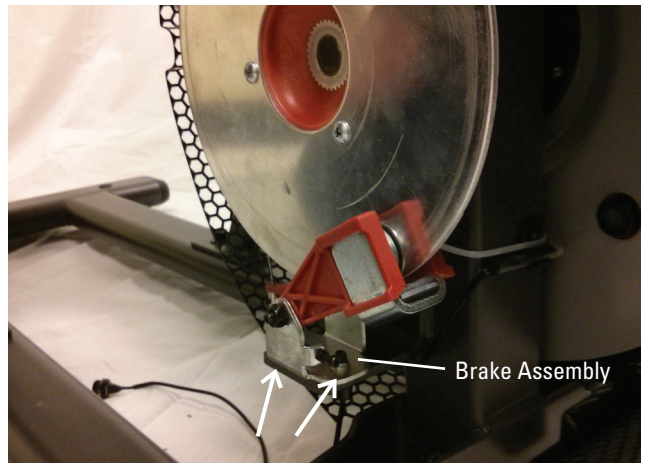
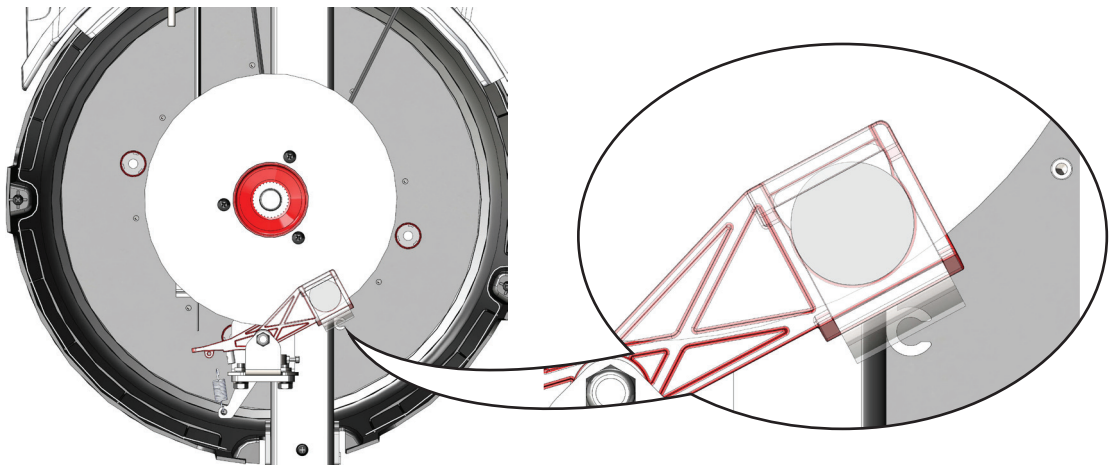

13. If the Brake Assembly needs to be adjusted, use a 8mm open ended wrench to loosen the Brake Cable Securing Nut. Turn the Adjustment Barrel by hand until the magnet is placed correctly.

14. Carefully rotate the Brake Disc. If the Brake Disc does not rub against the Brake Magnet, skip to step 17.

 **Keep fingers out of any pinch opportunities when rotating the Brake Disc.**

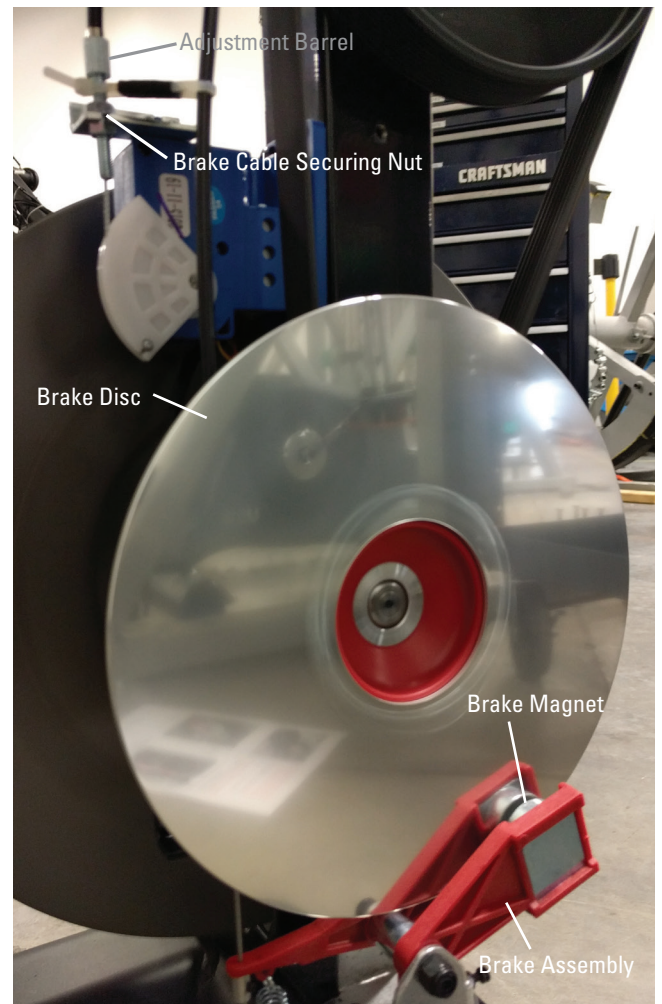

15. The Brake Magnets should be aligned with the Brake Disc and centered around the Brake Disc.

16. If the Brake Assembly only needs to be slightly adjusted, loosen the front screw that secures the Brake Assembly using a 10mm hex wrench. Rotate the Brake Assembly until the Magnets are aligned and of equal distance from the Brake Disc.

If the Brake Assembly must be fully shifted, loosen the 2 screws that secure the assembly and shift it until centered and aligned with the Brake Disc. Fully tighten the hardware.

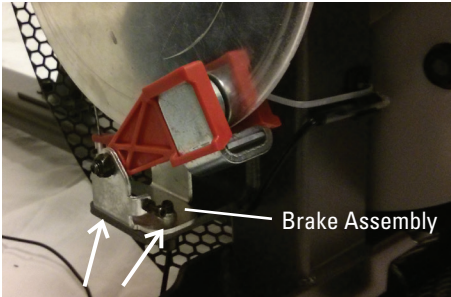

Rotate the Brake Disc to be sure it does not make contact with the magnets. If further adjustment is needed, repeat step 15.

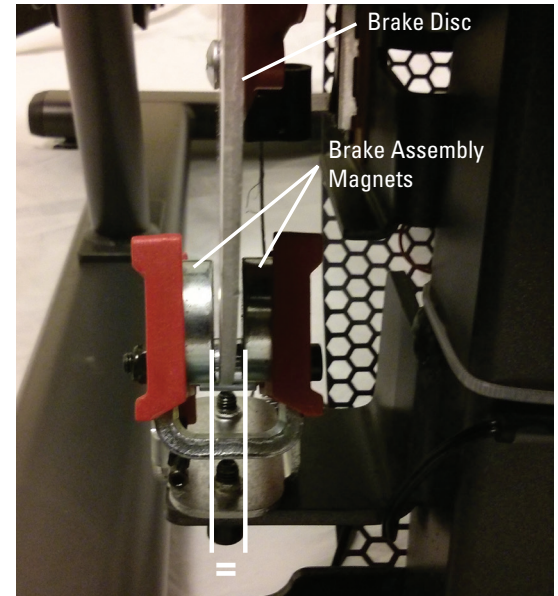

17. Installation is the reverse procedure.

#### 18. Final Inspection

Inspect your machine to ensure that all hardware is tight and components are properly assembled.



**Do not use until the machine has been fully assembled and inspected for correct performance in accordance with the Owner's Manual.**

**NOTICE:** This document provides instructions for the replacement of the Console Assembly on the Bowflex Max Trainer® M3 / M5.

**If you need assistance, please call Bowflex Customer Service at 1-800-605-3369.**

 **This icon means a potentially hazardous situation which, if not avoided, could result in death or serious injury. Read and understand all Warnings on this machine.**

Nautilus, Inc., (800) NAUTILUS / (800) 628-8458, www.NautilusInc.com - Customer Service: North America (800) 605-3369, csnls@nautilus.com | outside U.S. www.nautilusinternational.com | Printed in China | © 2014 Nautilus, Inc. | ® indicates trademarks registered in the United States. These marks may be registered in other nations or otherwise protected by common law. Bowflex, the B logo, and Bowflex Max Trainer are trademarks owned by or licensed to Nautilus, Inc.

### Important Safety Instructions - Before servicing or using this equipment, obey the following warnings:

 **This icon means a potentially hazardous situation which, if not avoided, could result in death or serious injury. Read and understand all Warnings on this machine.**

- Read and understand the Part Replacement Procedure before working on the machine. Failure to obey the instructions and safety warnings could cause injury to the service technician or bystanders.
- Keep bystanders and children away from the product being serviced at all times.
- Make sure that the repair is done in an appropriate work space away from foot traffic and exposure to bystanders.
- Disconnect all power and allow to sit for 5 minutes before you service this machine.
- Some components of the equipment can be heavy or awkward. Enlist the service of a second person when you do maintenance steps involving these components. Do not try to do heavy or awkward steps on your own.
- If replacement parts are necessary, use only genuine Nautilus replacement parts and hardware. Failure to use genuine replacement parts can cause a risk to users, keep the machine from operating correctly and will void the warranty.
- Be sure that all warning stickers and instructional placards applied to the product stay present and in good condition when doing maintenance or replacing components. If necessary request replacement warning stickers or placards from Nautilus customer service.
- Do not try to change the design or functionality of the machine being serviced as this can adversely effect user safety and will void the warranty.
- Do not use the machine until all shrouds, instructions, warning labels and correct functionality have been verified and tested for correct performance.

### Tools Required (not included)

#2 Phillips screwdriver

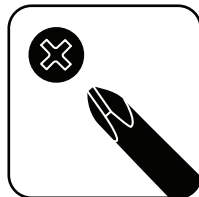

**Note:** The Bowflex Max Trainer® M3 is used in the following images. The procedure is the same for the M5 model.

1. Unplug the AC Adapter from the machine and wait 5 minutes.

2. Using a #2 Phillips screwdriver, remove the 4 screws (2 on each side of the Shroud) from the Console Assembly.



3. Carefully lift the Console Assembly and expose the Cable Connections.  
**Note:** do not crimp any of the Console Cables.



4. Carefully disconnect the Cables noting their locations (see arrows).  
**Note:** do not crimp any of the Console Cables.

5. Installation is the reverse procedure.

6. Final Inspection  
Inspect your machine to ensure that all hardware is tight and components are properly assembled.



**Do not use until the machine has been fully assembled and inspected for correct performance in accordance with the Owner's Manual.**

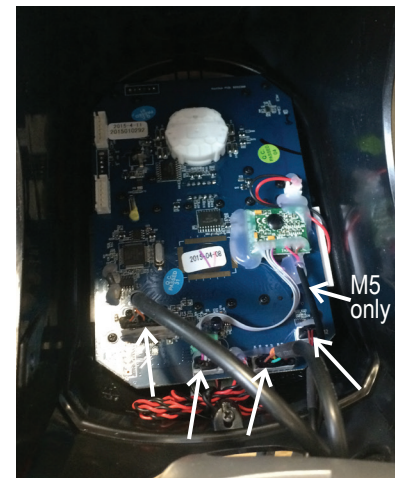

**NOTICE:** This document provides instructions for the replacement of the Console Assembly on the Bowflex Max Trainer® M3 / M5.

**If you need assistance, please call Bowflex Customer Service at 1-800-605-3369.**

 **This icon means a potentially hazardous situation which, if not avoided, could result in death or serious injury. Read and understand all Warnings on this machine.**

Nautilus, Inc., (800) NAUTILUS / (800) 628-8458, www.NautilusInc.com - Customer Service: North America (800) 605-3369, csnls@nautilus.com | outside U.S. www.nautilusinternational.com | Printed in China | © 2014 Nautilus, Inc. | ® indicates trademarks registered in the United States. These marks may be registered in other nations or otherwise protected by common law. Bowflex, the B logo, and Bowflex Max Trainer are trademarks owned by or licensed to Nautilus, Inc.

### Important Safety Instructions - Before servicing or using this equipment, obey the following warnings:

 **This icon means a potentially hazardous situation which, if not avoided, could result in death or serious injury. Read and understand all Warnings on this machine.**

- Read and understand the Part Replacement Procedure before working on the machine. Failure to obey the instructions and safety warnings could cause injury to the service technician or bystanders.
- Keep bystanders and children away from the product being serviced at all times.
- Make sure that the repair is done in an appropriate work space away from foot traffic and exposure to bystanders.
- Disconnect all power and allow to sit for 5 minutes before you service this machine.
- Some components of the equipment can be heavy or awkward. Enlist the service of a second person when you do maintenance steps involving these components. Do not try to do heavy or awkward steps on your own.
- If replacement parts are necessary, use only genuine Nautilus replacement parts and hardware. Failure to use genuine replacement parts can cause a risk to users, keep the machine from operating correctly and will void the warranty.
- Be sure that all warning stickers and instructional placards applied to the product stay present and in good condition when doing maintenance or replacing components. If necessary request replacement warning stickers or placards from Nautilus customer service.
- Do not try to change the design or functionality of the machine being serviced as this can adversely effect user safety and will void the warranty.
- Do not use the machine until all shrouds, instructions, warning labels and correct functionality have been verified and tested for correct performance.

### Tools Required (not included)

#2 Phillips screwdriver

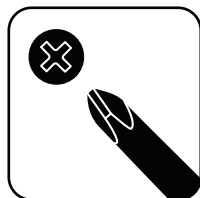

**Note:** The Bowflex Max Trainer® M3 is used in the following images. The procedure is the same for the M5 model.

1. Unplug the AC Adapter from the machine and wait 5 minutes.
2. Using a #2 Phillips screwdriver, remove the 4 screws (2 indicated on each side) from the Console Assembly.



3. Carefully lift the Console Assembly and expose the Cable Connections.  
**Note:** do not crimp any of the Console Cables.



4. Carefully disconnect the Cables noting their locations (see arrows).  
**Note:** do not crimp any of the Console Cables.

5. Using a #2 Phillips screwdriver, remove the indicated screw (see oval) from the rear of the Console Display.

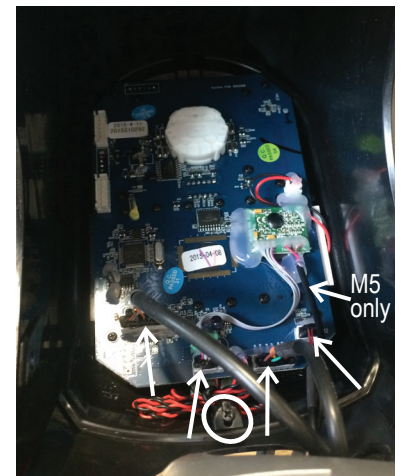

6. Carefully pivot the Console Display from the Console Assembly.

7. Pivot the new Console Display into the Console Assembly.

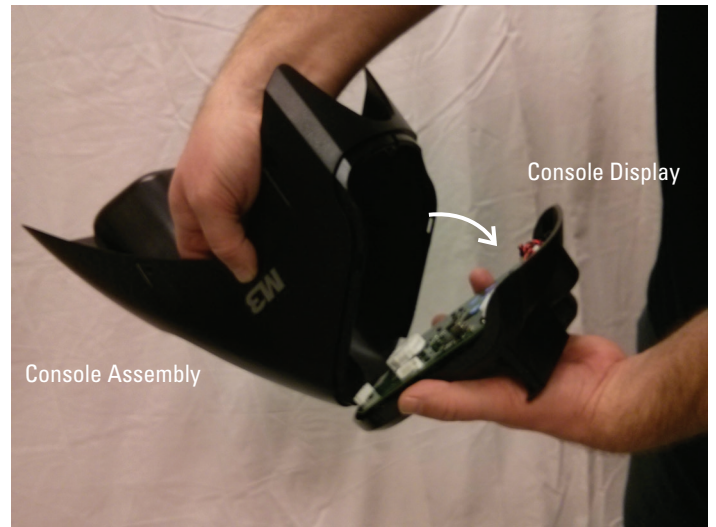

8. Installation is the reverse procedure.

#### 9. Final Inspection

Inspect your machine to ensure that all hardware is tight and components are properly assembled.



**Do not use until the machine has been fully assembled and inspected for correct performance in accordance with the Owner's Manual.**

**NOTICE:** This document provides instructions for the replacement of the Crank Arms on the Bowflex Max Trainer® M3 / M5.

If you need assistance, please call Bowflex Customer Service at 1-800-605-3369.

**!** This icon means a potentially hazardous situation which, if not avoided, could result in death or serious injury. Read and understand all Warnings on this machine.

Nautilus, Inc., (800) NAUTILUS / (800) 628-8458, www.NautilusInc.com - Customer Service: North America (800) 605-3369, csnl@nautilus.com | outside U.S. www.nautilusinternational.com | Printed in China | © 2014 Nautilus, Inc. | ® indicates trademarks registered in the United States. These marks may be registered in other nations or otherwise protected by common law. Bowflex, the B logo, and Bowflex Max Trainer are trademarks owned by or licensed to Nautilus, Inc.

### Important Safety Instructions - Before servicing or using this equipment, obey the following warnings:

**!** This icon means a potentially hazardous situation which, if not avoided, could result in death or serious injury. Read and understand all Warnings on this machine.

- Read and understand the Part Replacement Procedure before working on the machine. Failure to obey the instructions and safety warnings could cause injury to the service technician or bystanders.
- Keep bystanders and children away from the product being serviced at all times.
- Make sure that the repair is done in an appropriate work space away from foot traffic and exposure to bystanders.
- Disconnect all power and allow to sit for 5 minutes before you service this machine.
- Some components of the equipment can be heavy or awkward. Enlist the service of a second person when you do maintenance steps involving these components. Do not try to do heavy or awkward steps on your own.
- If replacement parts are necessary, use only genuine Nautilus replacement parts and hardware. Failure to use genuine replacement parts can cause a risk to users, keep the machine from operating correctly and will void the warranty.
- Be sure that all warning stickers and instructional placards applied to the product stay present and in good condition when doing maintenance or replacing components. If necessary request replacement warning stickers or placards from Nautilus customer service.
- Do not try to change the design or functionality of the machine being serviced as this can adversely effect user safety and will void the warranty.
- Do not use the machine until all shrouds, instructions, warning labels and correct functionality have been verified and tested for correct performance.

### Tools Required (not included)

#2 Phillips screwdriver



16mm wrench



5mm hex wrench  
6mm hex wrench



9/16" or 14mm Socket and Wrench



Crank Puller (non-handled,  
JIS/ISO square taper  
with M22x1.0 threads)

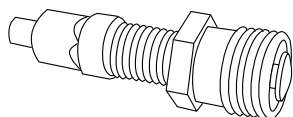



**Note:** The Bowflex Max Trainer® M3 is used in the following images. The procedure is the same for the M5 model.

1. From the side with the Crank Arm that needs to be replaced, remove the indicated Cap.

**Note:** The following photos show the removal of the Left Crank Arm.

2. Using a 6mm hex wrench, remove the hardware exposed from below the Cap.

3. Lift the Foot Pedal and slide the Leg Assembly straight off the machine. Be sure to pull straight out, or the Leg Assembly may be difficult to remove.

**Note:** A rubber mallet may be necessary if the Leg Assembly will not slide off.

4. Using a 5mm hex wrench, remove the indicated hardware from the Upper Handlebar.

**Note:** Be aware that the Upper Handlebar must be supported when removing the hardware.

5. Using a #2 Phillips screwdriver, remove the 2 indicated screws from the Crank Cover.

**Note:** The image displays the Right Crank Cover being removed.

6. Remove the Crank Cover from the machine.

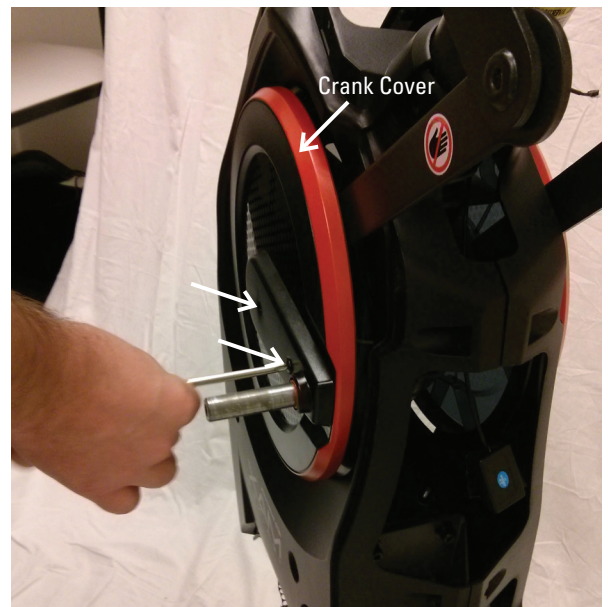

7. Place a rag or protective material below the Connector Arm to protect the Shrouds from potential scratches from the Connector Arms.

8. Using a 6mm hex wrench, remove the hardware that connects the Connector Arms and the Pivot Arms.

**Note:** The Connector Arm will pivot downward if not lowered slowly onto the rag protecting the Shrouds.

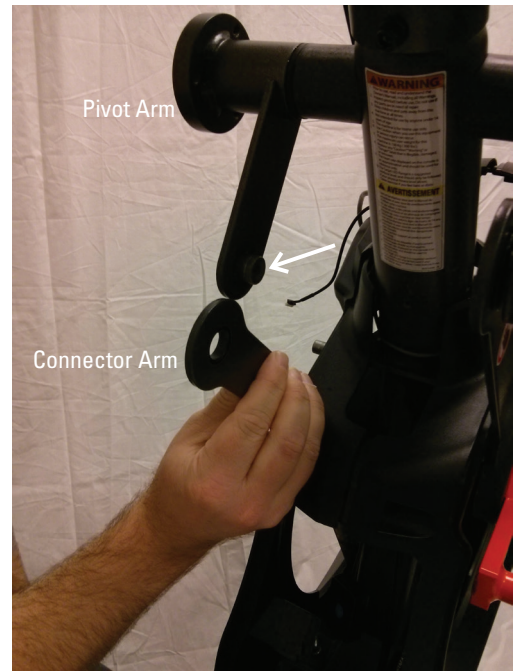

9. Using a 9/16" or 14mm socket and wrench, remove the nut from the Crank Assembly.



10. Adjust the Crank Puller until the end of the Bolt is flush with the Nut (as shown).



11. Carefully thread the Crank Puller into the Crank Arm. Be sure the Crank Puller has at least three rounds of threads inserted.

12. Using a 16mm wrench, turn the inner portion (the Bolt) of the Crank Puller clockwise. The Crank Arm will slide off as it is tightened.

**Note:** Be aware that the Crank Arm will be loose and will need to be supported.

13. Remove the Crank Puller from the Crank Arm.

14. If necessary, repeat the procedure to remove the other Crank Arm.

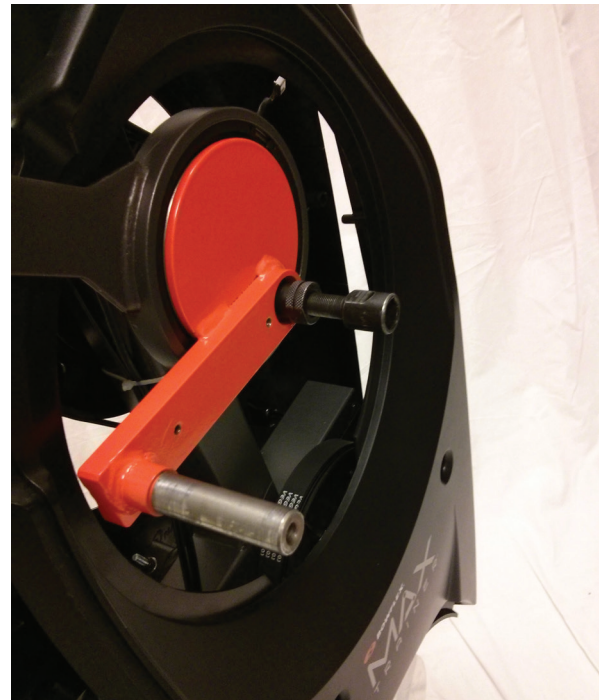

15. Installation is the reverse procedure excluding steps with the Crank Puller. The Crank Puller is not required for re-assembly.

**Note:** When replacing the Crank Arm be sure the Right and Left Crank Arms are oriented inline and opposite each other.

The Crank Nut should be tightened to a torque value of 29-32.5 ft lbs (or 350-390 in lbs).

16. Final Inspection

Inspect your machine to ensure that all hardware is tight and components are properly assembled.

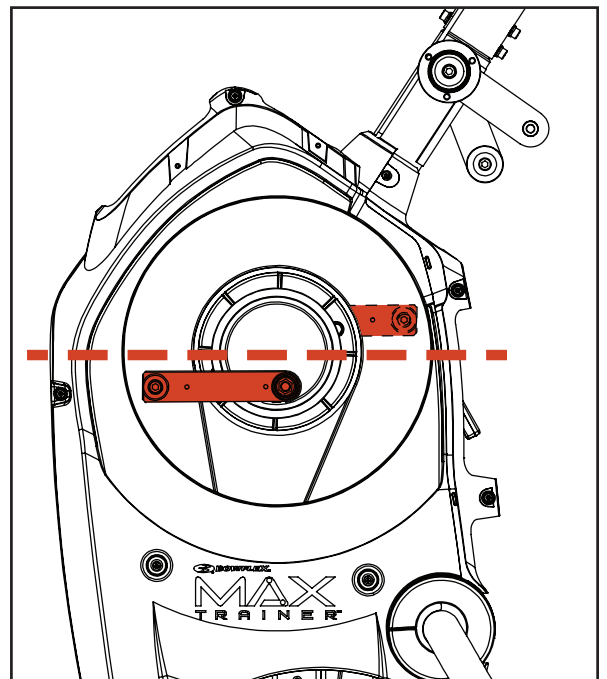

**Do not use until the machine has been fully assembled and inspected for correct performance in accordance with the Owner's Manual.**

**NOTICE:** This document provides instructions for the replacement of the Drive Belt on the Bowflex Max Trainer® M3 / M5.

**If you need assistance, please call Bowflex Customer Service at 1-800-605-3369.**

 **This icon means a potentially hazardous situation which, if not avoided, could result in death or serious injury. Read and understand all Warnings on this machine.**

Nautilus, Inc., (800) 605-3369, www.NautilusInc.com - Customer Service: North America (800) 605-3369, csNls@nautilus.com | outside U.S. www.nautilusinternational.com | Printed in China | © 2014 Nautilus, Inc. | ® indicates trademarks registered in the United States. These marks may be registered in other nations or otherwise protected by common law. Bowflex, the B logo, and Bowflex Max Trainer are trademarks owned by or licensed to Nautilus, Inc.

### Important Safety Instructions - Before servicing or using this equipment, obey the following warnings:

 **This icon means a potentially hazardous situation which, if not avoided, could result in death or serious injury. Read and understand all Warnings on this machine.**

- Read and understand the Part Replacement Procedure before working on the machine. Failure to obey the instructions and safety warnings could cause injury to the service technician or bystanders.
- Keep bystanders and children away from the product being serviced at all times.
- Make sure that the repair is done in an appropriate work space away from foot traffic and exposure to bystanders.
- Disconnect all power to the machine before you service it.
- Some components of the equipment can be heavy or awkward. Enlist the service of a second person when you do maintenance steps involving these components. Do not try to do heavy or awkward steps on your own.
- If replacement parts are necessary, use only genuine Nautilus replacement parts and hardware. Failure to use genuine replacement parts can cause a risk to users, keep the machine from operating correctly and will void the warranty.
- Be sure that all warning stickers and instructional placards applied to the product stay present and in good condition when doing maintenance or replacing components. If necessary request replacement warning stickers or placards from Nautilus customer service.
- Do not try to change the design or functionality of the machine being serviced as this can adversely effect user safety and will void the warranty.
- Do not use the machine until all shrouds, instructions, warning labels and correct functionality have been verified and tested for correct performance.

### Tools Required (not included)

#2 Phillips screwdriver

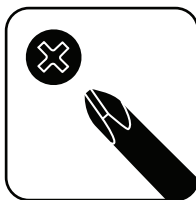

#2 Standard screwdriver



4mm hex wrench  
5mm hex wrench  
6mm hex wrench  
8mm hex wrench



**Note:** The Bowflex Max Trainer® M3 is used in the following images. The procedure is the same for the M5 model.

1. Unplug the AC Adapter from the wall outlet and machine.
2. Using a #2 Phillips screwdriver, remove the 4 screws (2 indicated on one side) from the Console Assembly.



3. Carefully lift the Console Assembly and expose the Cable Connections.



4. Carefully disconnect the Cables noting their locations.

**Note:** do not crimp any of the Console Cables.

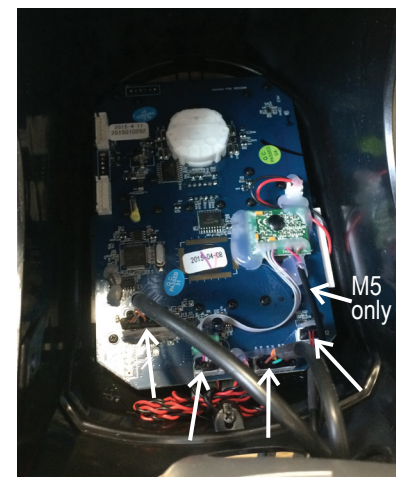

5. Using a 5mm hex wrench, remove the indicated hardware from the Upper Handlebars.

**Note:** Be aware that the Upper Handlebars must be supported when removing the hardware.



6. Using a #2 Phillips screwdriver, remove the indicated (by ovals) screws and only loosen the lowest indicated screw (arrow) from the Right Fan Cover.



7. The Right Fan Cover has a tab that needs to be pushed upward to clear the loosened screw. While pushing up on the tab, remove the Right Fan Cover from the assembly.

**Note:** the AC Power Cable is attached to the inside of the Right Fan Cover. Be sure not to crimp the cable by placing the Right Fan Cover close to the front of the machine.

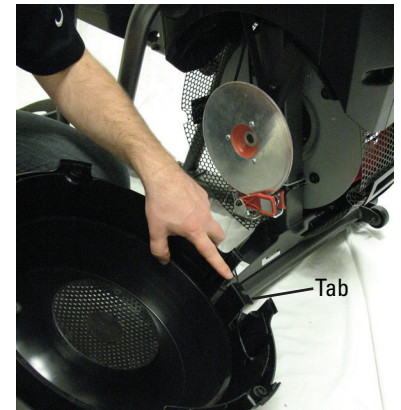
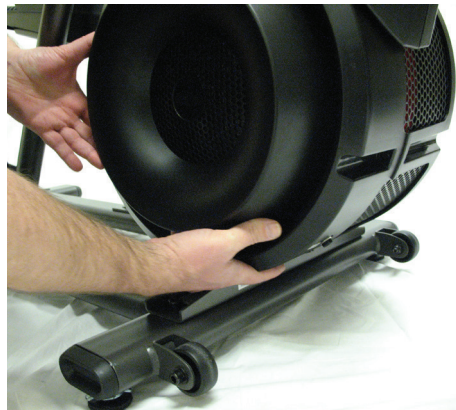

8. Remove the indicated Cap from both sides of the machine.

9. Using a 6mm hex wrench, remove the hardware exposed from below the Cap from both sides of the machine.

10. Slide the Leg Assemblies off of the machine.



11. Using a #2 Phillips screwdriver, remove the indicated screw from the Rear Shroud.

12. Carefully remove the Rear Shroud from the machine. Place a standard screwdriver behind and near the middle of the Rear Shroud and gently pry until it releases. Then move the screwdriver to the bottom and gently pry until the Rear Shroud comes off.

13. Remove the indicated Caps from the machine.

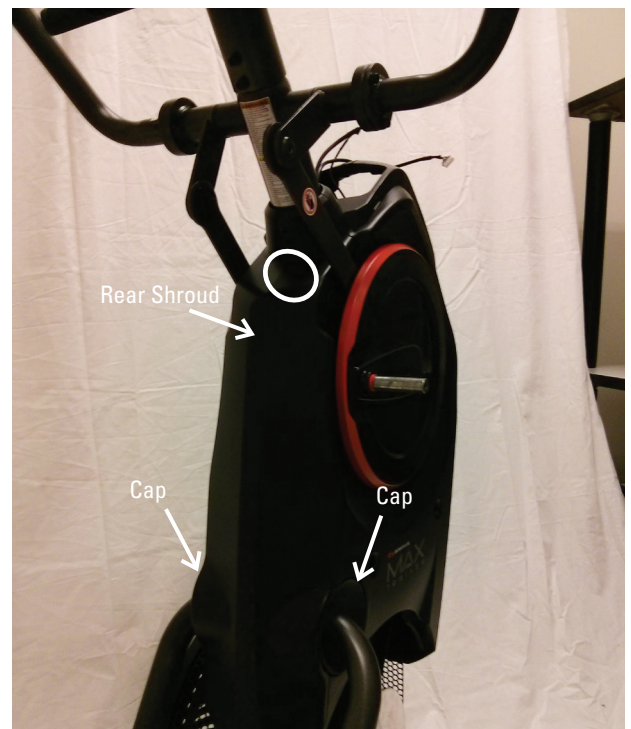

14. Using a #2 Phillips screwdriver, remove the indicated (by ovals) screws and only loosen the lowest indicated screw (arrow) from the Left Fan Cover.

15. The Left Fan Cover Assembly has a tab that needs to be pushed upward to clear the loosened screw. While pushing up on the tab, remove the Left Fan Cover Assembly.

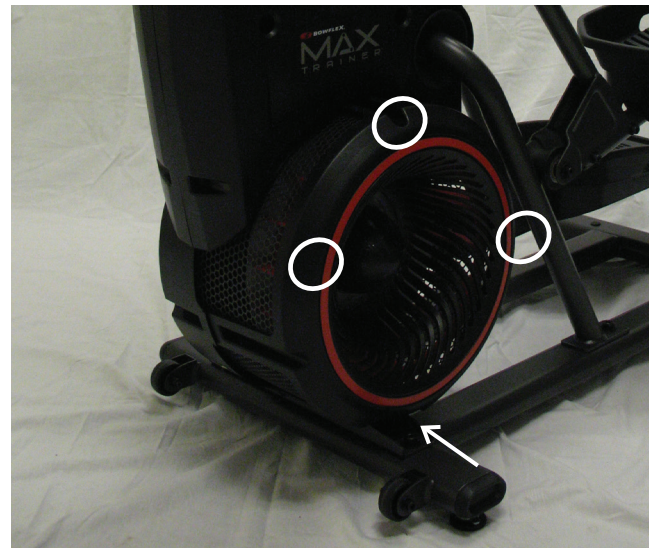

16. Remove the Left Fan Cover Assembly from the machine. Be sure to note how the fan screens are set into the Left Fan Cover to assist with the replacement procedure.



17. Using a #2 Phillips screwdriver, remove the 2 indicated screws from the Crank Cover. Repeat on the other side of the machine.

18. Remove the Crank Covers from the machine.



19. Place a rag or protective material below the Connector Arm to protect the Shrouds from potential scratches from the Connector Arms.

20. Using a 6mm hex wrench, remove the hardware that connects the Connector Arms and the Pivot Arms.

**Note:** The Connector Arm will pivot downward if not lowered slowly onto the rag protecting the Shrouds

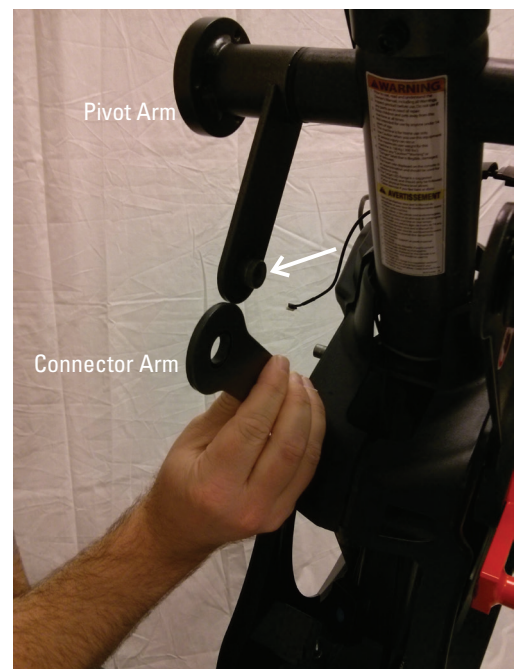



21. Using a #2 Phillips screwdriver, remove the screws from the Left Shroud. ( 9 screws on the Left Shroud) Remove the upper screws labeled ' \* ' last.

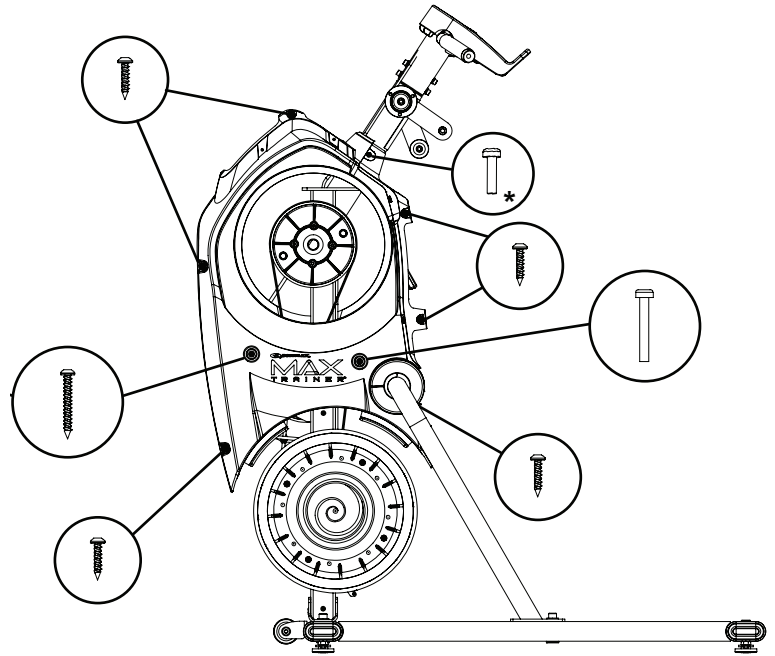

Left Side

**Note:** Shrouds are removed for clarity. To assist with re-assembly, note the orientation of the Drive Pulley before removal.

22. Using a 4mm hex wrench, remove the screw indicated by "A" from the Drive Belt Tensioner Arm.

23. Using a 8mm hex wrench, loosen the screw indicated by "B" until the Drive Belt is free enough to be removed from the Drive Pulley. Remove the Drive Belt.

 **Keep fingers out of any pinch opportunities when removing the Fan Belt.**

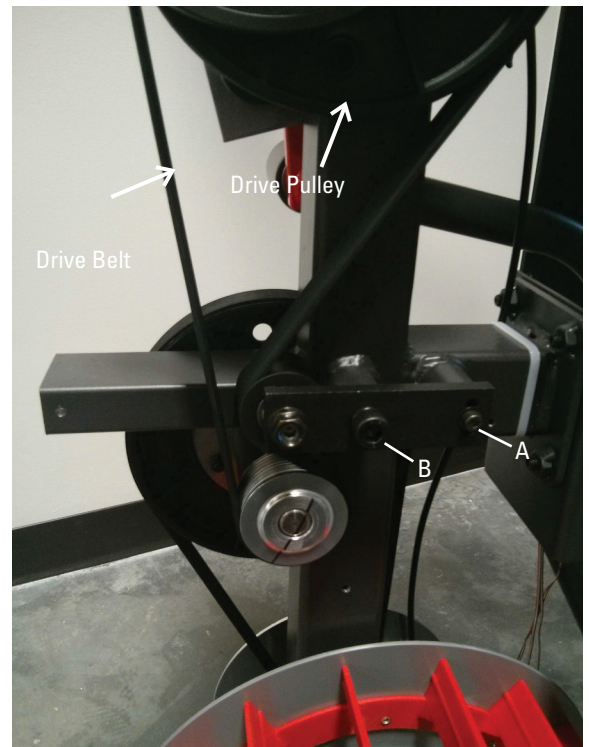

24. Route the new Drive Belt around the Drive Pulley. Be sure the Drive Belt is still in place around the lower pulleys.

25. Replace and tighten the "A" screw on the Drive Belt Tensioner Arm, and then tighten the "B" screw.

26. Installation is the reverse procedure.

27. Final Inspection

Inspect your machine to ensure that all hardware is tight and components are properly assembled.

 **Do not use until the machine has been fully assembled and inspected for correct performance in accordance with the Owner's Manual.**

**NOTICE:** This document provides instructions for the replacement of the Drive Pulley on the Bowflex Max Trainer® M3 / M5.

**If you need assistance, please call Bowflex Customer Service at 1-800-605-3369.**

**This icon means a potentially hazardous situation which, if not avoided, could result in death or serious injury. Read and understand all Warnings on this machine.**

Nautilus, Inc., (800) NAUTILUS / (800) 628-8458, www.NautilusInc.com - Customer Service: North America (800) 605-3369, csnl@snautilus.com | outside U.S. www.nautilusinternational.com | Printed in China | © 2014 Nautilus, Inc. | ® indicates trademarks registered in the United States. These marks may be registered in other nations or otherwise protected by common law. Bowflex, the B logo, and Bowflex Max Trainer are trademarks owned by or licensed to Nautilus, Inc.

### Important Safety Instructions - Before servicing or using this equipment, obey the following warnings:

**This icon means a potentially hazardous situation which, if not avoided, could result in death or serious injury. Read and understand all Warnings on this machine.**

- Read and understand the Part Replacement Procedure before working on the machine. Failure to obey the instructions and safety warnings could cause injury to the service technician or bystanders.
- Keep bystanders and children away from the product being serviced at all times.
- Make sure that the repair is done in an appropriate work space away from foot traffic and exposure to bystanders.
- Disconnect all power to the machine before you service it.
- Some components of the equipment can be heavy or awkward. Enlist the service of a second person when you do maintenance steps involving these components. Do not try to do heavy or awkward steps on your own.
- If replacement parts are necessary, use only genuine Nautilus replacement parts and hardware. Failure to use genuine replacement parts can cause a risk to users, keep the machine from operating correctly and will void the warranty.
- Be sure that all warning stickers and instructional placards applied to the product stay present and in good condition when doing maintenance or replacing components. If necessary request replacement warning stickers or placards from Nautilus customer service.
- Do not try to change the design or functionality of the machine being serviced as this can adversely effect user safety and will void the warranty.
- Do not use the machine until all shrouds, instructions, warning labels and correct functionality have been verified and tested for correct performance.

### Tools Required (not included)

#2 Phillips screwdriver



10mm wrench  
16mm wrench

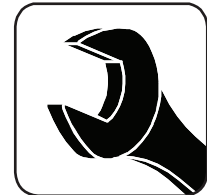

5mm hex wrench  
6mm hex wrench



#2 Standard screwdriver



9/16" or 14mm Socket and Wrench



Crank Puller (non-handled,  
JIS/ISO square taper  
with M22x1.0 threads)

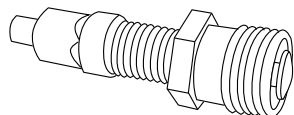

**Note:** The Bowflex Max Trainer® M3 is used in the following images. The procedure is the same for the M5 model.

1. Unplug the AC Adapter from the wall outlet and machine.

2. Using a #2 Phillips screwdriver, remove the 4 screws (2 indicated on one side) from the Console Assembly.



3. Carefully lift the Console Assembly and expose the Cable Connections.



4. Carefully disconnect the Cables noting their locations.

**Note:** do not crimp any of the Console Cables.

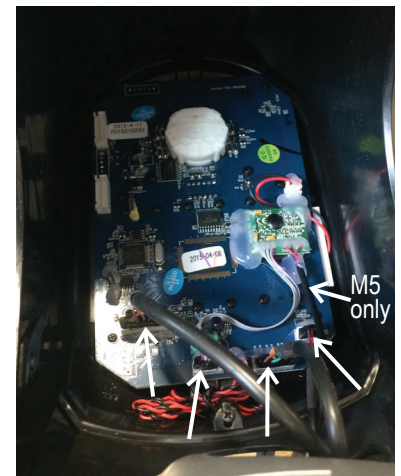

5. Using a 5mm hex wrench, remove the indicated hardware from the Left Upper Handlebar.

**Note:** Be aware that the Upper Handlebar must be supported when removing the hardware.



6. Using a #2 Phillips screwdriver, remove the indicated (by ovals) screws and only loosen the lowest indicated screw (arrow) from the Right Fan Cover.



7. The Right Fan Cover has a tab that needs to be pushed upward to clear the loosened screw. While pushing up on the tab, remove the Right Fan Cover from the assembly.

**Note:** the AC Power Cable is attached to the inside of the Right Fan Cover. Be sure not to crimp the cable by placing the Right Fan Cover close to the front of the machine.

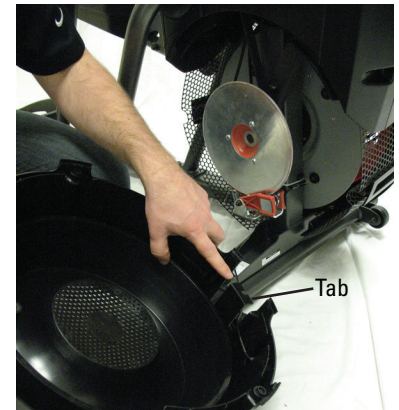
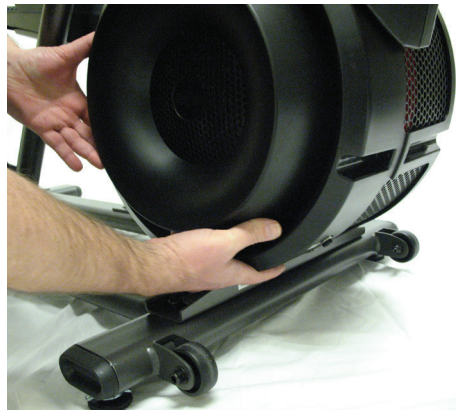

8. Remove the indicated Cap from the machine.

9. Using a 6mm hex wrench, remove the hardware exposed from below the Cap.

10. Slide the Left Leg Assembly off of the machine.



11. Using a #2 Phillips screwdriver, remove the indicated screw from the Rear Shroud.

12. Carefully remove the Rear Shroud from the machine. Place a standard screwdriver behind and near the middle of the Rear Shroud and gently pry until it releases. Then move the screwdriver to the bottom and gently pry until the Rear Shroud comes off.

13. Remove the indicated Caps from the machine.

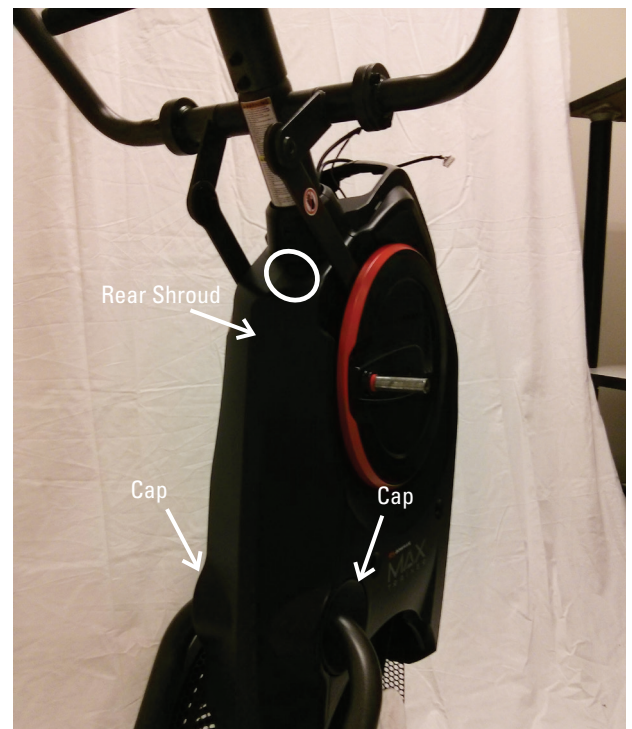

14. Using a #2 Phillips screwdriver, remove the indicated (by ovals) screws and only loosen the lowest indicated screw (arrow) from the Left Fan Cover.

15. The Left Fan Cover Assembly has a tab that needs to be pushed upward to clear the loosened screw. While pushing up on the tab, remove the Left Fan Cover Assembly.

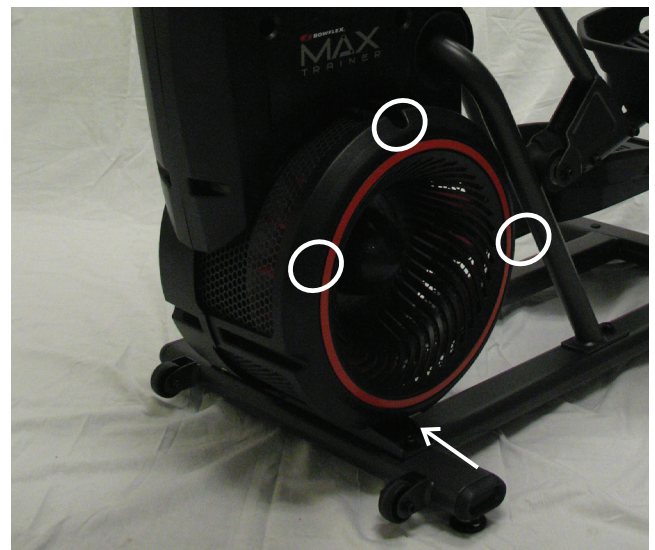

16. Remove the Left Fan Cover Assembly from the machine. Be sure to note how the fan screens are set into the Left Fan Cover to assist with the replacement procedure.

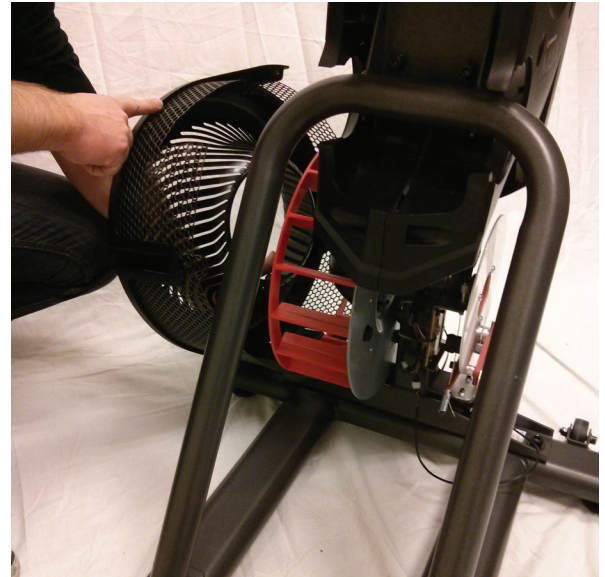

17. Using a #2 Phillips screwdriver, remove the 2 indicated screws from the Left Crank Cover.  
**Note:** The image displays the Right Crank Cover being removed.

18. Remove the Left Crank Cover from the machine.



19. Place a rag or protective material below the Left Connector Arm to protect the Shroud from potential scratches from the Connector Arm.

20. Using a 6mm hex wrench, remove the hardware that connects the Left Connector Arm and the Pivot Arm.

**Note:** The Connector Arm will pivot downward if not lowered slowly onto the rag protecting the Shroud.

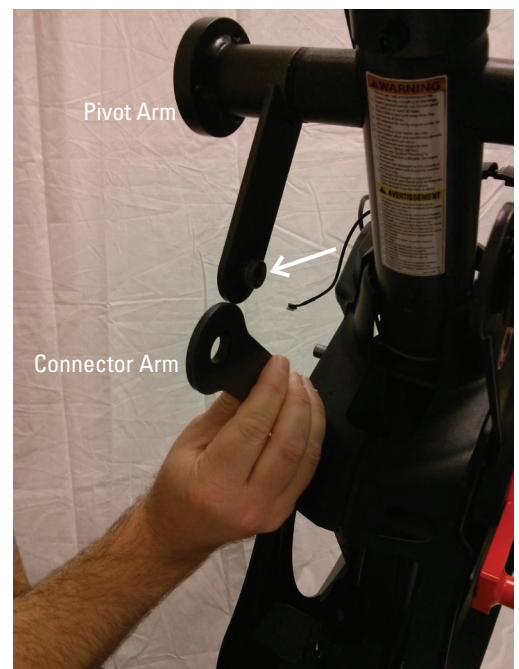

21. Using a 9/16" or 14mm socket and wrench, remove the indicated nut from the Left Crank Assembly.



22. Adjust the Crank Puller until the end of the Bolt is flush with the Nut (as shown).



23. Carefully thread the Crank Puller into the Left Crank Arm. Be sure the Crank Puller has at least three rounds of threads inserted.

24. Using a 16mm wrench, turn the inner portion (the Bolt) of the Crank Puller clockwise. The Left Crank Arm will slide off as it is tightened.

**Note:** Be aware that the Left Crank Arm will be loose and will need to be supported.

25. Remove the Crank Puller from the Left Crank Arm.

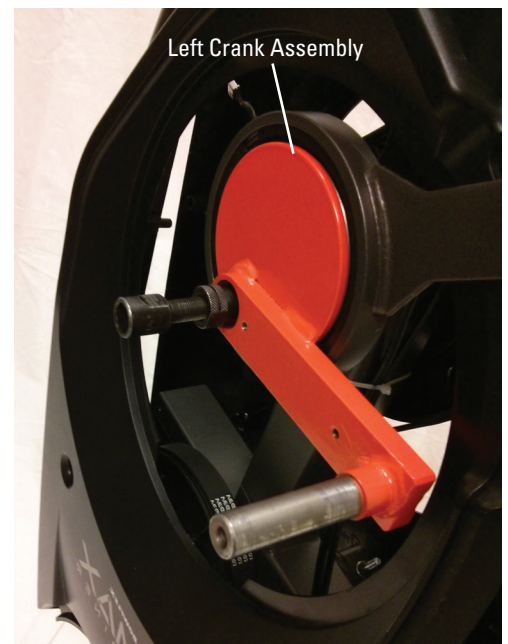

26. Using a #2 Phillips screwdriver, remove the screws from the Left Shroud. ( 9 screws on the Left Shroud) Remove the upper screws labeled ' \* ' last.

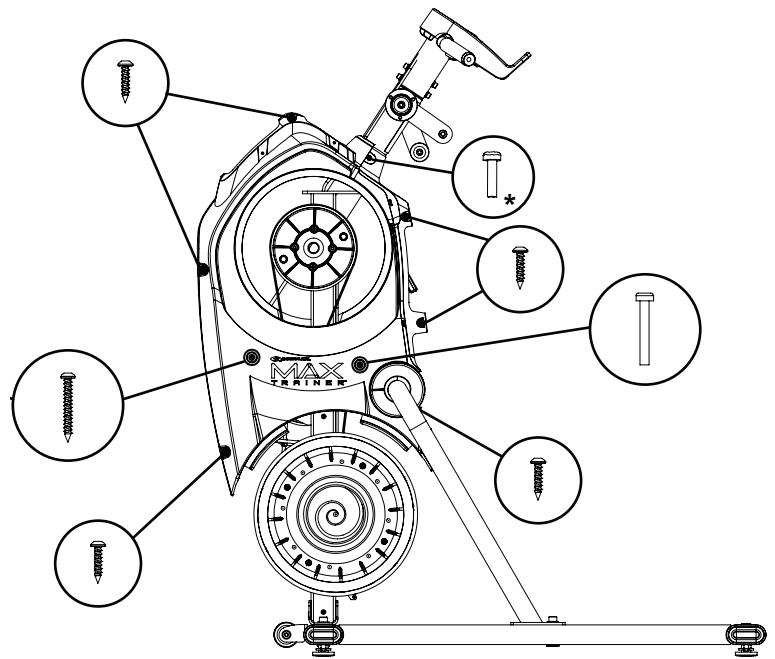

Left Side

**Note:** Shrouds are removed for clarity. To assist with re-assembly, note the orientation of the Drive Pulley before removal.

27. Using a 4mm hex wrench, remove the screw indicated by "A" from the Drive Belt Tensioner Arm.

28. Using a 8mm hex wrench, loosen the screw indicated by "B" until the Drive Belt is free enough to be removed from the Drive Pulley. Remove the Drive Belt.

 **Keep fingers out of any pinch opportunities when removing the Fan Belt.**

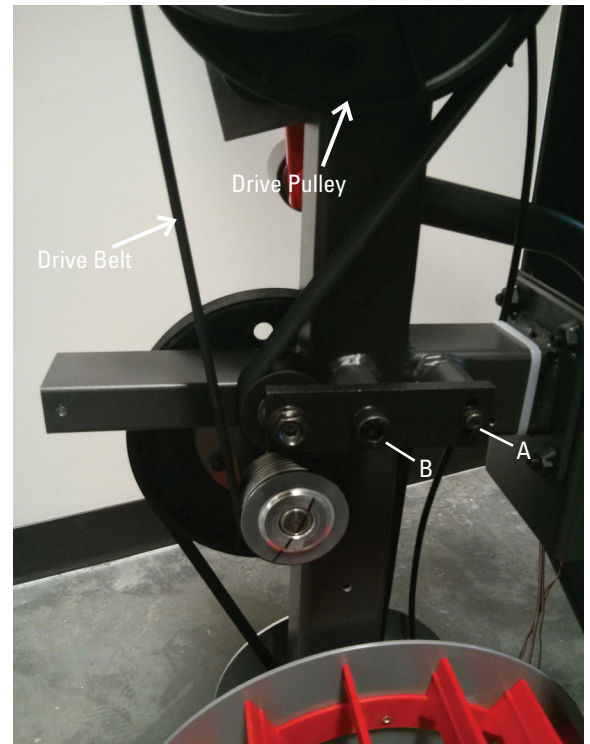

29. Using an appropriately sized hex wrench, remove the four screws that attach the Drive Pulley. Be sure to support the weight of the Drive Pulley when removing hardware because it will fall.

\* If there is a nut securing the screw on the other side of the Drive Pulley, loosen it and then remove the screw.

\* If the head of a screw has broken off, grasp the exposed shaft of the screw with locking pliers and carefully unscrew it.

\* If the locking pliers cannot remove the broken screw, use a drill bit and screw extractor to remove it.

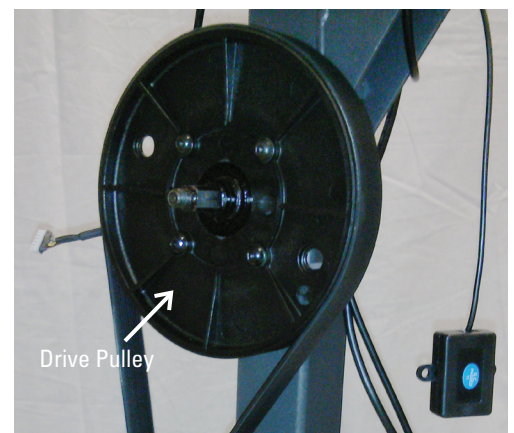



30. Using a 5mm hex wrench, attach the new Drive Pulley to the Frame Assembly with the provided screws and lock washers. Fully install each screw.

31. Using a 10mm wrench, secure each of the screws with a provided securing nut. Be sure all provided hardware is fully tightened.

32. Replace the Drive Belt around the new Drive Pulley. Be sure the Drive Belt is still in place around the lower pulleys.

33. Replace and tighten the "A" screw on the Drive Belt Tensioner Arm, and then tighten the "B" screw.

34. Installation is the reverse procedure excluding steps with the Crank Puller. The Crank Puller is not required for re-assembly.

**Note:** When replacing the Crank Arm be sure the Right and Left Crank Arms are oriented inline and opposite each other.

The Crank Nut should be tightened to a torque value of 29-32.5 ft lbs (or 350-390 in lbs).

#### 35. Final Inspection

Inspect your machine to ensure that all hardware is tight and components are properly assembled.



**Do not use until the machine has been fully assembled and inspected for correct performance in accordance with the Owner's Manual.**

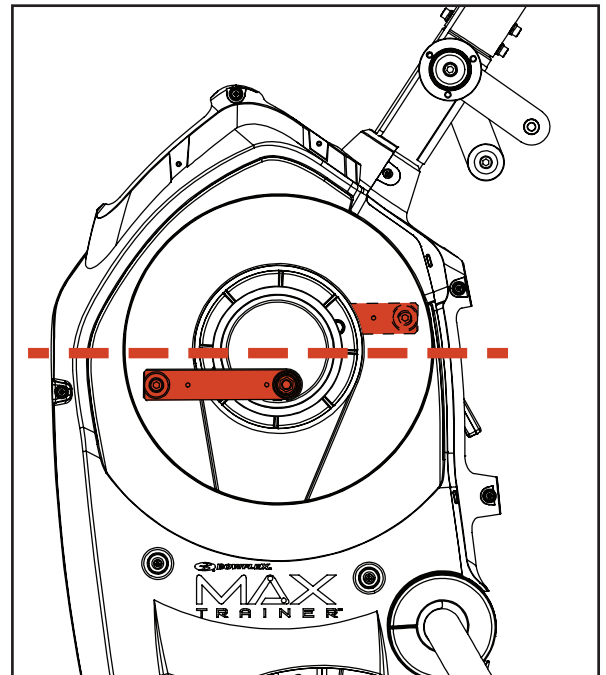

**NOTICE:** This document provides instructions for the replacement of the Hardware that attaches the Drive Pulley on the Bowflex Max Trainer® M3 / M5.

**If you need assistance, please call Bowflex Customer Service at 1-800-605-3369.**

**This icon means a potentially hazardous situation which, if not avoided, could result in death or serious injury. Read and understand all Warnings on this machine.**

Nautilus, Inc., (800) NAUTILUS / (800) 628-8458, www.NautilusInc.com - Customer Service: North America (800) 605-3369, csnl@snautilus.com | outside U.S. www.nautilusinternational.com | Printed in China | © 2014 Nautilus, Inc. | ® indicates trademarks registered in the United States. These marks may be registered in other nations or otherwise protected by common law. Bowflex, the B logo, and Bowflex Max Trainer are trademarks owned by or licensed to Nautilus, Inc.

### Important Safety Instructions - Before servicing or using this equipment, obey the following warnings:

**This icon means a potentially hazardous situation which, if not avoided, could result in death or serious injury. Read and understand all Warnings on this machine.**

- Read and understand the Part Replacement Procedure before working on the machine. Failure to obey the instructions and safety warnings could cause injury to the service technician or bystanders.
- Keep bystanders and children away from the product being serviced at all times.
- Make sure that the repair is done in an appropriate work space away from foot traffic and exposure to bystanders.
- Disconnect all power to the machine before you service it.
- Some components of the equipment can be heavy or awkward. Enlist the service of a second person when you do maintenance steps involving these components. Do not try to do heavy or awkward steps on your own.
- If replacement parts are necessary, use only genuine Nautilus replacement parts and hardware. Failure to use genuine replacement parts can cause a risk to users, keep the machine from operating correctly and will void the warranty.
- Be sure that all warning stickers and instructional placards applied to the product stay present and in good condition when doing maintenance or replacing components. If necessary request replacement warning stickers or placards from Nautilus customer service.
- Do not try to change the design or functionality of the machine being serviced as this can adversely effect user safety and will void the warranty.
- Do not use the machine until all shrouds, instructions, warning labels and correct functionality have been verified and tested for correct performance.

### Tools Required (not included)

#2 Phillips screwdriver

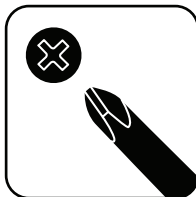

10mm wrench

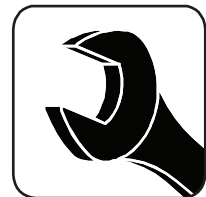

5mm hex wrench  
6mm hex wrench



9/16" or 14mm Socket and Wrench



Crank Puller (non-handled,  
JIS/ISO square taper  
with M22x1.0 threads)

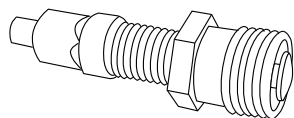

**Note:** The Bowflex Max Trainer® M3 is used in the following images. The procedure is the same for the M5 model.

1. Unplug the AC Adapter from the wall outlet and machine.

2. Using a #2 Phillips screwdriver, remove the 4 screws (2 indicated on one side) from the Console Assembly.



3. Carefully lift the Console Assembly and expose the Cable Connections.



4. Carefully disconnect the Cables noting their locations.

**Note:** do not crimp any of the Console Cables.

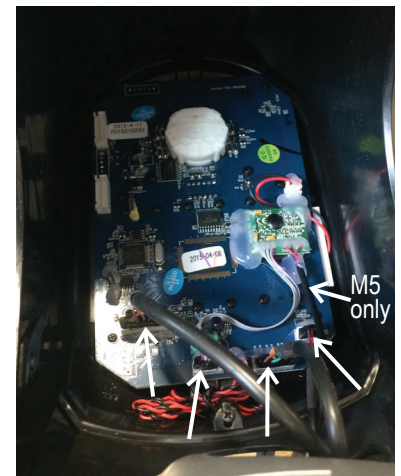

5. Using a 5mm hex wrench, remove the indicated hardware from the Left Upper Handlebar.

**Note:** Be aware that the Upper Handlebar must be supported when removing the hardware.



6. Using a #2 Phillips screwdriver, remove the indicated (by ovals) screws and only loosen the lowest indicated screw (arrow) from the Right Fan Cover.



7. The Right Fan Cover has a tab that needs to be pushed upward to clear the loosened screw. While pushing up on the tab, remove the Right Fan Cover from the assembly.

**Note:** the AC Power Cable is attached to the inside of the Right Fan Cover. Be sure not to crimp the cable by placing the Right Fan Cover close to the front of the machine.

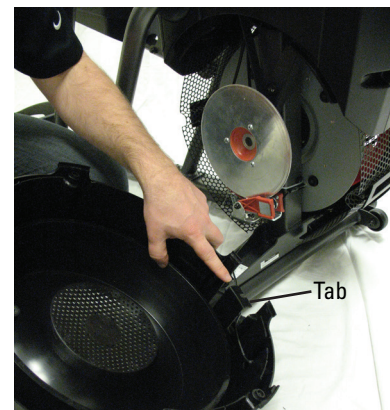
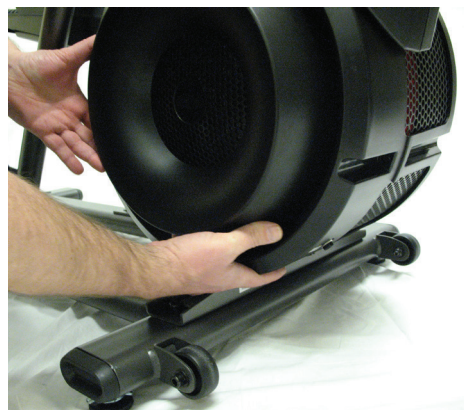

8. Remove the indicated Cap from the machine.

9. Using a 6mm hex wrench, remove the hardware exposed from below the Cap.

10. Slide the Left Leg Assembly off of the machine.



11. Using a #2 Phillips screwdriver, remove the 2 indicated screws from the Left Crank Cover.

**Note:** The image displays the Right Crank Cover being removed.

12. Remove the Left Crank Cover from the machine.



13. Place a rag or protective material below the Left Connector Arm to protect the Shroud from potential scratches from the Connector Arm.

14. Using a 6mm hex wrench, remove the hardware that connects the Left Connector Arm and the Pivot Arm.

**Note:** The Connector Arm will pivot downward if not lowered slowly onto the rag protecting the Shroud.

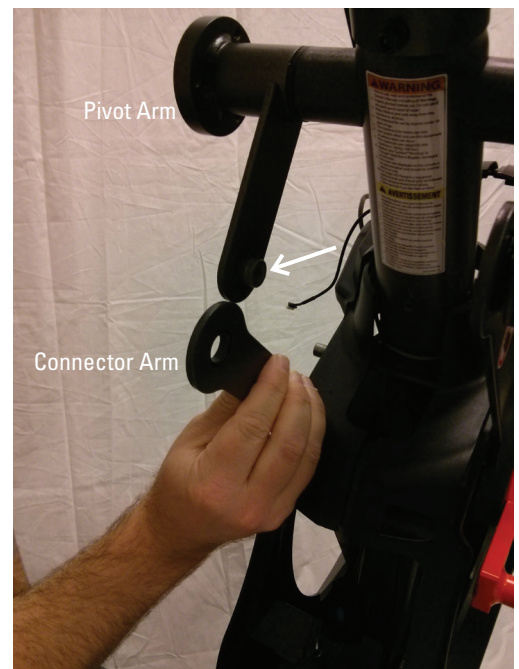

15. Using a 9/16" or 14mm socket and wrench, remove the nut from the Left Crank Assembly.



16. Adjust the Crank Puller until the end of the Bolt is flush with the Nut (as shown).

17. Carefully thread the Crank Puller into the Left Crank Arm. Be sure the Crank Puller has at least three rounds of threads inserted.



18. Using a 16mm wrench, turn the inner portion (the Bolt) of the Crank Puller clockwise. The Left Crank Arm will slide off as it is tightened.

**Note:** Be aware that the Left Crank Arm will be loose and will need to be supported.

19. Remove the Crank Puller from the Left Crank Arm.

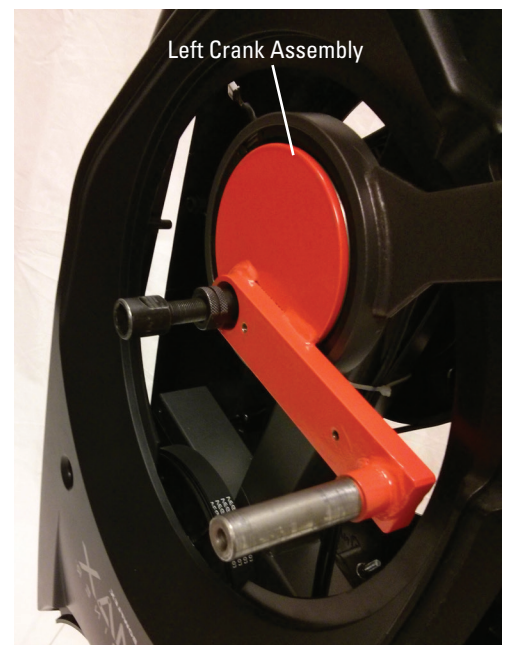

**Note:** Shrouds are removed for clarity.

20. Inspect the Drive Pulley and the screws that secure it.

\* If the Drive Pulley is worn or damaged OR any of the screws have been sheared off, use the “Replace the Drive Pulley” Procedure for replacement instructions.

\* If one or more screws are currently missing, skip to Step 21.

\* If all four screws are present, use an appropriately sized hex wrench to remove one of the four screws that attach the Drive Pulley.

21. Using a 5mm hex wrench, attach one of the replacement screws and lock washers provided in the kit. Fully tighten the screw. Once fully tightened, secure the screw with one of the provided securing nuts using a 10mm wrench.

22. Rotate the Drive Pulley to replace each screw with the provided hardware (screw and securing nut) one at a time.

**Note:** The kit contains a replacement Drive Pulley. This part will not be used if this procedure is performed correctly.

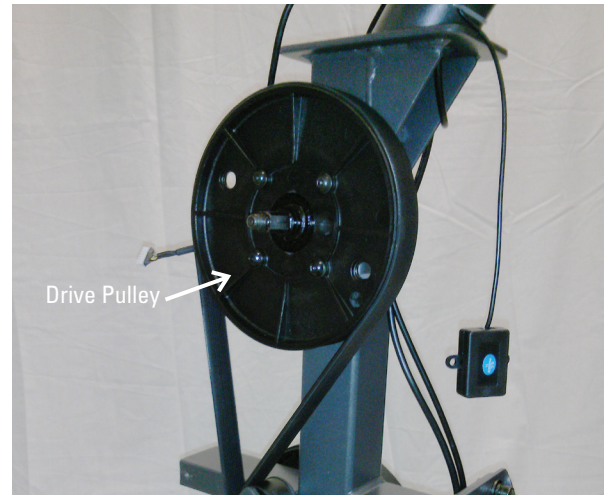

23. Installation is the reverse procedure excluding steps with the Crank Puller. The Crank Puller is not required for re-assembly.

**Note:** When replacing the Crank Arm be sure the Right and Left Crank Arms are oriented inline and opposite each other.

The Crank Nut should be tightened to a torque value of 29-32.5 ft lbs (or 350-390 in lbs).

24. Final Inspection

Inspect your machine to ensure that all hardware is tight and components are properly assembled.



**Do not use until the machine has been fully assembled and inspected for correct performance in accordance with the Owner's Manual.**

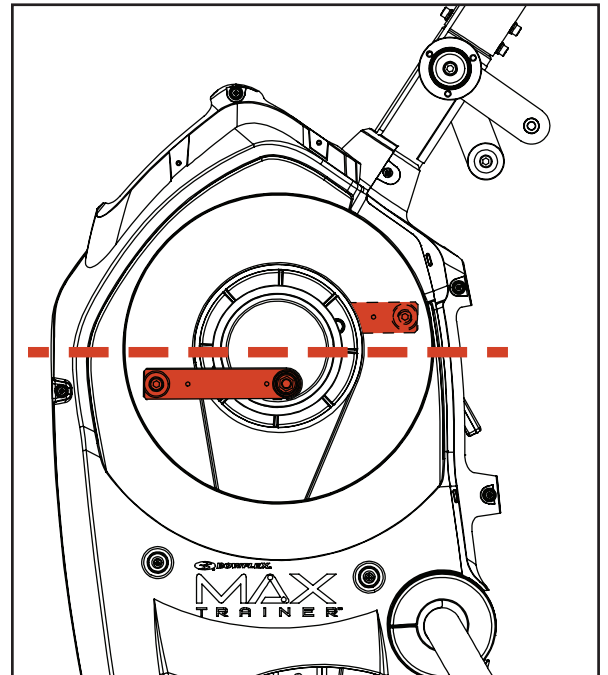

**NOTICE:** This document provides instructions for the replacement of the Fan Assembly on the Bowflex Max Trainer® M3 / M5.

**If you need assistance, please call Bowflex Customer Service at 1-800-605-3369.**

 **This icon means a potentially hazardous situation which, if not avoided, could result in death or serious injury. Read and understand all Warnings on this machine.**

Nautilus, Inc., (800) NAUTILUS / (800) 628-8458, www.NautilusInc.com - Customer Service: North America (800) 605-3369, csnls@nautilus.com | outside U.S. www.nautilusinternational.com | Printed in China | © 2014 Nautilus, Inc. | ® indicates trademarks registered in the United States. These marks may be registered in other nations or otherwise protected by common law. Bowflex, the B logo, and Bowflex Max Trainer are trademarks owned by or licensed to Nautilus, Inc.

### Important Safety Instructions - Before servicing or using this equipment, obey the following warnings:

 **This icon means a potentially hazardous situation which, if not avoided, could result in death or serious injury. Read and understand all Warnings on this machine.**

- Read and understand the Part Replacement Procedure before working on the machine. Failure to obey the instructions and safety warnings could cause injury to the service technician or bystanders.
- Keep bystanders and children away from the product being serviced at all times.
- Make sure that the repair is done in an appropriate work space away from foot traffic and exposure to bystanders.
- Disconnect all power and allow to sit for 5 minutes before you service this machine.
- Some components of the equipment can be heavy or awkward. Enlist the service of a second person when you do maintenance steps involving these components. Do not try to do heavy or awkward steps on your own.
- If replacement parts are necessary, use only genuine Nautilus replacement parts and hardware. Failure to use genuine replacement parts can cause a risk to users, keep the machine from operating correctly and will void the warranty.
- Be sure that all warning stickers and instructional placards applied to the product stay present and in good condition when doing maintenance or replacing components. If necessary request replacement warning stickers or placards from Nautilus customer service.
- Do not try to change the design or functionality of the machine being serviced as this can adversely effect user safety and will void the warranty.
- Do not use the machine until all shrouds, instructions, warning labels and correct functionality have been verified and tested for correct performance.

### Tools Required (not included)

#2 Phillips screwdriver

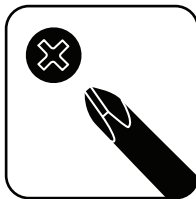

5mm hex wrench



Standard Screwdriver





**Note:** The Bowflex Max Trainer® M3 is used in the following images. The procedure is the same for the M5 model.

1. Unplug the AC Adapter from the machine and wait 5 minutes.

2. Using a #2 Phillips screwdriver, remove the indicated (by ovals) screws and only loosen the lowest indicated screw (arrow) from the Right Fan Cover.

3. The Right Fan Cover has a tab that needs to be pushed upward to clear the loosened screw. While pushing up on the tab, remove the Right Fan Cover from the assembly.

**Note:** the AC Power Cable is attached to the inside of the Right Fan Cover. Be sure not to crimp the cable by placing the Right Fan Cover close to the front of the machine.

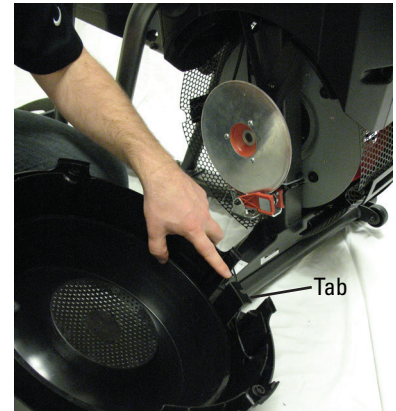

4. Using a #2 Phillips screwdriver, remove the indicated (by ovals) screws and only loosen the lowest indicated screw (arrow) from the Left Fan Cover.

5. The Left Fan Cover Assembly has a tab that needs to be pushed upward to clear the loosened screw. While pushing up on the tab, remove the Left Fan Cover Assembly.

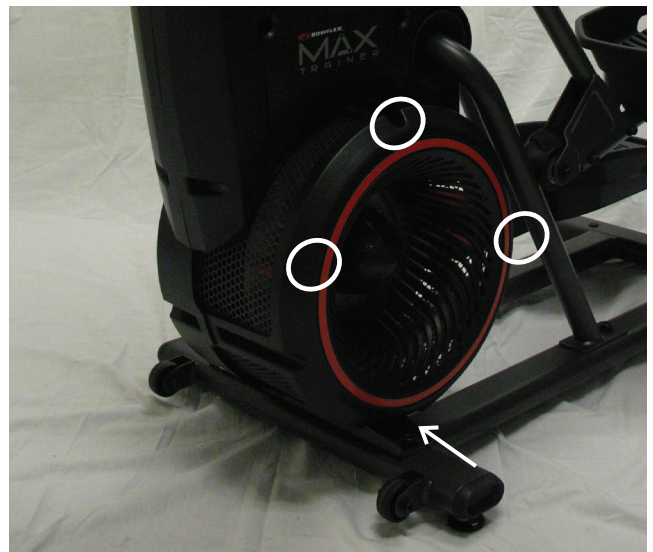

6. Remove the Left Fan Cover Assembly from the machine. Be sure to note how the fan screens are set into the Left Fan Cover to assist with the replacement procedure.

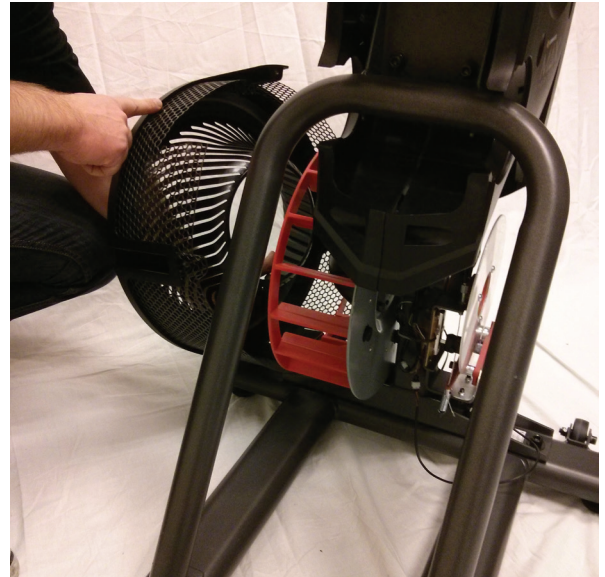

7. Remove the Cone from the Fan Assembly. There are 4 clips that attach the Cone that can be accessed behind the Fan Assembly. Using a small standard screwdriver, gently release the clips.

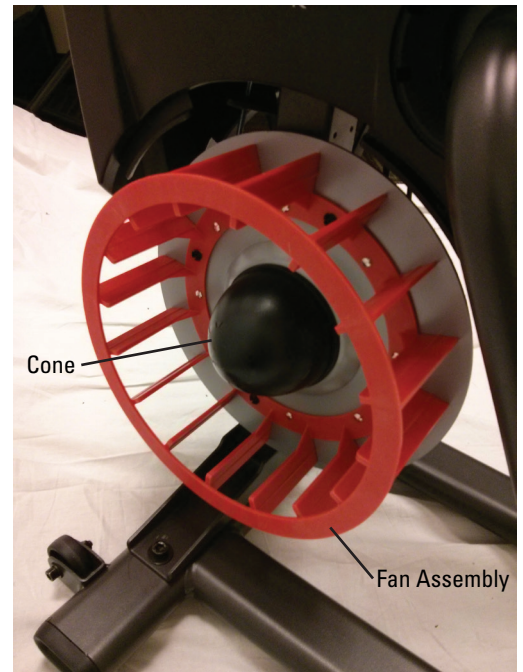

8. Using a 5mm hex wrench, remove the 4 screws from the Fan Assembly. Be sure to support the Fan Assembly when removing hardware.

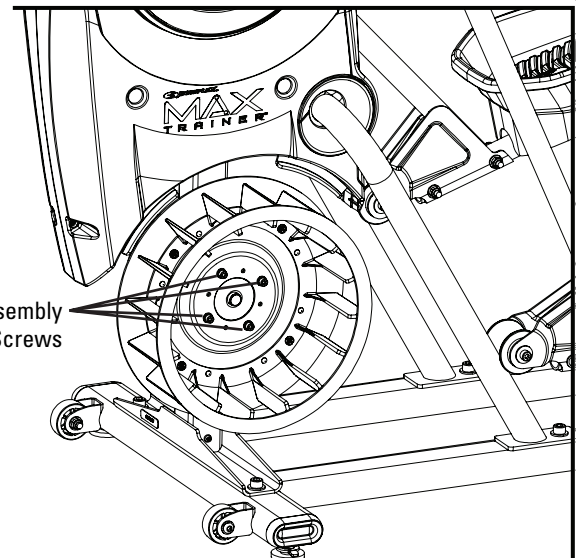

9. Installation is the reverse procedure.

10. Final Inspection  
Inspect your machine to ensure that all hardware is tight and components are properly assembled.

 **Do not use until the machine has been fully assembled and inspected for correct performance in accordance with the Owner's Manual.**

**NOTICE:** This document provides instructions for the replacement of the Fan Belt on the Bowflex Max Trainer® M3 / M5.

**If you need assistance, please call Bowflex Customer Service at 1-800-605-3369.**

 **This icon means a potentially hazardous situation which, if not avoided, could result in death or serious injury. Read and understand all Warnings on this machine.**

Nautilus, Inc., (800) NAUTILUS / (800) 628-8458, www.NautilusInc.com - Customer Service: North America (800) 605-3369, csnls@nautilus.com | outside U.S. www.nautilusinternational.com | Printed in China | © 2014 Nautilus, Inc. | ® indicates trademarks registered in the United States. These marks may be registered in other nations or otherwise protected by common law. Bowflex, the B logo, and Bowflex Max Trainer are trademarks owned by or licensed to Nautilus, Inc.

### Important Safety Instructions - Before servicing or using this equipment, obey the following warnings:

 **This icon means a potentially hazardous situation which, if not avoided, could result in death or serious injury. Read and understand all Warnings on this machine.**

- Read and understand the Part Replacement Procedure before working on the machine. Failure to obey the instructions and safety warnings could cause injury to the service technician or bystanders.
- Keep bystanders and children away from the product being serviced at all times.
- Make sure that the repair is done in an appropriate work space away from foot traffic and exposure to bystanders.
- Disconnect all power and allow to sit for 5 minutes before you service this machine.
- Some components of the equipment can be heavy or awkward. Enlist the service of a second person when you do maintenance steps involving these components. Do not try to do heavy or awkward steps on your own.
- If replacement parts are necessary, use only genuine Nautilus replacement parts and hardware. Failure to use genuine replacement parts can cause a risk to users, keep the machine from operating correctly and will void the warranty.
- Be sure that all warning stickers and instructional placards applied to the product stay present and in good condition when doing maintenance or replacing components. If necessary request replacement warning stickers or placards from Nautilus customer service.
- Do not try to change the design or functionality of the machine being serviced as this can adversely effect user safety and will void the warranty.
- Do not use the machine until all shrouds, instructions, warning labels and correct functionality have been verified and tested for correct performance.

### Tools Required (not included)

#2 Phillips screwdriver

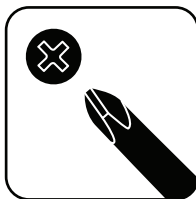

#2 Standard screwdriver



6mm hex wrench



10mm wrench

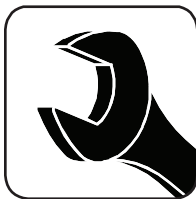

**Note:** The Bowflex Max Trainer® M3 is used in the following images. The procedure is the same for the M5 model.

1. Unplug the AC Adapter from the machine and wait 5 minutes.
2. Using a #2 Phillips screwdriver, remove the 4 screws (2 indicated on one side) from the Console Assembly.



3. Carefully lift the Console Assembly and expose the Cable Connections.



4. Carefully disconnect the Cables noting their locations.

**Note:** do not crimp any of the Console Cables.

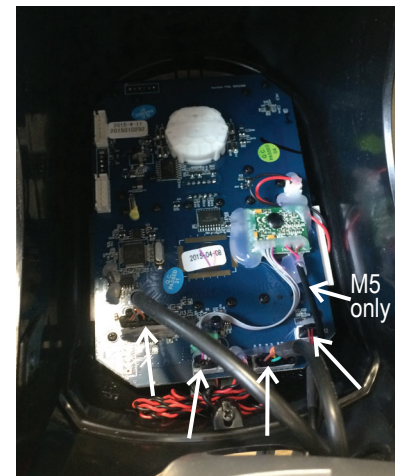

5. Using a 5mm hex wrench, remove the indicated hardware from the Upper Handlebars.

**Note:** Be aware that the Upper Handlebars must be supported when removing the hardware.



6. Using a #2 Phillips screwdriver, remove the indicated (by ovals) screws and only loosen the lowest indicated screw (arrow) from the Right Fan Cover.



7. The Right Fan Cover has a tab that needs to be pushed upward to clear the loosened screw. While pushing up on the tab, remove the Right Fan Cover from the assembly.

**Note:** the AC Power Cable is attached to the inside of the Right Fan Cover. Be sure not to crimp the cable by placing the Right Fan Cover close to the front of the machine.

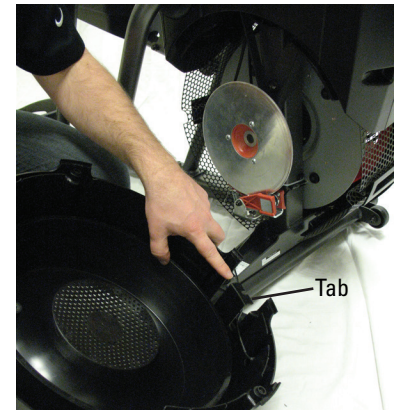
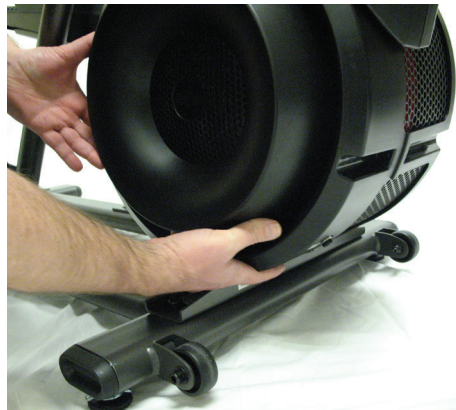

8. Remove the indicated Cap from both sides of the machine.

9. Using a 6mm hex wrench, remove the hardware exposed from below the Cap from both sides of the machine.

10. Slide the Leg Assemblies off of the machine.



11. Using a #2 Phillips screwdriver, remove the indicated screw from the Rear Shroud.

12. Carefully remove the Rear Shroud from the machine. Place a standard screwdriver behind and near the middle of the Rear Shroud and gently pry until it releases. Then move the screwdriver to the bottom and gently pry until the Rear Shroud comes off.

13. Remove the indicated Caps from the machine.

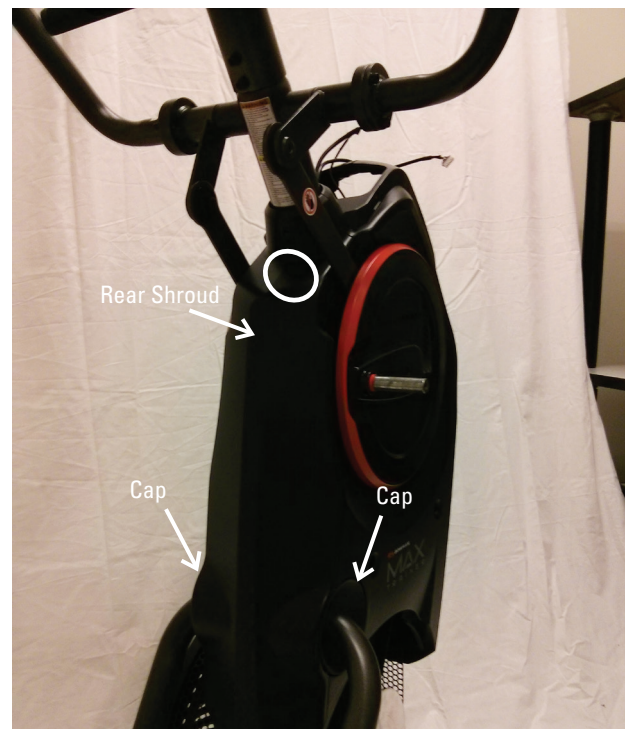

14. Using a #2 Phillips screwdriver, remove the indicated (by ovals) screws and only loosen the lowest indicated screw (arrow) from the Left Fan Cover.

15. The Left Fan Cover Assembly has a tab that needs to be pushed upward to clear the loosened screw. While pushing up on the tab, remove the Left Fan Cover Assembly.

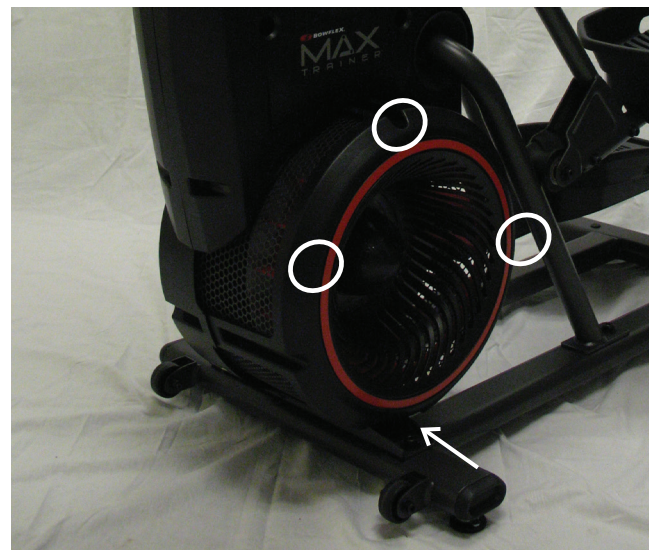

16. Remove the Left Fan Cover Assembly from the machine. Be sure to note how the fan screens are set into the Left Fan Cover to assist with the replacement procedure.

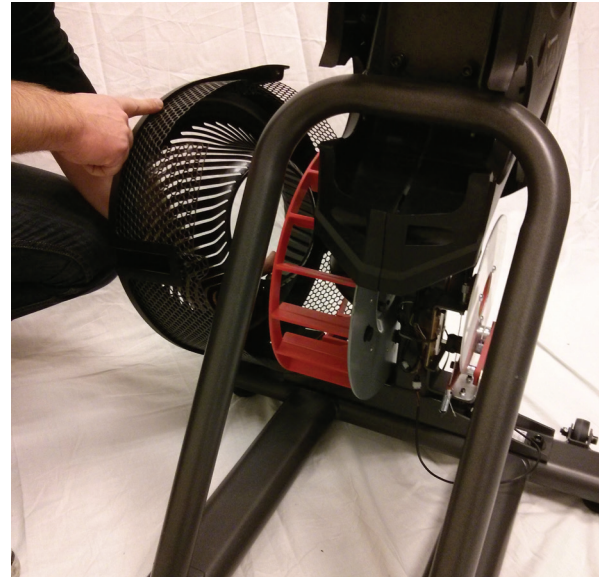

17. Using a #2 Phillips screwdriver, remove the 2 indicated screws from the Crank Cover. Repeat on the other side of the machine.

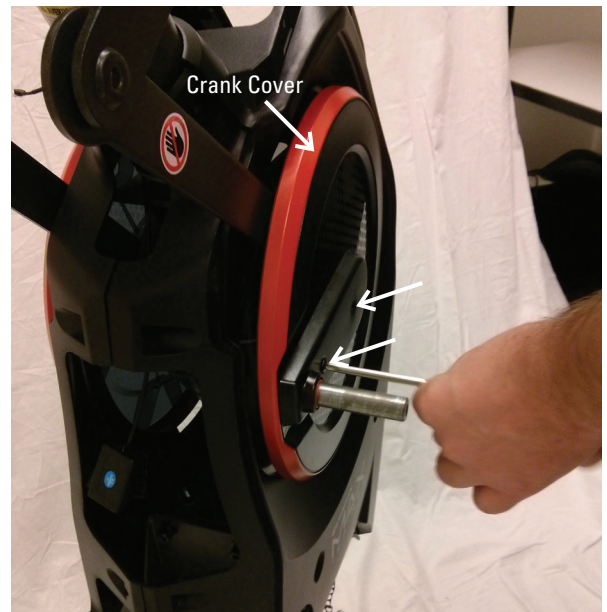

18. Remove the Crank Covers from the machine.

19. Place a rag or protective material below the Connector Arm to protect the Shrouds from potential scratches from the Connector Arms.

20. Using a 6mm hex wrench, remove the hardware that connects the Connector Arms and the Pivot Arms.

**Note:** The Connector Arm will pivot downward if not lowered slowly onto the rag protecting the Shrouds.

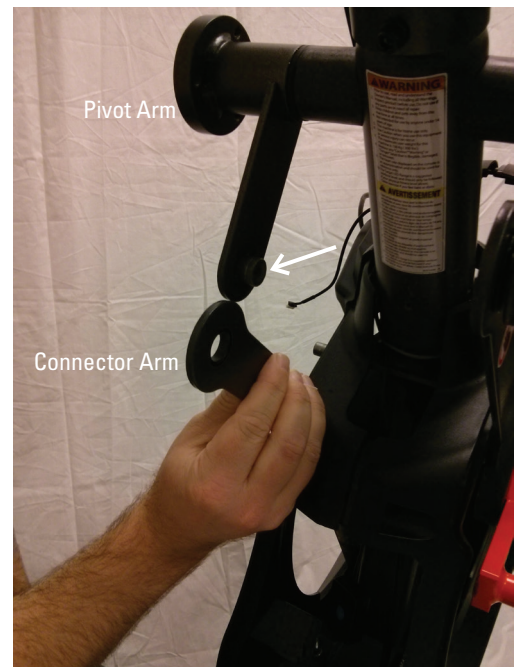

21. Using a #2 Phillips screwdriver, remove the screws from the Right and Left Shrouds. ( 3 screws on the Right Shroud, 9 on the Left Shroud)  
Remove the upper screws labeled ' \* ' last.

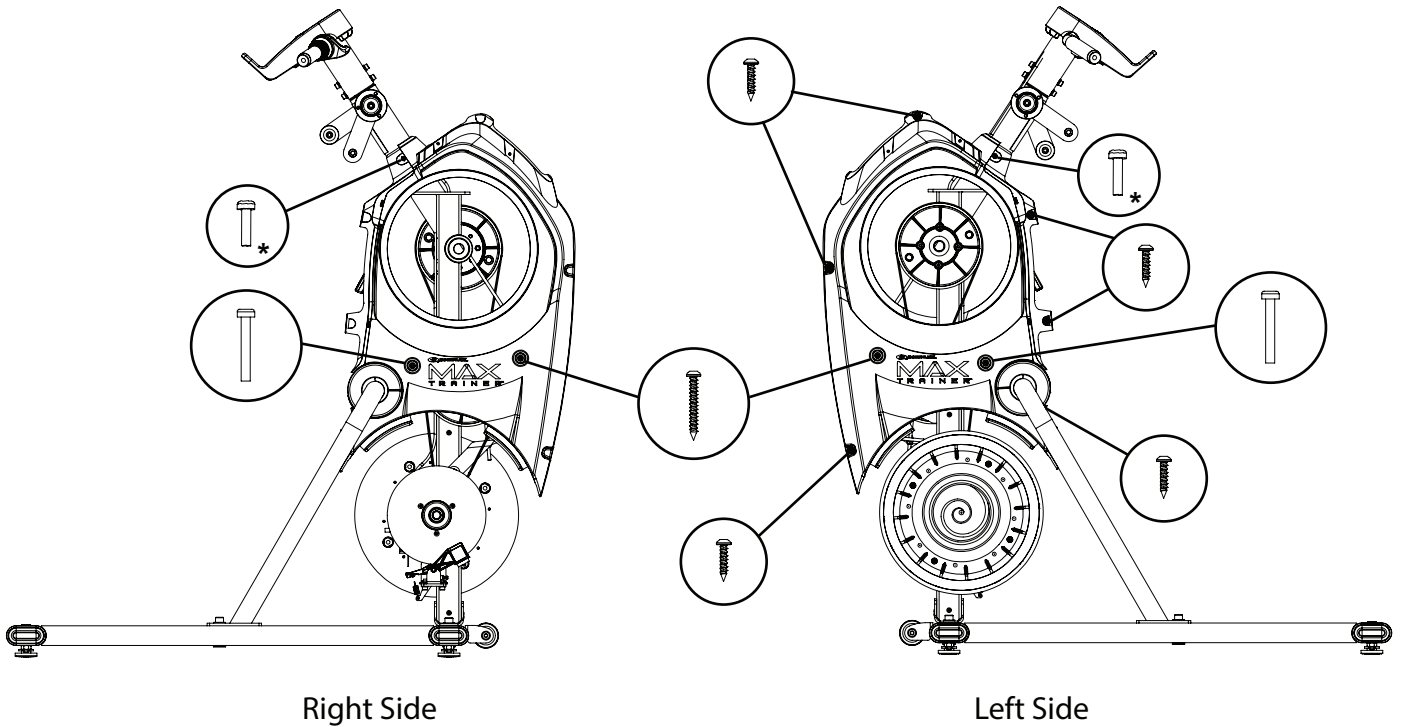

22. Place pieces of cardboard between the Brake Magnets and the Disc Brake.

23. Using a #2 Phillips screwdriver, remove the 3 indicated screws from the Disc Brake.

24. Carefully remove the Disc Brake from the machine exposing the lower Fan Belt.

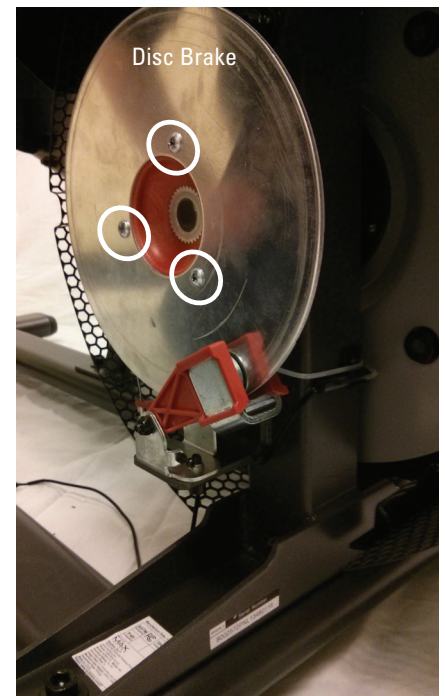
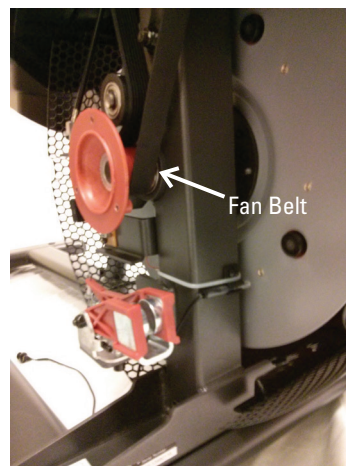



25. Note the number of exposed threads below the Tensioner Adjustment Nut. This will assist with re-assembly.

26. Using a 10mm open face wrench, loosen the Tensioner Adjustment Nut on the Tensioner Bolt until the old Fan Belt can be removed. Remove the old Fan Belt and replace with the new Fan Belt.

 **Keep fingers out of any pinch opportunities when removing the Fan Belt.**

**Note:** If the Fan Belt Tensioner does not adjust as the Tensioning Bolt is loosened, it may have been assembled too tightly. Slightly loosen the securing screw to allow it to adjust.

27. Replace and tighten the Tension Adjustment Nut to the same location on the Tensioner Bolt.

28. Installation is the reverse procedure excluding steps with the Crank Puller.

29. Final Inspection

Inspect your machine to ensure that all hardware is tight and components are properly assembled.

 **Do not use until the machine has been fully assembled and inspected for correct performance in accordance with the Owner's Manual.**

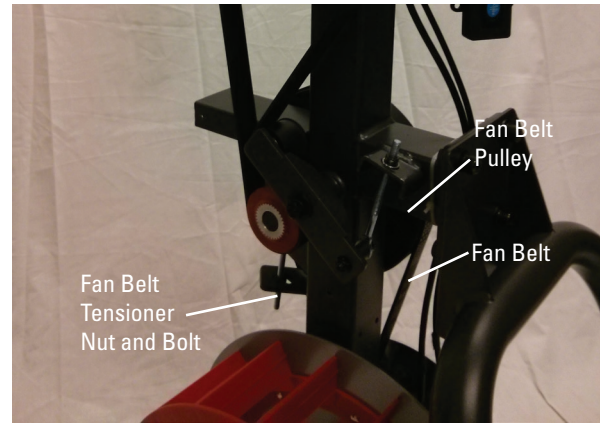

**NOTICE:** This document provides instructions for the replacement of the Fan Pulley on the Bowflex Max Trainer® M3 / M5.

If you need assistance, please call **Bowflex Customer Service at 1-800-605-3369.**

This icon means a potentially hazardous situation which, if not avoided, could result in death or serious injury. Read and understand all Warnings on this machine.

Nautilus, Inc., (800) NAUTILUS / (800) 628-8458, www.NautilusInc.com - Customer Service: North America (800) 605-3369, csnls@nautilus.com | outside U.S. www.nautilusinternational.com | Printed in China | © 2014 Nautilus, Inc. | ® indicates trademarks registered in the United States. These marks may be registered in other nations or otherwise protected by common law. Bowflex, the B logo, and Bowflex Max Trainer are trademarks owned by or licensed to Nautilus, Inc.

### Important Safety Instructions - Before servicing or using this equipment, obey the following warnings:

This icon means a potentially hazardous situation which, if not avoided, could result in death or serious injury. Read and understand all Warnings on this machine.

- Read and understand the Part Replacement Procedure before working on the machine. Failure to obey the instructions and safety warnings could cause injury to the service technician or bystanders.
- Keep bystanders and children away from the product being serviced at all times.
- Make sure that the repair is done in an appropriate work space away from foot traffic and exposure to bystanders.
- Disconnect all power and allow to sit for 5 minutes before you service this machine.
- Some components of the equipment can be heavy or awkward. Enlist the service of a second person when you do maintenance steps involving these components. Do not try to do heavy or awkward steps on your own.
- If replacement parts are necessary, use only genuine Nautilus replacement parts and hardware. Failure to use genuine replacement parts can cause a risk to users, keep the machine from operating correctly and will void the warranty.
- Be sure that all warning stickers and instructional placards applied to the product stay present and in good condition when doing maintenance or replacing components. If necessary request replacement warning stickers or placards from Nautilus customer service.
- Do not try to change the design or functionality of the machine being serviced as this can adversely effect user safety and will void the warranty.
- Do not use the machine until all shrouds, instructions, warning labels and correct functionality have been verified and tested for correct performance.

### Tools Required (not included)

#2 Phillips screwdriver



10mm wrench  
16mm wrench



9/16" or 14mm Socket and Wrench



6 mm hex wrench



Crank Puller (non-handled,  
JIS/ISO square taper  
with M22x1.0 threads)

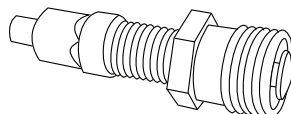

**Note:** The Bowflex Max Trainer® M3 is used in the following images. The procedure is the same for the M5 model.

1. Unplug the AC Adapter from the machine and wait 5 minutes.
2. Using a #2 Phillips screwdriver, remove the 4 screws (2 indicated on one side) from the Console Assembly.



3. Carefully lift the Console Assembly and expose the Cable Connections.



4. Carefully disconnect the Cables noting their locations.

**Note:** do not crimp any of the Console Cables.

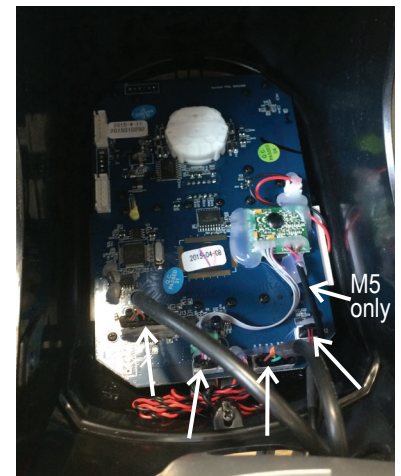

5. Using a 5mm hex wrench, remove the indicated hardware from the Right Upper Handlebar.

**Note:** Be aware that the Right Upper Handlebar must be supported when removing the hardware.



6. Using a #2 Phillips screwdriver, remove the indicated (by ovals) screws and only loosen the lowest indicated screw (arrow) from the Right Fan Cover.



7. The Right Fan Cover has a tab that needs to be pushed upward to clear the loosened screw. While pushing up on the tab, remove the Right Fan Cover from the assembly.

**Note:** the AC Power Cable is attached to the inside of the Right Fan Cover. Be sure not to crimp the cable by placing the Right Fan Cover close to the front of the machine.

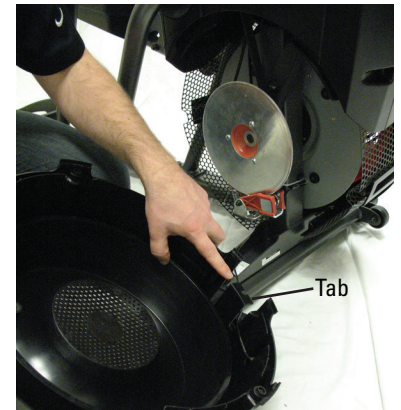
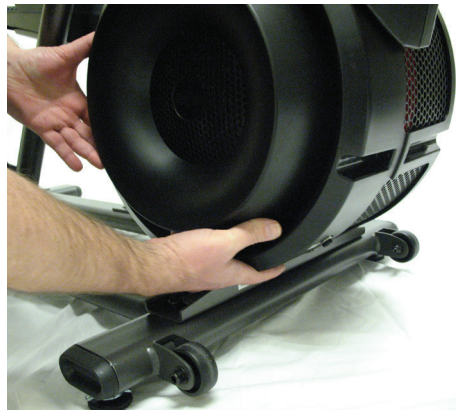

8. Remove the indicated Cap from the machine.

9. Using a 6mm hex wrench, remove the hardware exposed from below the Cap.

10. Slide the Leg Assembly off of the machine.



11. Using a #2 Phillips screwdriver, remove the indicated screw from the Rear Shroud.

12. Carefully remove the Rear Shroud from the machine. Place a standard screwdriver behind and near the middle of the Rear Shroud and gently pry until it releases. Then move the screwdriver to the bottom and gently pry until the Rear Shroud comes off.

13. Remove the indicated Caps from the machine.

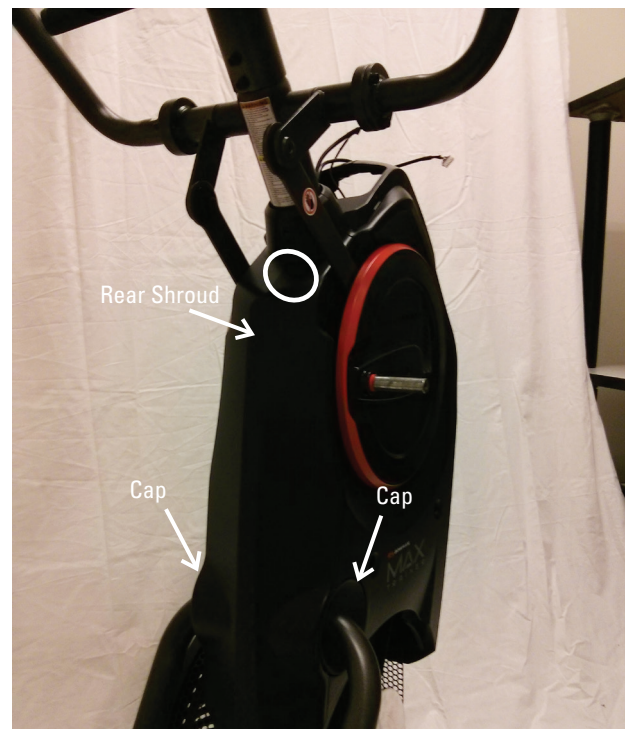

14. Using a #2 Phillips screwdriver, remove the indicated (by ovals) screws and only loosen the lowest indicated screw (arrow) from the Left Fan Cover.

15. The Left Fan Cover Assembly has a tab that needs to be pushed upward to clear the loosened screw. While pushing up on the tab, remove the Left Fan Cover Assembly.

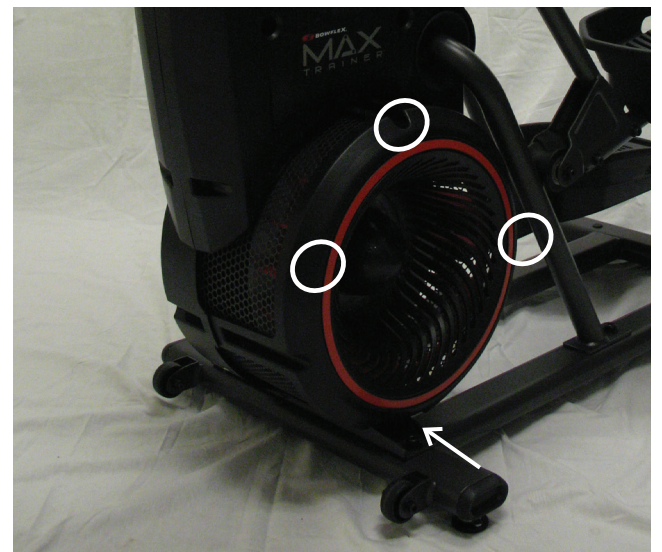

16. Remove the Left Fan Cover Assembly from the machine. Be sure to note how the fan screens are set into the Left Fan Cover to assist with the replacement procedure.

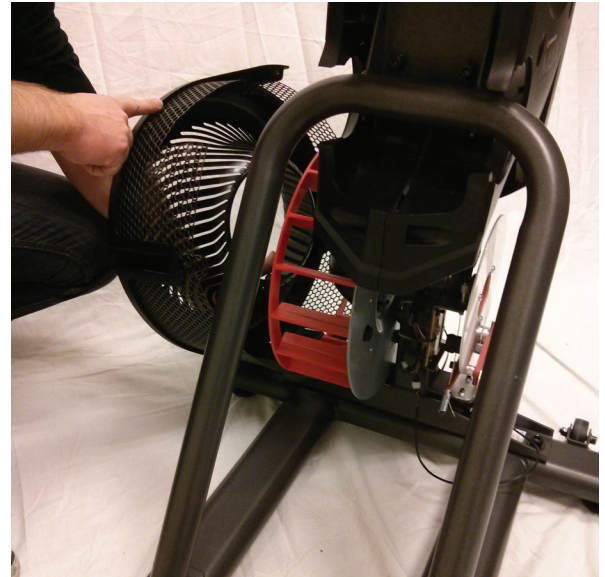

17. Using a #2 Phillips screwdriver, remove the 2 indicated screws from the Right Crank Cover.

18. Remove the Right Crank Cover from the machine.

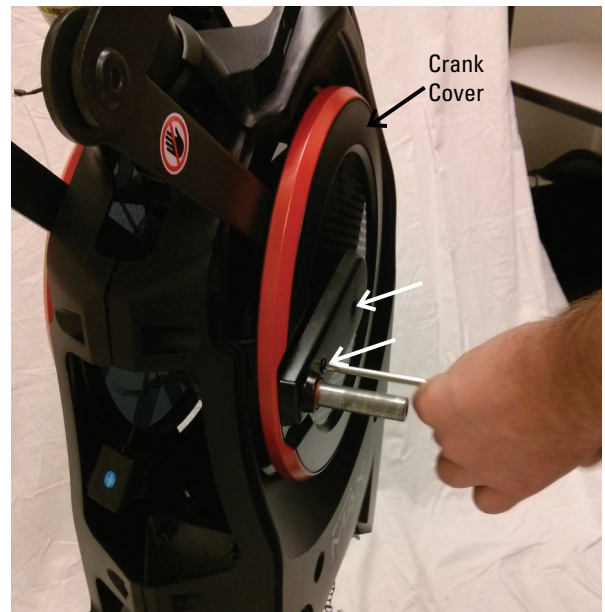

19. Place a rag or protective material below the Right Connector Arm to protect the Shrouds from potential scratches from the Connector Arms.

20. Using a 6mm hex wrench, remove the hardware that connects the Right Connector Arm and the Pivot Arm.

**Note:** The Connector Arm will pivot downward if not lowered slowly onto the rag protecting the Shroud.

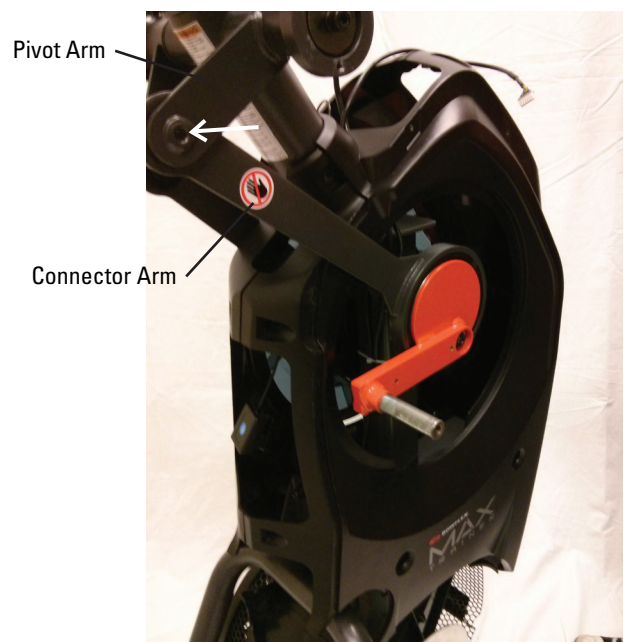

21. Using a 9/16" or 14mm socket and wrench, remove the nut from the Right Crank Assembly.

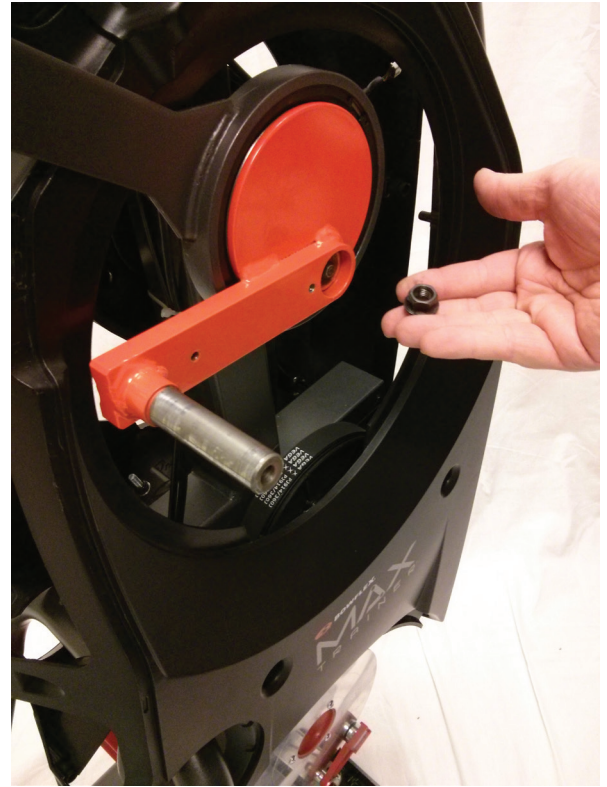

22. Adjust the Crank Puller until the end of the Bolt is flush with the Nut (as shown).



23. Carefully thread the Crank Puller into the Right Crank Arm. Be sure the Crank Puller has at least three rounds of threads inserted.

24. Using a 16mm wrench, turn the inner portion (the Bolt) of the Crank Puller clockwise. The Right Crank Arm will slide off as it is tightened.

**Note:** Be aware that the Right Crank Arm will be loose and will need to be supported.

25. Remove the Crank Puller from the Right Crank Arm.

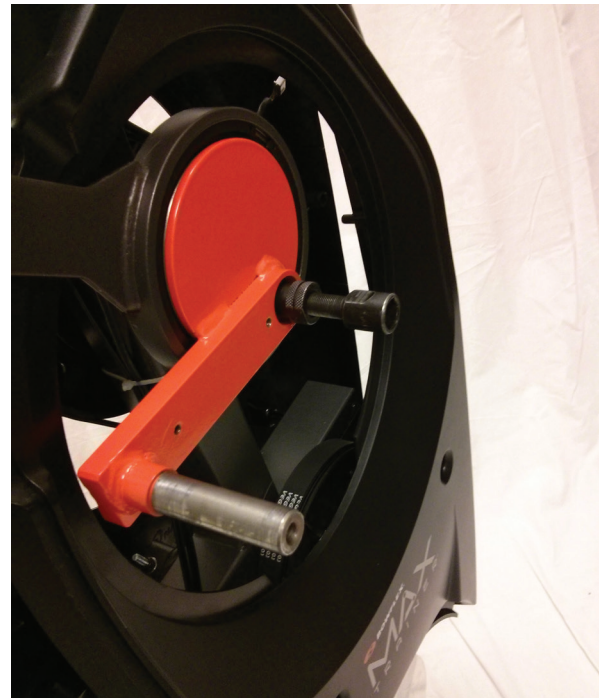

26. Using a #2 Phillips screwdriver, remove the screws from the Right Shroud ( 3 screws on the Right Shroud). Remove the upper screws labeled ' \* ' last.

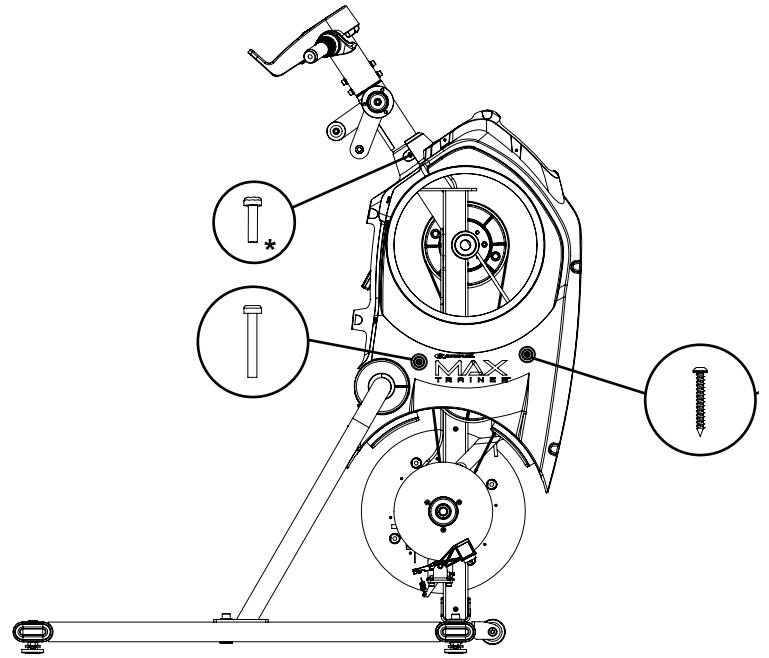

Right Side

27. Place pieces of cardboard between the Brake Magnets and the Disc Brake.

28. Using a #2 Phillips screwdriver, remove the 3 indicated screws from the Disc Brake.

29. Carefully remove the Disc Brake from the machine exposing the lower Fan Belt.

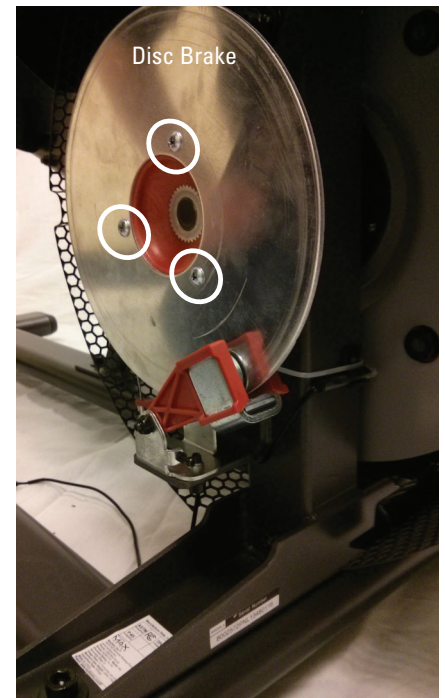
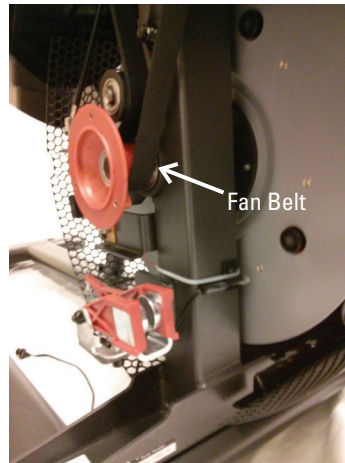



**Note:** Left Shroud is removed for clarity.

30. Note the number of exposed threads below the Tensioner Adjustment Nut. This will assist with re-assembly.

31. Using a 10mm open face wrench, loosen the Tensioner Adjustment Nut on the Tensioner Bolt until the Fan Belt can be removed. Remove the Fan Belt from the Fan Pulley.



**Keep fingers out of any pinch opportunities when removing the Fan Belt.**

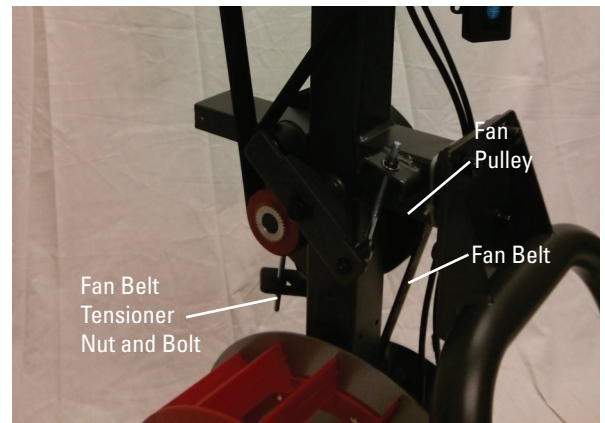

32. Using a 5mm hex wrench, remove the four screws that attach the Fan Pulley. Be sure to support the weight of the Fan Pulley when removing hardware because it will fall.

33. Using a 5mm hex wrench, attach the new Fan Pulley to the Frame Assembly.

34. Replace the Fan Belt around the new Fan Pulley.

35. Replace and tighten the Tension Adjustment Nut to the same location on the Tensioner Bolt.

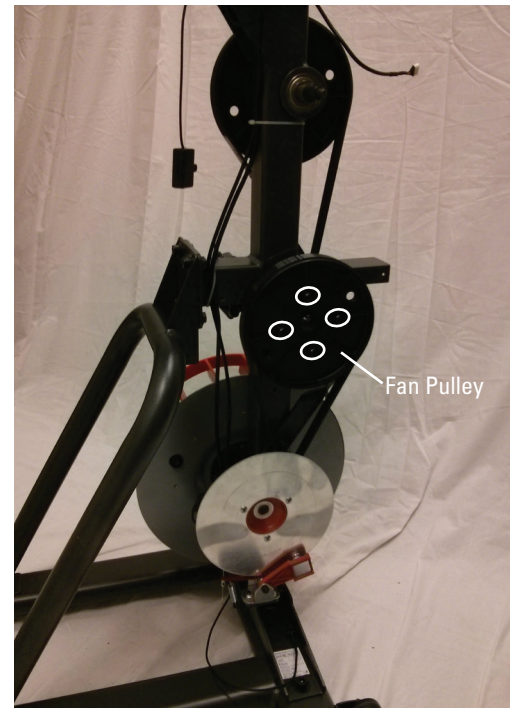

36. Installation is the reverse procedure excluding steps with the Crank Puller. The Crank Puller is not required for re-assembly.

**Note:** When replacing the Crank Arms, be sure the Right and Left Crank Arms are oriented inline and opposite each other.

The Crank Nuts should be tightened to a torque value of 29-32.5 ft lbs (or 350-390 in lbs).

37. Final Inspection

Inspect your machine to ensure that all hardware is tight and components are properly assembled.



**Do not use until the machine has been fully assembled and inspected for correct performance in accordance with the Owner's Manual.**

**NOTICE:** This document provides instructions for the replacement of the Frame Assembly on the Bowflex Max Trainer® M3 / M5.

If you need assistance, please call **Bowflex Customer Service at 1-800-605-3369.**

**!** This icon means a potentially hazardous situation which, if not avoided, could result in death or serious injury. Read and understand all Warnings on this machine.

Nautilus, Inc., (800) NAUTILUS / (800) 628-8458, www.NautilusInc.com - Customer Service: North America (800) 605-3369, csnls@nautilus.com | outside U.S. www.nautilusinternational.com | Printed in China | © 2017 Nautilus, Inc. | ® indicates trademarks registered in the United States. These marks may be registered in other nations or otherwise protected by common law. Bowflex, the B logo, and Bowflex Max Trainer are trademarks owned by or licensed to Nautilus, Inc.

### Important Safety Instructions - Before servicing or using this equipment, obey the following warnings:

**!** This icon means a potentially hazardous situation which, if not avoided, could result in death or serious injury. Read and understand all Warnings on this machine.

- Read and understand the Part Replacement Procedure before working on the machine. Failure to obey the instructions and safety warnings could cause injury to the service technician or bystanders.
- Keep bystanders and children away from the product being serviced at all times.
- Make sure that the repair is done in an appropriate work space away from foot traffic and exposure to bystanders.
- Disconnect all power and allow to sit for 5 minutes before you service this machine.
- Some components of the equipment can be heavy or awkward. Enlist the service of a second person when you do maintenance steps involving these components. Do not try to do heavy or awkward steps on your own.
- If replacement parts are necessary, use only genuine Nautilus replacement parts and hardware. Failure to use genuine replacement parts can cause a risk to users, keep the machine from operating correctly and will void the warranty.
- Be sure that all warning stickers and instructional placards applied to the product stay present and in good condition when doing maintenance or replacing components. If necessary request replacement warning stickers or placards from Nautilus customer service.
- Do not try to change the design or functionality of the machine being serviced as this can adversely effect user safety and will void the warranty.
- Do not use the machine until all shrouds, instructions, warning labels and correct functionality have been verified and tested for correct performance.

### Tools Required (included)



#2 Phillips screwdriver

5mm hex wrench  
6mm hex wrench  
8mm hex wrench



13mm wrench



### Hardware

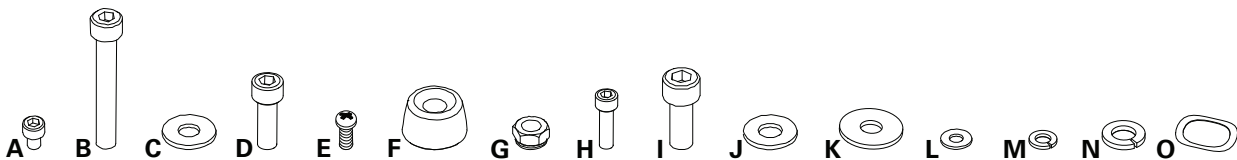

Item	Qty	Description	Item	Qty	Description
A	8	Socket Head Hex Screw, M6x1.0x8	H	10	Socket Head Hex Screw, M6x1.0x20
B	4	Socket Head Hex Screw, M8x1.25x55	I	4	Socket Head Hex Screw, M10x1.5x25
C	12	Washer, Flat M8x18	J	4	Washer, Flat M10x23
D	6	Socket Head Hex Screw, M8x1.25x20	K	2	Washer, Flat M8x24
E	1	Pan Phillips Screw, M5x0.8x20	L	4	Washer, Flat M6x13
F	2	Cap	M	10	Lock Washer, M6
G	4	Lock Nut, M8	N	6	Lock Washer, M8

**Note:** Replace any damaged hardware with the new hardware provided with this kit for re-assembly.

The Bowflex Max Trainer® M3 is used in the following images.

1. Unplug the AC Adapter from the wall outlet and machine.

2. Using a 5mm hex wrench, remove the indicated hardware from the Upper Handlebars.

**Note:** Be aware that the Upper Handlebars must be supported when removing the hardware.



3. Remove the indicated Cap from both sides of the machine.

4. Using a 6mm hex wrench, remove the hardware exposed from below the Cap from both sides of the machine.

5. Slide the Leg Assemblies off of the machine.



6. Using a #2 Phillips screwdriver, remove the indicated screw from the Rear Shroud.

7. Carefully remove the Rear Shroud from the machine. Place a standard screwdriver behind and near the middle of the Rear Shroud and gently pry until it releases. Then move the screwdriver to the bottom and gently pry until the Rear Shroud comes off.

8. Remove the indicated Caps from the machine.



If working on a Bowflex Max Trainer® M5 fitness machine, skip to Step 12.  
If working on a Bowflex Max Trainer® M3 fitness machine, continue to Step 9.

9. Using a #2 Phillips screwdriver, remove the securing screw from the Shifter Assembly on the Right Static Handlebar.

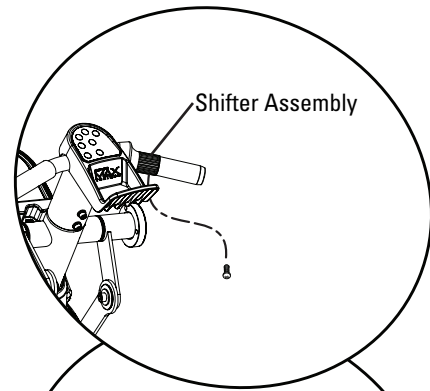

10. Remove the Cap and Hand Grip from the Right Static Handlebar and safely place outside the work area.

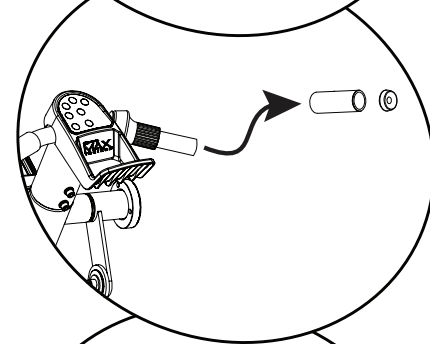

11. Slide the Shifter Assembly off of the Right Static Handlebar.

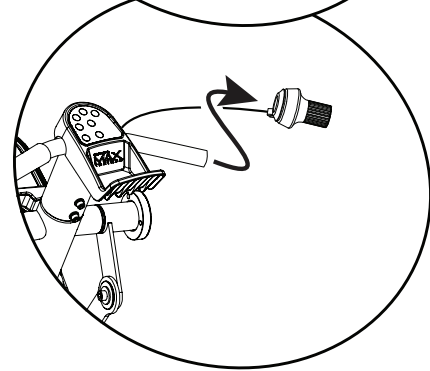

12. Using a 5mm hex wrench, remove the four indicated screws from the Static Handlebar Assembly.

13. Slightly remove the Static Handlebar Assembly and disconnect the cables. Carefully place the Static Handlebar Assembly outside the work area.

**Note:** Do not crimp the Console Cables.

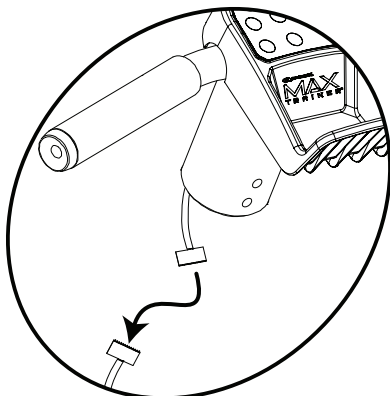

14. Using a #2 Phillips screwdriver, remove the 4 screws (2 on each side of the Shroud) from the Console Assembly.

**Note:** Be sure to save hardware for re-assembly since these are not included on the Hardware Card.



15. Carefully lift the Console Assembly and expose the Cable Connections.

**Note:** do not crimp any of the Console Cables.



16. Carefully disconnect the Cables noting their locations (see arrows).

**Note:** do not crimp any of the Console Cables.

17. Place the Console Assembly carefully out of the work area with the removed hardware.



18. Using an 8mm hex wrench, remove the indicated hardware from the Rail Assembly.



19. Using a 6mm hex wrench, remove the indicated hardware from the Rail Assembly. Be prepared to support the weight of the Rail Assembly.

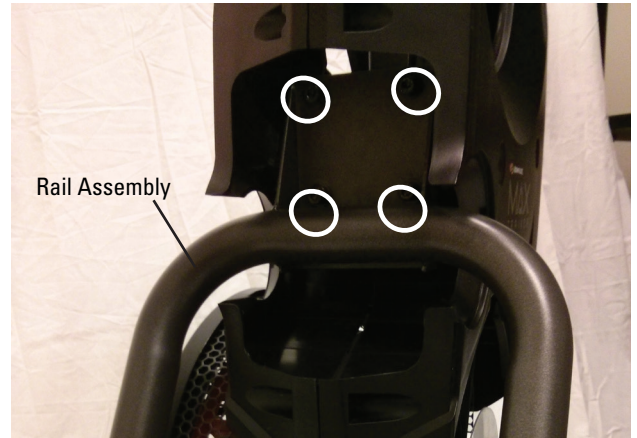

20. Using new Hardware Items C, N, and D, attach the Rail Assembly to the new Frame Assembly.

**!** Some components of the machine can be heavy or awkward. Use a second person when doing the assembly steps involving these parts. Do not do steps that involve heavy lifting or awkward movements on your own.

*NOTICE:* Hand tighten hardware.

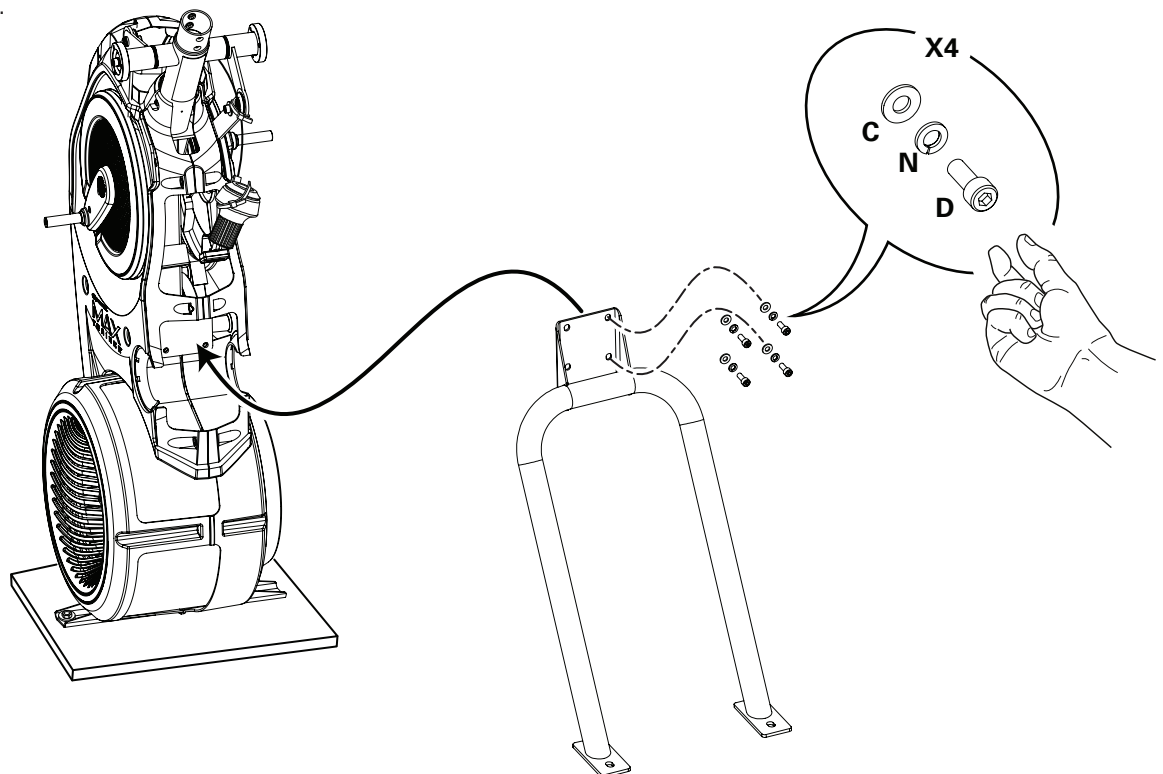

**!** A second person is recommended to stabilize the Frame Assembly.

21. Using an 8mm hex wrench, remove the indicated hardware from the old Frame Assembly. Be prepared to support the Frame Assembly before removing the hardware.

**!** The Frame Assembly may be awkward when released from the Stabilizer Assembly. Some components of the machine can be heavy or awkward. Use a second person to hold the Frame Assembly stable and upright. Do not do steps that involve heavy lifting or awkward movements on your own.

22. With the assistance of a second person, carefully lift the old Frame Assembly from the Stabilizer Assembly and place outside the assembly area. To protect your flooring, carefully place it onto its side on some cardboard or a blanket.

23. Using a 13mm wrench, remove the hardware that secures the new Frame Assembly to the shipping plate.

24. Carefully Lift the new Frame Assembly and Attach It to the Stabilizer Assembly

**!** Some components of the machine can be heavy or awkward. Use a second person when doing the assembly steps involving these parts. Do not do steps that involve heavy lifting or awkward movements on your own. Lift the Frame Assembly from the exterior of the pivot assembly as indicated below.

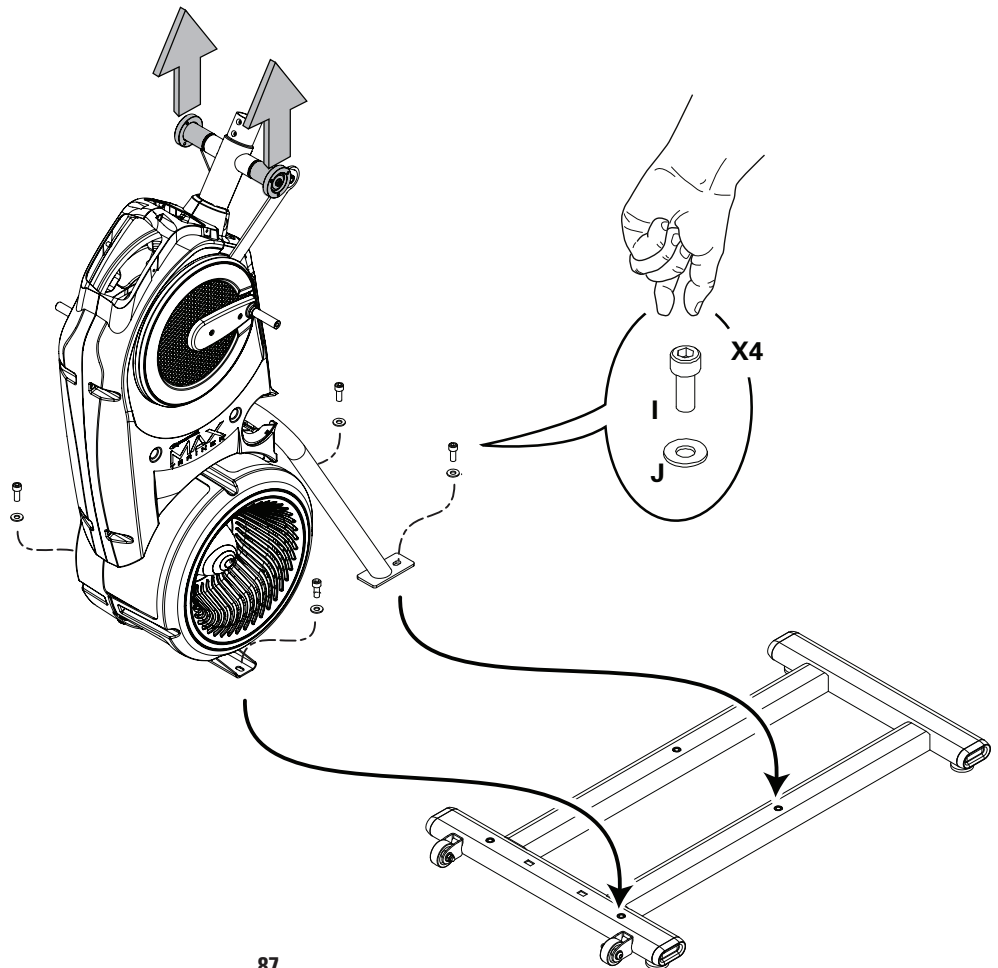
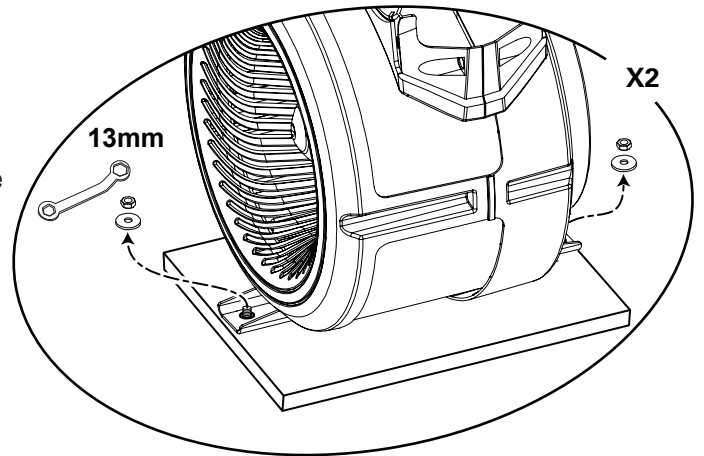

25. Fully tighten the hardware that attaches the Rail Assembly to the new Frame Assembly (from Step 16), and then the hardware just installed to the Stabilizer Assembly.

26. Reconnect the cables from the Console Assembly, and attach it to the Frame Assembly with a #2 Phillips screwdriver.

27. Cut the Shipping Zip-Ties and Attach the Rear Shroud and Caps to the Frame Assembly

**NOTICE:** Place the inside hook of the Rear Shroud on the Frame Assembly and then pivot it up into place.

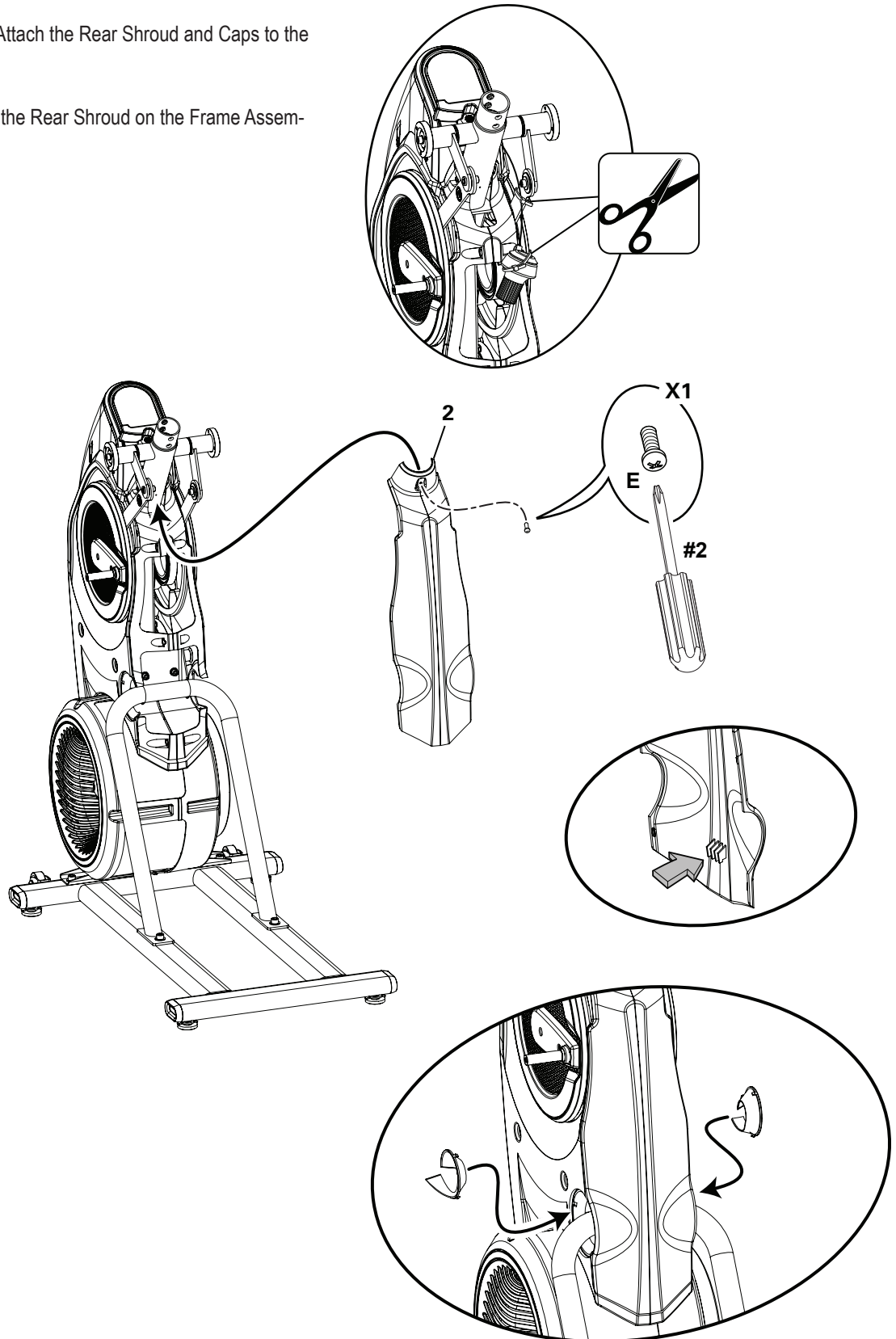



28. Attach Leg Assemblies to Frame Assembly

 Be aware that the Legs are connected and when either of these parts move the other does as well.

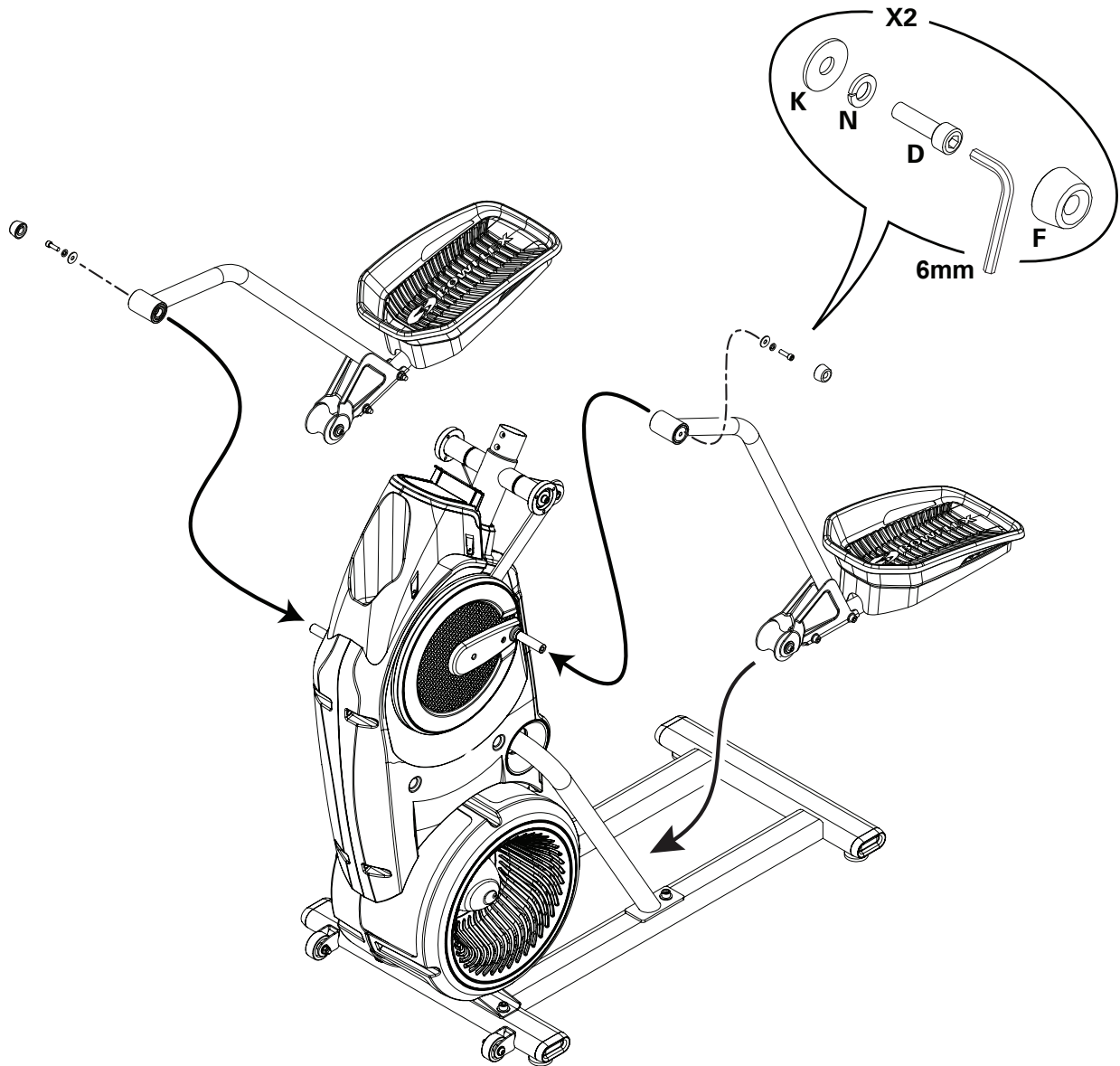

## 29. Attach the Upper Handlebars to Frame Assembly

**!** Be aware that the Pedals and the Upper Handlebars are connected and when either of these parts move the other does as well.

Some components of the machine can be heavy or awkward. Use a second person when doing the assembly steps involving these parts. Do not do steps that involve heavy lifting or awkward movements on your own.

*NOTICE:* Be sure to attach the Upper Handlebars so they can be correctly grasped by a User when on the machine.

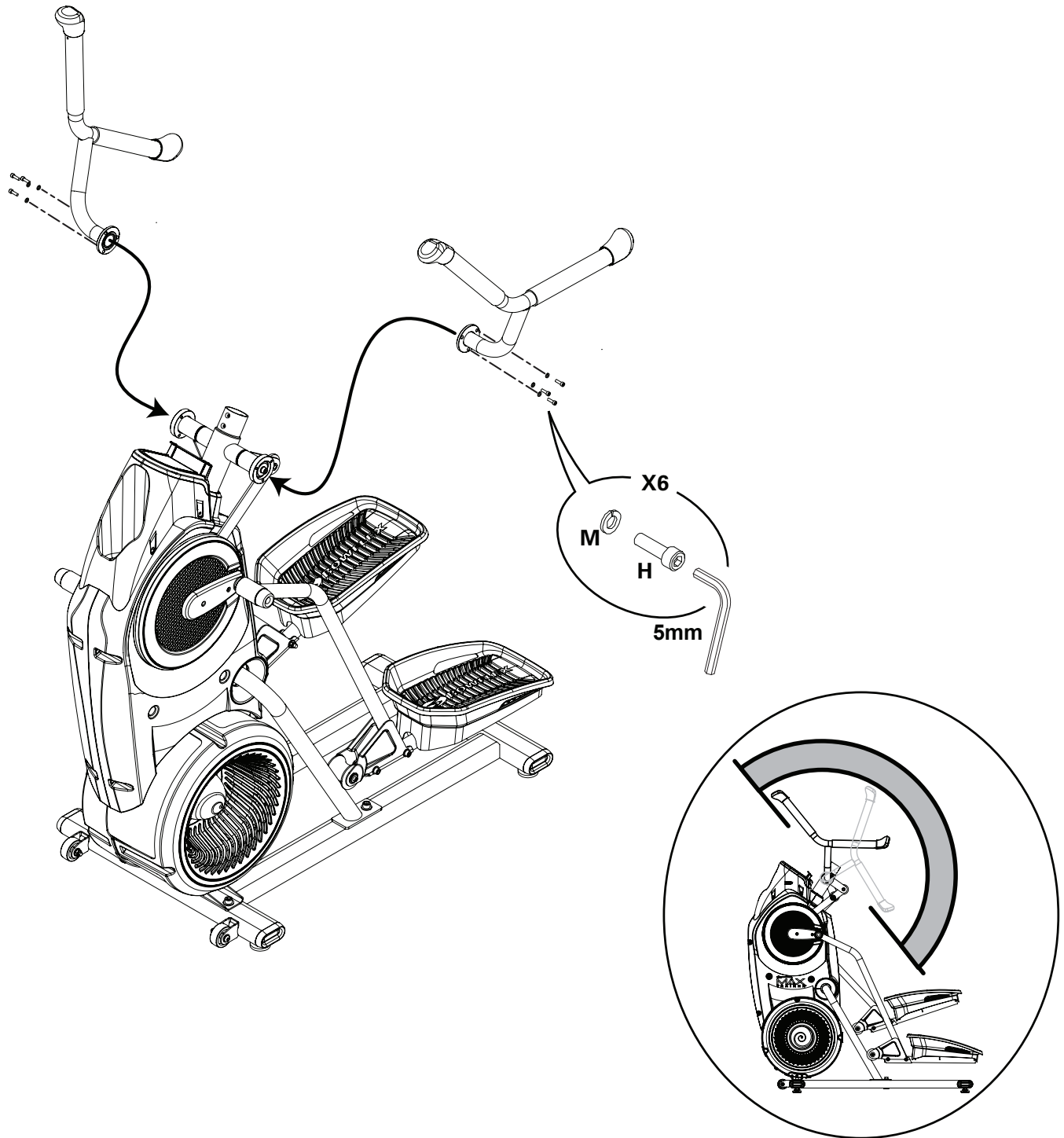

30. Connect the Static Handlebar Assembly to the Frame Assembly

**NOTICE:** Do not crimp the Console Cable.

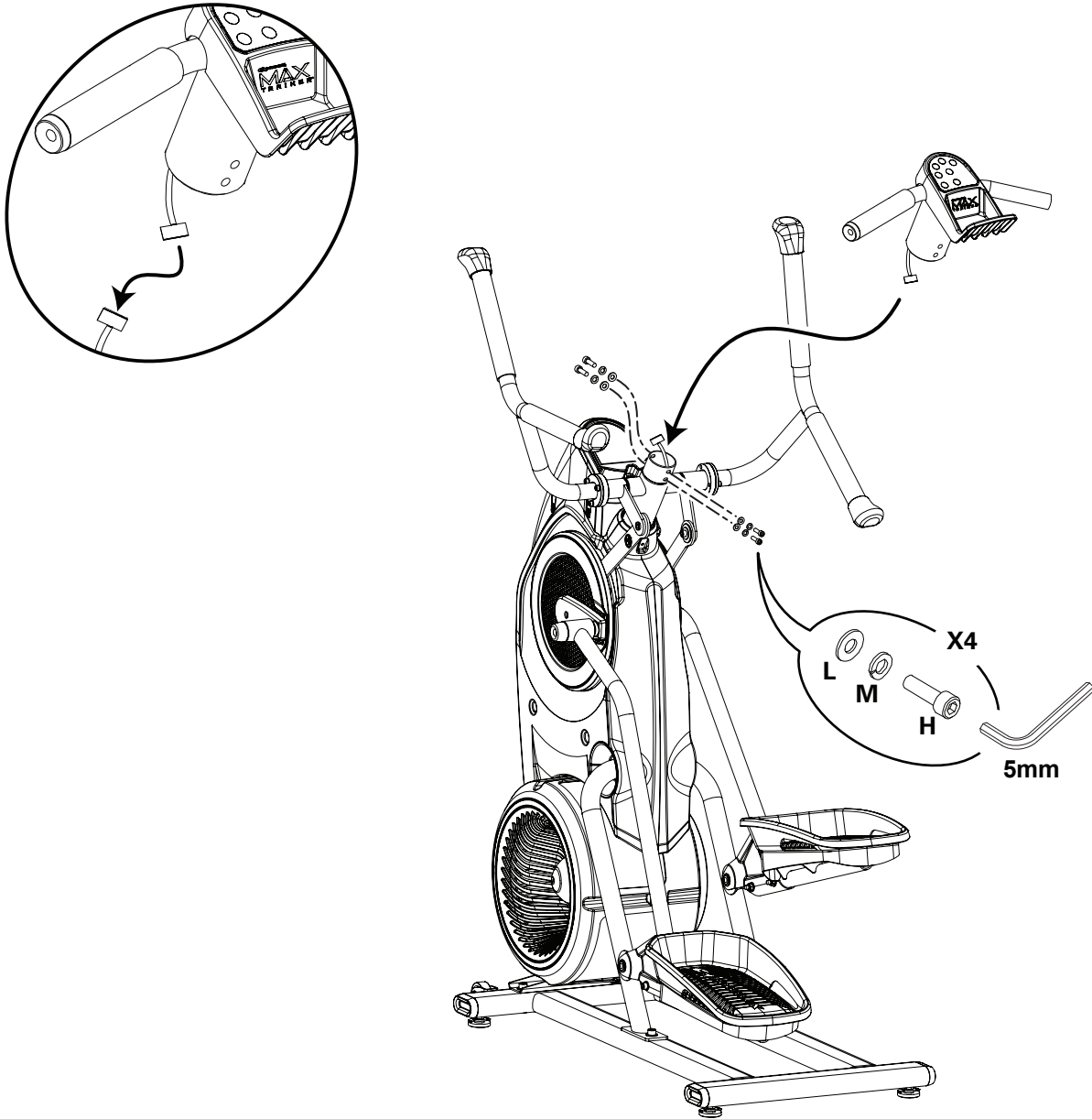

31. Attach the Shifter Assembly to the Static Handlebar and Attach the Grip

**NOTICE:** Do not crimp the Cable. Hardware is pre-installed and not on Hardware Card (\*). Be sure the settings on the Shifter Assembly are visible to a User before fully tightening the hardware.

**Note:** A small application of soapy water can be used to ease the Static Handlebar Grip onto the Handlebar.

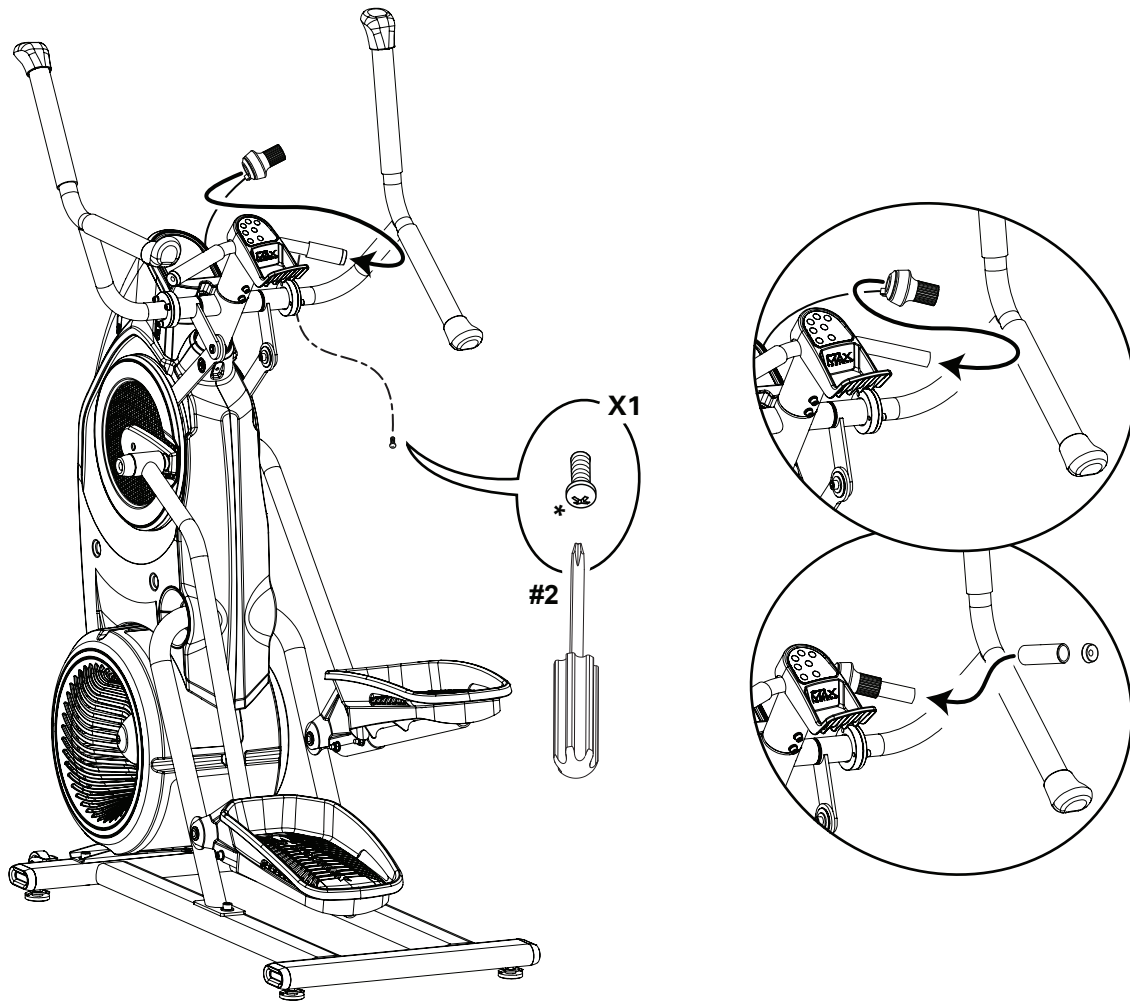

32. Final Inspection

Inspect your machine to ensure that all hardware is tight and components are properly assembled.



**Do not use until the machine has been fully assembled and inspected for correct performance in accordance with the Owner's Manual.**

**NOTICE:** This document provides instructions for the replacement of the I/O Cable on the Bowflex Max Trainer® M3 / M5.

If you need assistance, please call Bowflex Customer Service at 1-800-605-3369.

This icon means a potentially hazardous situation which, if not avoided, could result in death or serious injury. Read and understand all Warnings on this machine.

Nautilus, Inc., (800) NAUTILUS / (800) 628-8458, www.NautilusInc.com - Customer Service: North America (800) 605-3369, csnls@nautilus.com | outside U.S. www.nautilusinternational.com | Printed in China | © 2017 Nautilus, Inc. | ® indicates trademarks registered in the United States. These marks may be registered in other nations or otherwise protected by common law. Bowflex, the B logo, and Bowflex Max Trainer are trademarks owned by or licensed to Nautilus, Inc.

### Important Safety Instructions - Before servicing or using this equipment, obey the following warnings:

This icon means a potentially hazardous situation which, if not avoided, could result in death or serious injury. Read and understand all Warnings on this machine.

- Read and understand the Part Replacement Procedure before working on the machine. Failure to obey the instructions and safety warnings could cause injury to the service technician or bystanders.
- Keep bystanders and children away from the product being serviced at all times.
- Make sure that the repair is done in an appropriate work space away from foot traffic and exposure to bystanders.
- Disconnect all power to the machine before you service it.
- Some components of the equipment can be heavy or awkward. Enlist the service of a second person when you do maintenance steps involving these components. Do not try to do heavy or awkward steps on your own.
- If replacement parts are necessary, use only genuine Nautilus replacement parts and hardware. Failure to use genuine replacement parts can cause a risk to users, keep the machine from operating correctly and will void the warranty.
- Be sure that all warning stickers and instructional placards applied to the product stay present and in good condition when doing maintenance or replacing components. If necessary request replacement warning stickers or placards from Nautilus customer service.
- Do not try to change the design or functionality of the machine being serviced as this can adversely effect user safety and will void the warranty.
- Do not use the machine until all shrouds, instructions, warning labels and correct functionality have been verified and tested for correct performance.

### Tools Required (not included)

#2 Phillips screwdriver

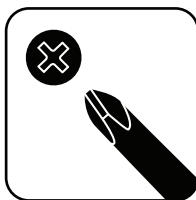

#2 Standard screwdriver

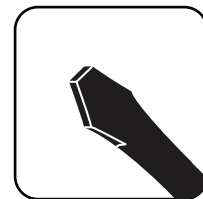

6mm hex wrench



(3) Replacement Zip-Ties

Something to cut Zip-Ties

10mm wrench



**Note:** The Bowflex Max Trainer® M3 is used in the following images. The procedure is the same for the M5 model.

1. Unplug the AC Adapter from the wall outlet and machine.
2. Using a #2 Phillips screwdriver, remove the 4 screws (2 indicated on one side) from the Console Assembly.



3. Carefully lift the Console Assembly and expose the Cable Connections.



4. Carefully disconnect the Cables noting their locations.

**Note:** Do not crimp any of the Console Cables.

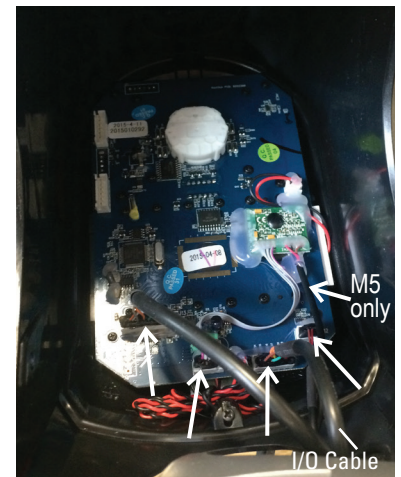

5. Using a 5mm hex wrench, remove the indicated hardware from the Right Upper Handlebar.

**Note:** Be aware that the Right Upper Handlebar must be supported when removing the hardware.



6. Using a #2 Phillips screwdriver, remove the indicated (by ovals) screws and only loosen the lowest indicated screw (arrow) from the Right Fan Cover.



7. The Right Fan Cover has a tab that needs to be pushed upward to clear the loosened screw. While pushing up on the tab, remove the Right Fan Cover from the assembly.

**Note:** the AC Power Cable is attached to the inside of the Right Fan Cover. Be sure not to crimp the cable by placing the Right Fan Cover close to the front of the machine.

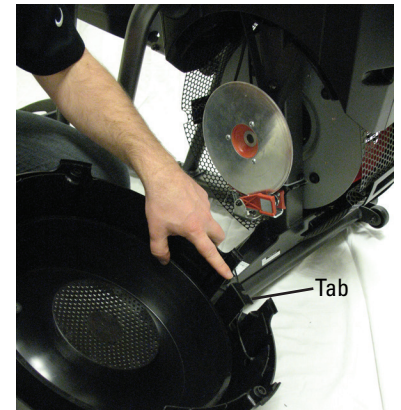
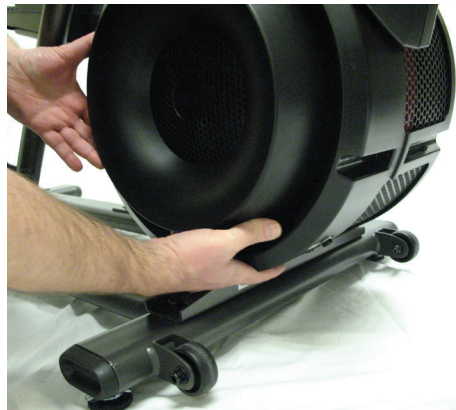

8. Remove the indicated Cap from the right side of the machine.

9. Using a 6mm hex wrench, remove the hardware exposed from below the Cap from the machine.

10. Slide the Leg Assembly off of the machine.



11. Using a #2 Phillips screwdriver, remove the indicated screw from the Rear Shroud.

12. Carefully remove the Rear Shroud from the machine. Place a standard screwdriver behind and near the middle of the Rear Shroud and gently pry until it releases. Then move the screwdriver to the bottom and gently pry until the Rear Shroud comes off.

13. Remove the indicated Caps from the machine.

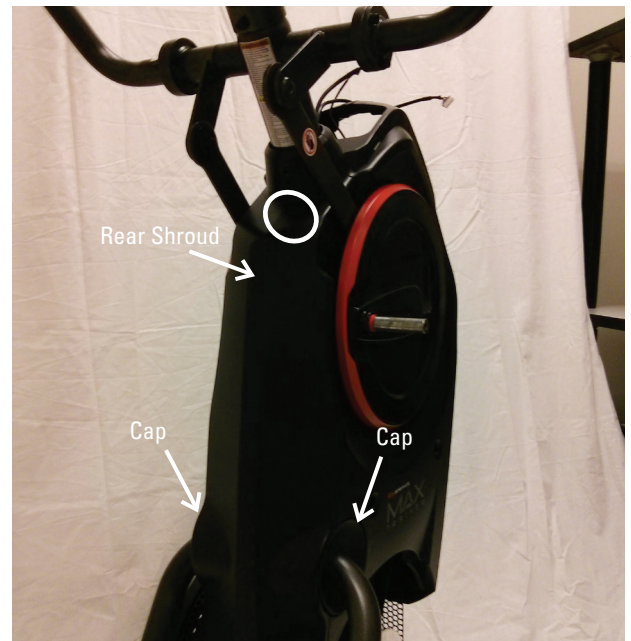

14. Using a #2 Phillips screwdriver, remove the 2 indicated screws from the Right Crank Cover.

15. Remove the Right Crank Cover from the machine.

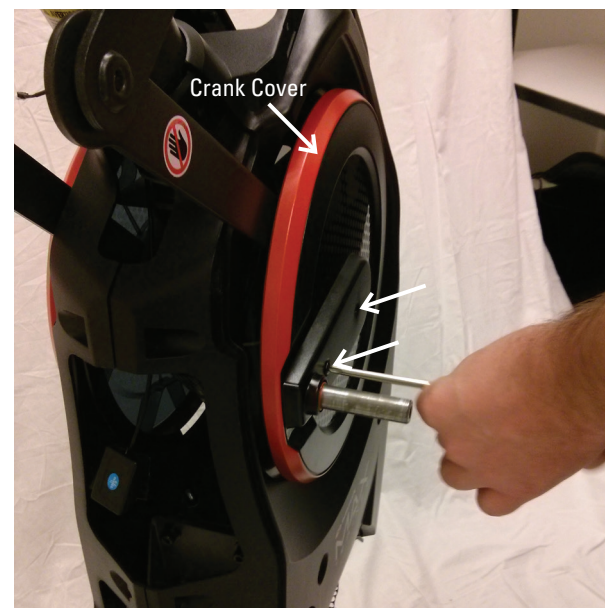



16. Place a rag or protective material below the Right Connector Arm to protect the Shrouds from potential scratches from the Connector Arms.

**Note:** The image shows the Left Connector Arm.

17. Using a 6mm hex wrench, remove the hardware that connects the Right Connector Arm and Pivot Arm.

**Note:** The Connector Arm will pivot downward if not lowered slowly onto the rag protecting the Shrouds

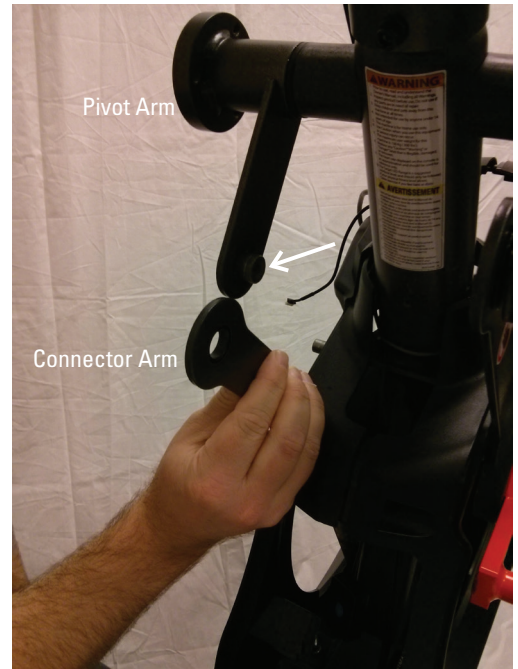

18. Using a #2 Phillips screwdriver, remove the screws from the Right Shroud. ( 3 screws on the Right Shroud) Remove the upper screws labeled ' \* ' last.

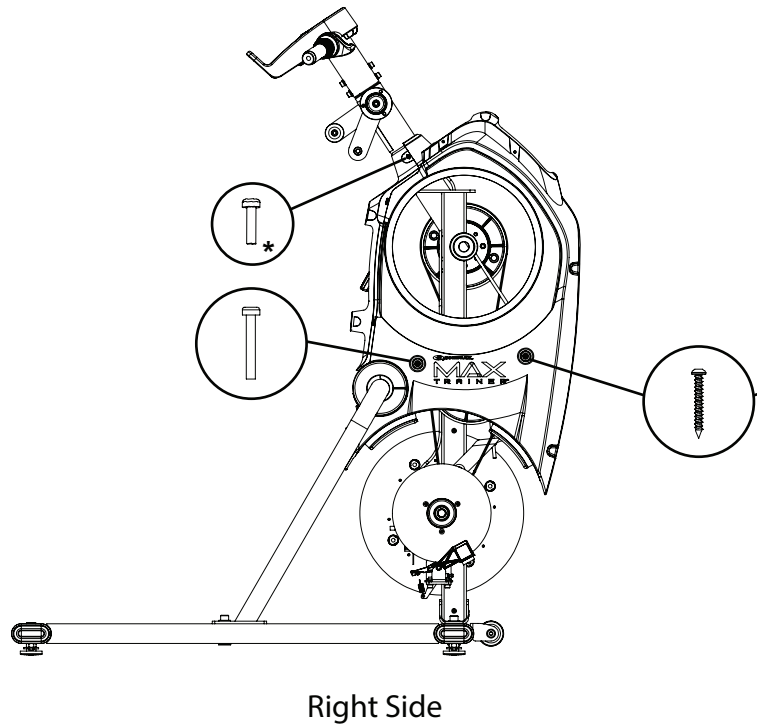

**Note:** Shrouds are removed for clarity.

19. Note how each of the three Zip-Ties secure the Cables to the Frame.

20. Starting with the Lower Zip-Tie, cut it without damaging the Cables.

21. Disconnect all the Cables that connect to the lower part of the I/O Cable.

22. With the new I/O Cable in place of the old I/O Cable, secure the Cables to the Frame with a replacement Zip-Tie. Be sure that the new I/O Cable is placed with the same length and end as the old I/O Cable.

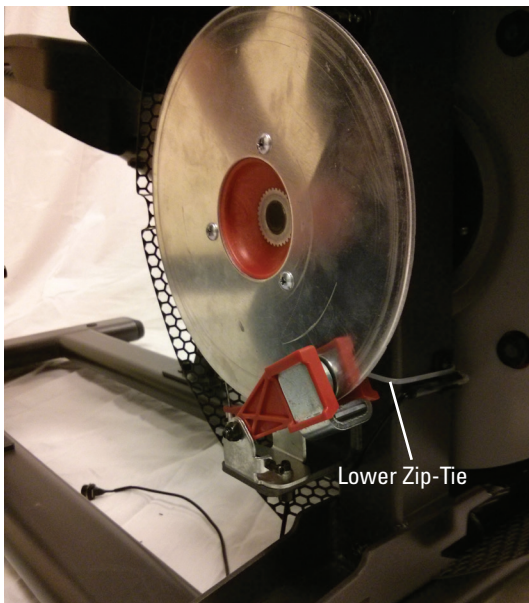

23. Cut the Middle Zip-Tie. Remove the old I/O Cable from the bundle and replace with the new I/O Cable.

24. Secure the Cables with a replacement Middle Zip-Tie.

25. Cut the Upper Zip-Tie and remove the old I/O Cable from the bundle. Replace with the new I/O Cable, and secure the Cables with a replacement Upper Zip-Tie.

26. Connect all the Cables to the new I/O Cable near the Lower Zip-Tie.

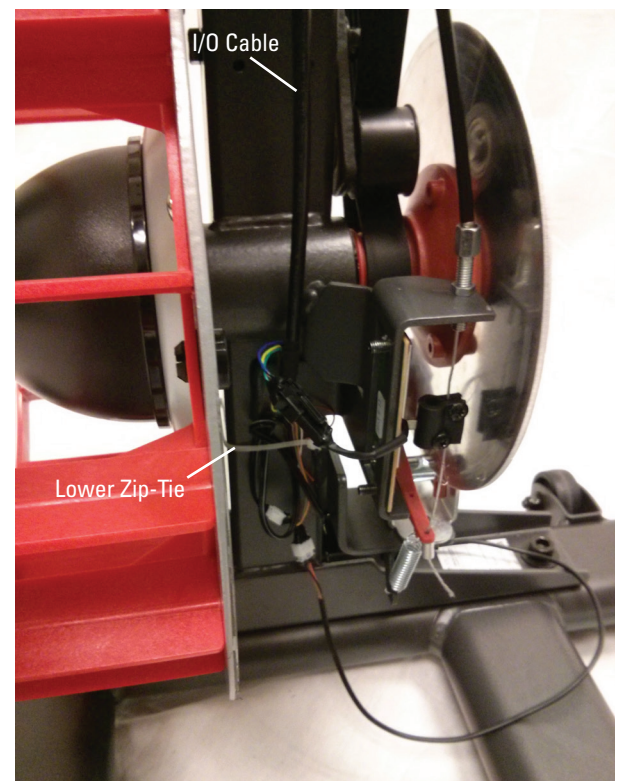

27. Re-assemble the machine in the reverse order of when the parts were removed.

28. Final Inspection

Inspect your machine to ensure that all hardware is tight and components are properly assembled.



**Do not use until the machine has been fully assembled and inspected for correct performance in accordance with the Owner's Manual.**

**NOTICE:** This document provides instructions for the replacement of the Keypad Assembly on the Bowflex Max Trainer® M3 / M5.

If you need assistance, please call **Bowflex Customer Service at 1-800-605-3369.**

 **This icon means a potentially hazardous situation which, if not avoided, could result in death or serious injury. Read and understand all Warnings on this machine.**

Nautilus, Inc., (800) NAUTILUS / (800) 628-8458, www.NautilusInc.com - Customer Service: North America (800) 605-3369, csnls@nautilus.com | outside U.S. www.nautilusinternational.com | Printed in China | © 2017 Nautilus, Inc. | ® indicates trademarks registered in the United States. These marks may be registered in other nations or otherwise protected by common law. Bowflex, the B logo, and Bowflex Max Trainer are trademarks owned by or licensed to Nautilus, Inc.

### Important Safety Instructions - Before servicing or using this equipment, obey the following warnings:

 **This icon means a potentially hazardous situation which, if not avoided, could result in death or serious injury. Read and understand all Warnings on this machine.**

- Read and understand the Part Replacement Procedure before working on the machine. Failure to obey the instructions and safety warnings could cause injury to the service technician or bystanders.
- Keep bystanders and children away from the product being serviced at all times.
- Make sure that the repair is done in an appropriate work space away from foot traffic and exposure to bystanders.
- Disconnect all power and allow to sit for 5 minutes before you service this machine.
- Some components of the equipment can be heavy or awkward. Enlist the service of a second person when you do maintenance steps involving these components. Do not try to do heavy or awkward steps on your own.
- If replacement parts are necessary, use only genuine Nautilus replacement parts and hardware. Failure to use genuine replacement parts can cause a risk to users, keep the machine from operating correctly and will void the warranty.
- Be sure that all warning stickers and instructional placards applied to the product stay present and in good condition when doing maintenance or replacing components. If necessary request replacement warning stickers or placards from Nautilus customer service.
- Do not try to change the design or functionality of the machine being serviced as this can adversely effect user safety and will void the warranty.
- Do not use the machine until all shrouds, instructions, warning labels and correct functionality have been verified and tested for correct performance.

### Tools Required (not included)

#2 Phillips screwdriver

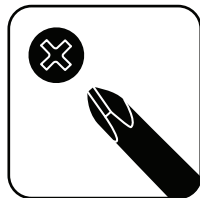

5mm hex wrench



**Note:** The Bowflex Max Trainer® M3 is used in the following images.

1. Unplug the AC Adapter from the wall outlet and machine.



2. Using a 5mm hex wrench, remove the 4 screws from the Static Handlebar Assembly.

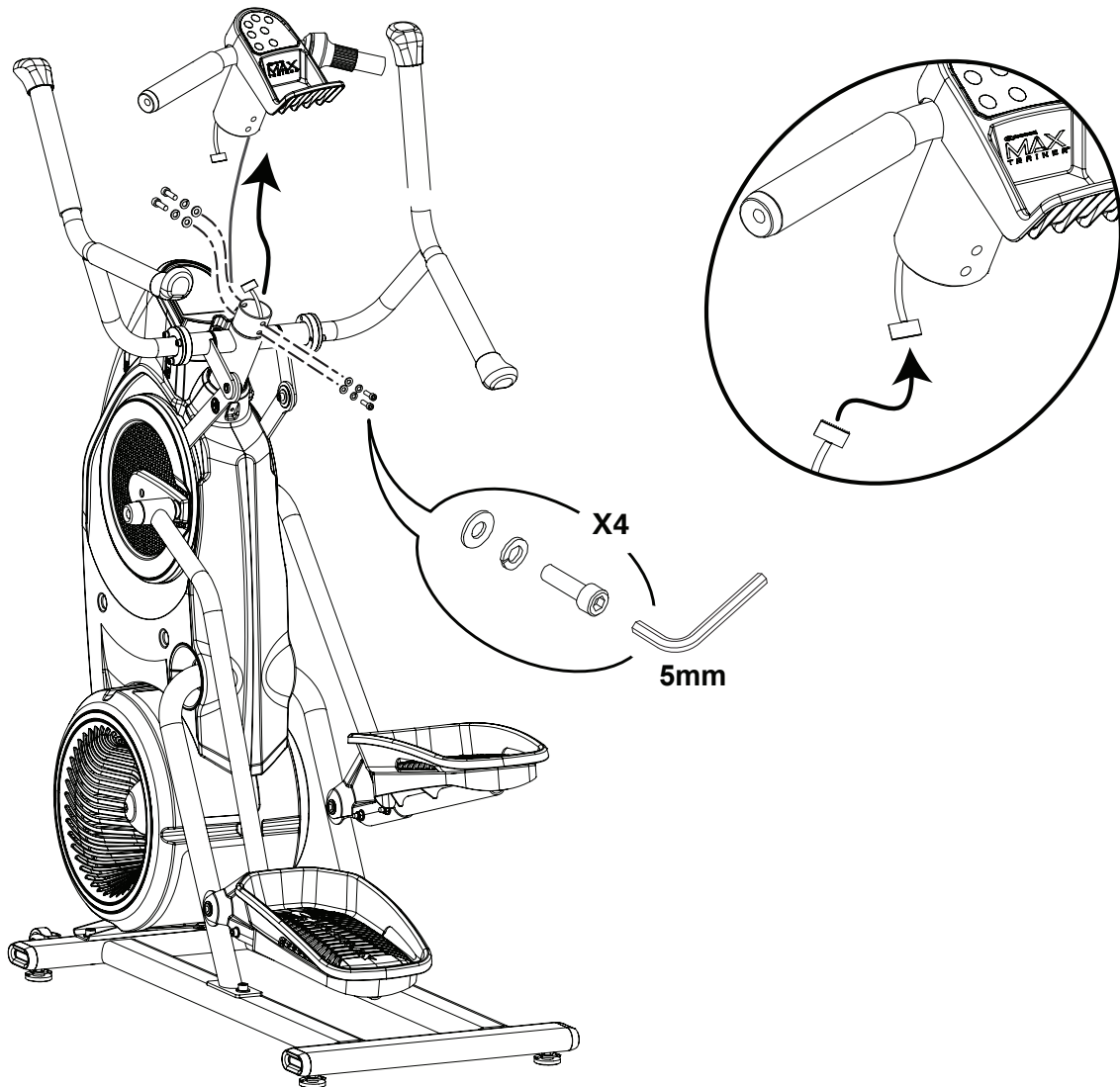

3. Carefully lift the Console Assembly and expose the Cable Connections and disconnect them.

**Note:** Do not crimp any of the Console Cables.

On the M3 machine be sure not to stretch, crimp, or damage the cable that runs from the Frame Assembly to the Shifter Assembly.

4. Using a #2 Phillips screwdriver, remove the 4 indicated screws that secures the Keypad Assembly to the Static Handlebars.

**Note:** Observe how the cable routes through the Static Handlebar from the Keypad Assembly to assist with re-assembly.

5. Remove the old Keypad Assembly and replace with the new one, correctly outing the cable through the Static Handlebars.

6. Re-assemble the machine in the reverse order of when the parts were removed.

7. Final Inspection

Inspect your machine to ensure that all hardware is tight and components are properly assembled.

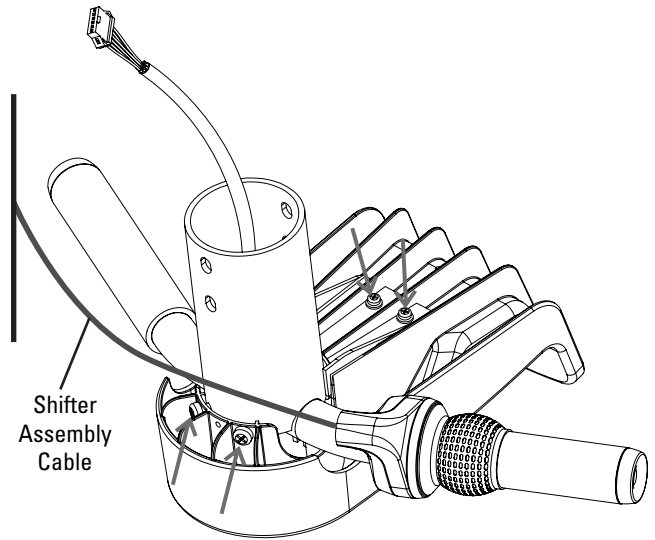

**Do not use until the machine has been fully assembled and inspected for correct performance in accordance with the Owner's Manual.**

**NOTICE:** This document provides instructions for the replacement of the Pivot Arms on the Bowflex Max Trainer® M3 / M5.

If you need assistance, please call **Bowflex Customer Service at 1-800-605-3369.**

 This icon means a potentially hazardous situation which, if not avoided, could result in death or serious injury. Read and understand all Warnings on this machine.

Nautilus, Inc., (800) NAUTILUS / (800) 628-8458, www.NautilusInc.com - Customer Service: North America (800) 605-3369, csnl@nautilus.com | outside U.S. www.nautilusinternational.com | Printed in China | © 2017 Nautilus, Inc. | ® indicates trademarks registered in the United States. These marks may be registered in other nations or otherwise protected by common law. Bowflex, the B Logo, and Bowflex Max Trainer are trademarks owned by or licensed to Nautilus, Inc.

### Important Safety Instructions - Before servicing or using this equipment, obey the following warnings:

 This icon means a potentially hazardous situation which, if not avoided, could result in death or serious injury. Read and understand all Warnings on this machine.

- Read and understand the Part Replacement Procedure before working on the machine. Failure to obey the instructions and safety warnings could cause injury to the service technician or bystanders.
- Keep bystanders and children away from the product being serviced at all times.
- Make sure that the repair is done in an appropriate work space away from foot traffic and exposure to bystanders.
- Disconnect all power and allow to sit for 5 minutes before you service this machine.
- Some components of the equipment can be heavy or awkward. Enlist the service of a second person when you do maintenance steps involving these components. Do not try to do heavy or awkward steps on your own.
- If replacement parts are necessary, use only genuine Nautilus replacement parts and hardware. Failure to use genuine replacement parts can cause a risk to users, keep the machine from operating correctly and will void the warranty.
- Be sure that all warning stickers and instructional placards applied to the product stay present and in good condition when doing maintenance or replacing components. If necessary request replacement warning stickers or placards from Nautilus customer service.
- Do not try to change the design or functionality of the machine being serviced as this can adversely effect user safety and will void the warranty.
- Do not use the machine until all shrouds, instructions, warning labels and correct functionality have been verified and tested for correct performance.

### Tools Required (not included)

#2 Phillips screwdriver



5mm hex wrench  
6mm hex wrench  
8mm hex wrench



**Note:** The Bowflex Max Trainer® M3 is used in the following images. The procedure is the same for the M5 model.

1. Unplug the AC Adapter from the wall outlet and machine.

1. From the side with the Crank Arm that needs to be replaced, remove the indicated Cap.

**Note:** The following photos show the removal of the Left Crank Arm.

2. Using a 6mm hex wrench, remove the hardware exposed from below the Cap.

3. Lift the Foot Pedal and slide the Leg Assembly straight off the machine. Be sure to pull straight out, or the Leg Assembly may be difficult to remove.

**Note:** A rubber mallet may be necessary if the Leg Assembly will not slide off.



4. Using a 5mm hex wrench, remove the indicated hardware from the Upper Handlebar.

**Note:** Be aware that the Upper Handlebar must be supported when removing the hardware.



5. Using a #2 Phillips screwdriver, remove the 2 indicated screws from the Crank Cover.

**Note:** The image displays the Right Crank Cover being removed.

6. Remove the Crank Cover from the machine.

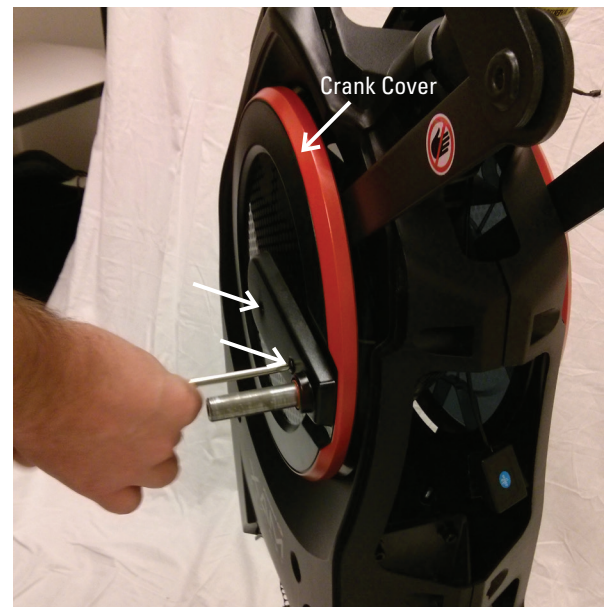



7. Place a rag or protective material below the Connector Arm to protect the Shrouds from potential scratches from the Connector Arms.

8. Using a 6mm hex wrench, remove the hardware that connects the Connector Arms and the Pivot Arms.

**Note:** The Connector Arm will pivot downward if not lowered slowly onto the rag protecting the Shrouds.

9. Using an 8mm hex wrench, remove the hardware that secures the Pivot Arm to the Frame Assembly.

10. Slide the old Pivot Arm off of the Pivot Rod and replace with the new one.

11. Re-assemble the machine in the reverse order of when the parts were removed.

12. If necessary, repeat the procedure to replace the other Pivot Arm.

13. Installation is the reverse procedure excluding steps with the Crank Puller. The Crank Puller is not required for re-assembly.

#### 14. Final Inspection

Inspect your machine to ensure that all hardware is tight and components are properly assembled.

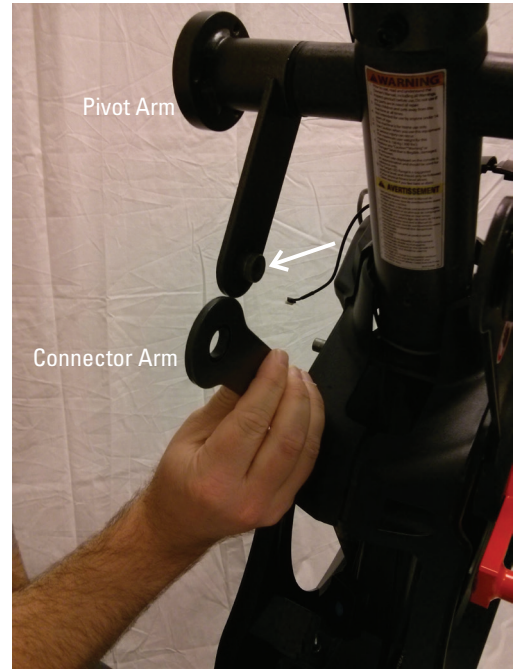

**Do not use until the machine has been fully assembled and inspected for correct performance in accordance with the Owner's Manual.**

**NOTICE:** This document provides instructions for the replacement of the Roller Wheel Assembly on the Bowflex Max Trainer® M3 / M5.

If you need assistance, please call Bowflex Customer Service at 1-800-605-3369.



This icon means a potentially hazardous situation which, if not avoided, could result in death or serious injury. Read and understand all Warnings on this machine.

Nautilus, Inc., (800) 605-3369, www.NautilusInc.com - Customer Service: North America (800) 605-3369, csnl@nautilus.com | outside U.S. www.nautilusinternational.com | Printed in China | © 2014 Nautilus, Inc. | ® indicates trademarks registered in the United States. These marks may be registered in other nations or otherwise protected by common law. Bowflex, the B logo, and Bowflex Max Trainer are trademarks owned by or licensed to Nautilus, Inc.

### Important Safety Instructions - Before servicing or using this equipment, obey the following warnings:



This icon means a potentially hazardous situation which, if not avoided, could result in death or serious injury. Read and understand all Warnings on this machine.

- Read and understand the Part Replacement Procedure before working on the machine. Failure to obey the instructions and safety warnings could cause injury to the service technician or bystanders.
- Keep bystanders and children away from the product being serviced at all times.
- Make sure that the repair is done in an appropriate work space away from foot traffic and exposure to bystanders.
- Disconnect all power and allow to sit for 5 minutes before you service this machine.
- Some components of the equipment can be heavy or awkward. Enlist the service of a second person when you do maintenance steps involving these components. Do not try to do heavy or awkward steps on your own.
- If replacement parts are necessary, use only genuine Nautilus replacement parts and hardware. Failure to use genuine replacement parts can cause a risk to users, keep the machine from operating correctly and will void the warranty.
- Be sure that all warning stickers and instructional placards applied to the product stay present and in good condition when doing maintenance or replacing components. If necessary request replacement warning stickers or placards from Nautilus customer service.
- Do not try to change the design or functionality of the machine being serviced as this can adversely effect user safety and will void the warranty.
- Do not use the machine until all shrouds, instructions, warning labels and correct functionality have been verified and tested for correct performance.

### Tools (not included)

(2) 6mm hex wrenches



1. Unplug the AC Power Adapter from the machine and wait 5 minutes.

2. Using two 6mm hex wrenches, remove the Roller Wheel Assembly from the Pedal Arm.

**⚠** In order to avoid possible serious injury when removing the Roller Wheel Assembly, be careful to avoid fingers or hands being caught or pinched.

**⚠** Be aware that the Pedal Arms and the Upper Handlebars are connected and when either of these parts move the other does as well.

3. Remove and dispose of the old Roller Wheel, Axle, Screws, and any Washers that were installed.

**Note:** Some Washers may stick to the Wheel Bracket on the Pedal Arm. Be sure to remove them before re-assembly.



4. Attach the new Roller Wheel Assembly with the provided hardware. The new Roller Wheel Assembly includes two Small Metal Washers and two Large Felt Washers. Make sure the Small Metal Washers are installed on the *outside* of the Wheel Brackets, while the Large Felt Washers are on the *inside* of the Wheel Bracket next to the Roller Wheel.

**Note:** The new washer configuration may differ from what was originally installed on the machine. The Wheel Bracket is sized so the Axle can only be inserted in one direction.

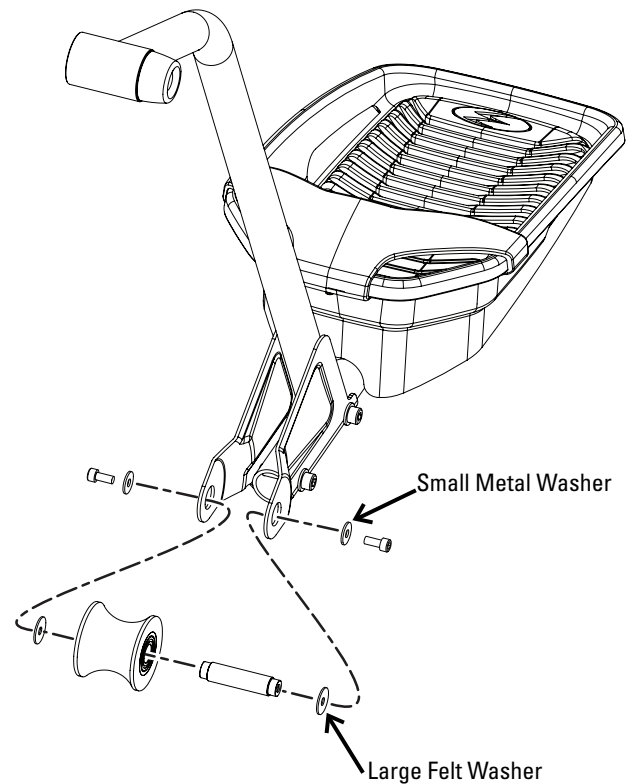
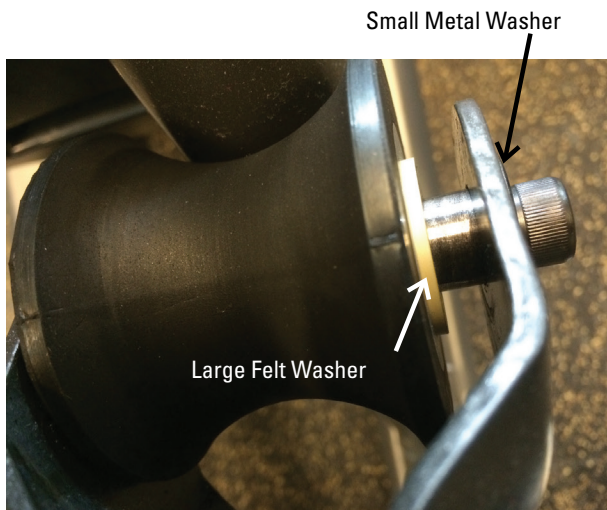

5. Final Inspection

Inspect your machine to ensure that all hardware is tight and components are properly assembled.

**⚠** Do not use until the machine has been fully assembled and inspected for correct performance in accordance with the Owner's Manual.

**NOTICE:** This document provides instructions for the replacement of a Self Tensioning Fan Belt on the Bowflex Max Trainer® M3 / M5.

If your machine has a Fan Belt Tensioner, it does not use a Self-Tensioning Belt. Please refer to the “Replace the Fan Belt on the Bowflex Max Trainer® M3 / M5” procedure instead.

**If you need assistance, please call Bowflex Customer Service at 1-800-605-3369.**

 **This icon means a potentially hazardous situation which, if not avoided, could result in death or serious injury. Read and understand all Warnings on this machine.**

Nautilus, Inc., (800) NAUTILUS / (800) 628-8458, www.NautilusInc.com - Customer Service: North America (800) 605-3369, csnls@nautilus.com | outside U.S. www.nautilusinternational.com | Printed in China | © 2014 Nautilus, Inc. | ® indicates trademarks registered in the United States. These marks may be registered in other nations or otherwise protected by common law. Bowflex, the B logo, and Bowflex Max Trainer are trademarks owned by or licensed to Nautilus, Inc.

### Important Safety Instructions - Before servicing or using this equipment, obey the following warnings:

 **This icon means a potentially hazardous situation which, if not avoided, could result in death or serious injury. Read and understand all Warnings on this machine.**

- Read and understand the Part Replacement Procedure before working on the machine. Failure to obey the instructions and safety warnings could cause injury to the service technician or bystanders.
- Keep bystanders and children away from the product being serviced at all times.
- Make sure that the repair is done in an appropriate work space away from foot traffic and exposure to bystanders.
- Disconnect all power and allow to sit for 5 minutes before you service this machine.
- Some components of the equipment can be heavy or awkward. Enlist the service of a second person when you do maintenance steps involving these components. Do not try to do heavy or awkward steps on your own.
- If replacement parts are necessary, use only genuine Nautilus replacement parts and hardware. Failure to use genuine replacement parts can cause a risk to users, keep the machine from operating correctly and will void the warranty.
- Be sure that all warning stickers and instructional placards applied to the product stay present and in good condition when doing maintenance or replacing components. If necessary request replacement warning stickers or placards from Nautilus customer service.
- Do not try to change the design or functionality of the machine being serviced as this can adversely effect user safety and will void the warranty.
- Do not use the machine until all shrouds, instructions, warning labels and correct functionality have been verified and tested for correct performance.

### Tools Required (not included)

#2 Phillips screwdriver

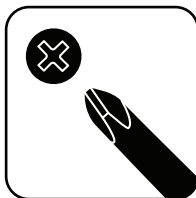

#2 Standard screwdriver

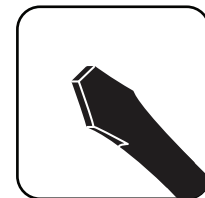

6mm hex wrench



Eye Protection

Wire Cutter



Heavy Duty Zip-Tie



**Note:** The Bowflex Max Trainer® M3 is used in the following images. The procedure is the same for the M5 model.

1. Unplug the AC Adapter from the machine and wait 5 minutes.
2. Using a #2 Phillips screwdriver, remove the 4 screws (2 indicated on one side) from the Console Assembly.



3. Carefully lift the Console Assembly and expose the Cable Connections.



4. Carefully disconnect the Cables noting their locations.

**Note:** do not crimp any of the Console Cables.

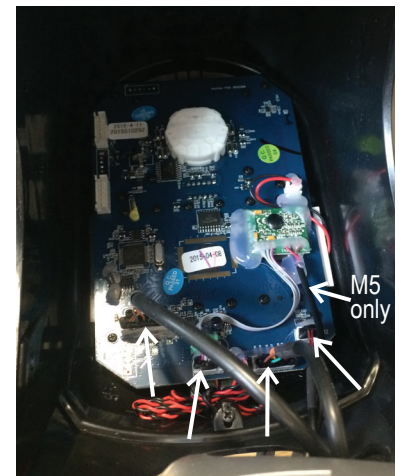

5. Using a 5mm hex wrench, remove the indicated hardware from the Upper Handlebars.

**Note:** Be aware that the Upper Handlebars must be supported when removing the hardware.



6. Using a #2 Phillips screwdriver, remove the indicated (by ovals) screws and only loosen the lowest indicated screw (arrow) from the Right Fan Cover.



7. The Right Fan Cover has a tab that needs to be pushed upward to clear the loosened screw. While pushing up on the tab, remove the Right Fan Cover from the assembly.

**Note:** the AC Power Cable is attached to the inside of the Right Fan Cover. Be sure not to crimp the cable by placing the Right Fan Cover close to the front of the machine.

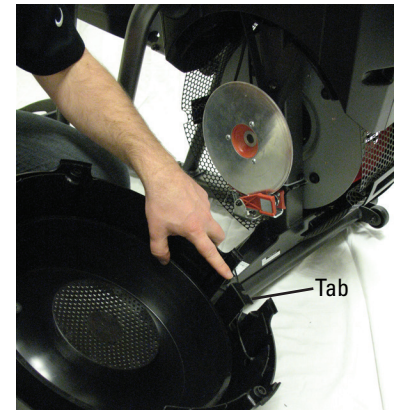
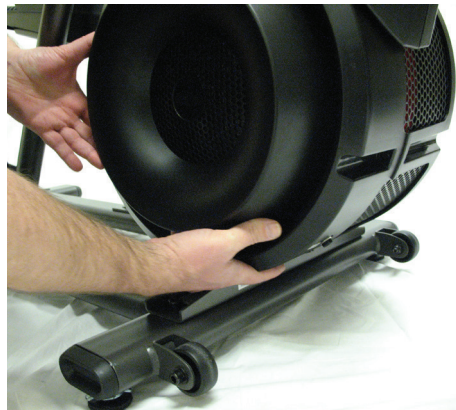

8. Remove the indicated Cap from both sides of the machine.

9. Using a 6mm hex wrench, remove the hardware exposed from below the Cap from both sides of the machine.

10. Slide the Leg Assemblies off of the machine.



11. Using a #2 Phillips screwdriver, remove the indicated screw from the Rear Shroud.

12. Carefully remove the Rear Shroud from the machine. Place a standard screwdriver behind and near the middle of the Rear Shroud and gently pry until it releases. Then move the screwdriver to the bottom and gently pry until the Rear Shroud comes off.

13. Remove the indicated Caps from the machine.

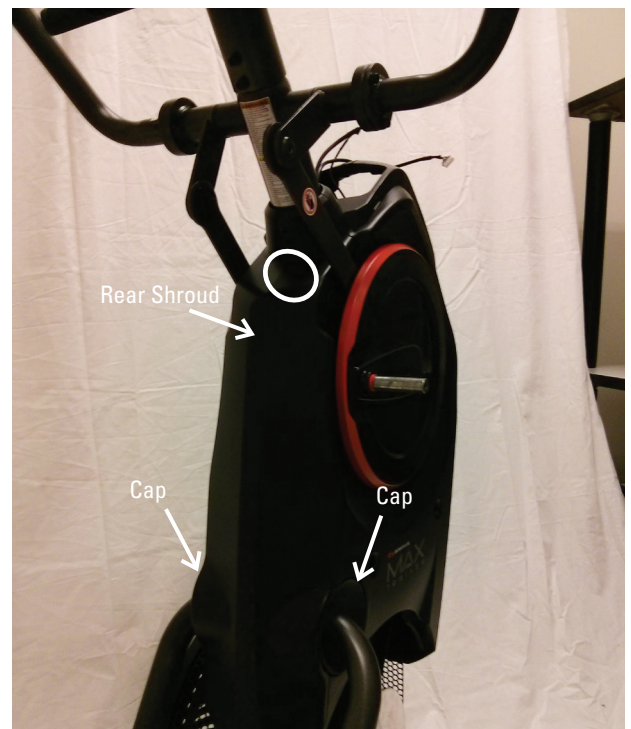

14. Using a #2 Phillips screwdriver, remove the indicated (by ovals) screws and only loosen the lowest indicated screw (arrow) from the Left Fan Cover.

15. The Left Fan Cover Assembly has a tab that needs to be pushed upward to clear the loosened screw. While pushing up on the tab, remove the Left Fan Cover Assembly.

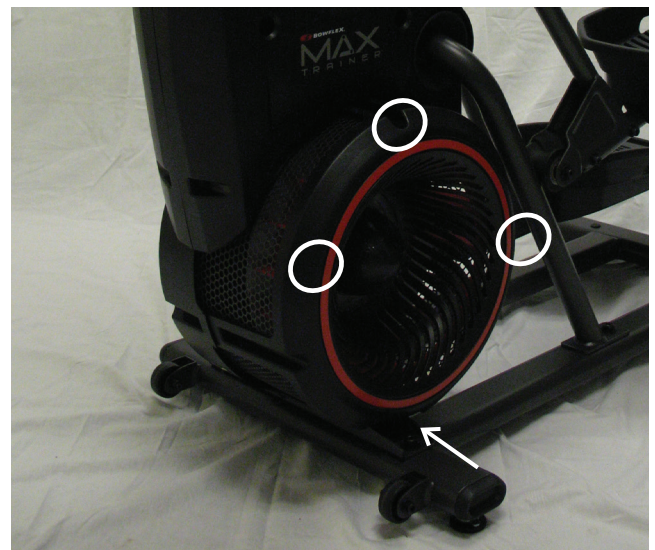

16. Remove the Left Fan Cover Assembly from the machine. Be sure to note how the fan screens are set into the Left Fan Cover to assist with the replacement procedure.

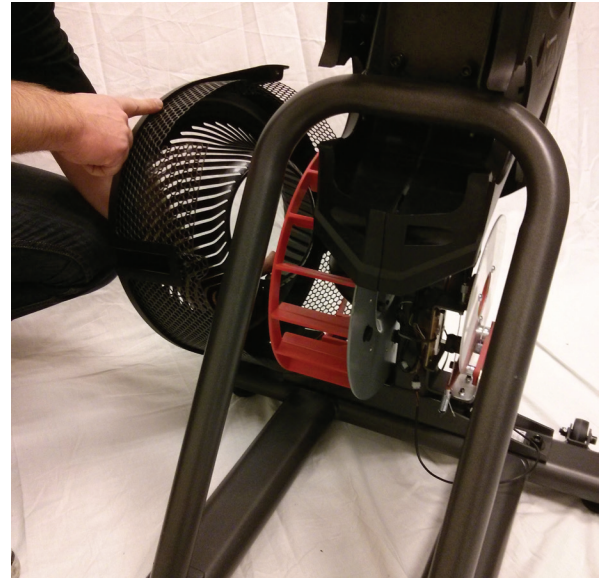

17. Using a #2 Phillips screwdriver, remove the 2 indicated screws from the Crank Cover. Repeat on the other side of the machine.

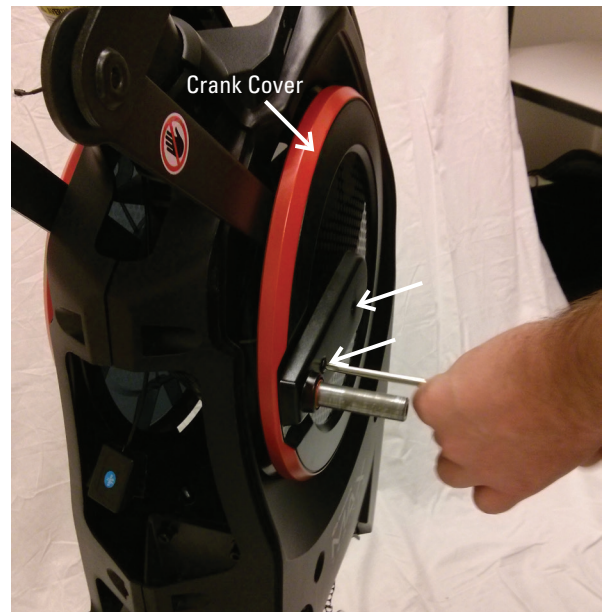

18. Remove the Crank Covers from the machine.

19. Place a rag or protective material below the Connector Arm to protect the Shrouds from potential scratches from the Connector Arms.

20. Using a 6mm hex wrench, remove the hardware that connects the Connector Arms and the Pivot Arms.

**Note:** The Connector Arm will pivot downward if not lowered slowly onto the rag protecting the Shrouds

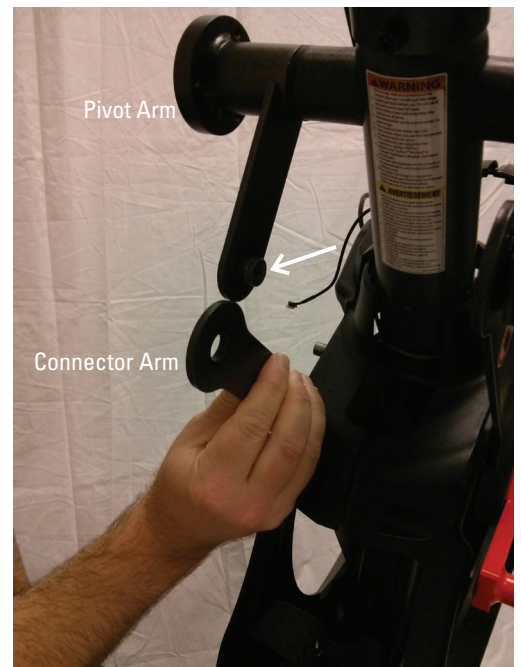



21. Using a #2 Phillips screwdriver, remove the screws from the Right and Left Shrouds. ( 3 screws on the Right Shroud, 9 on the Left Shroud) Remove the upper screws labeled ' \* ' last.

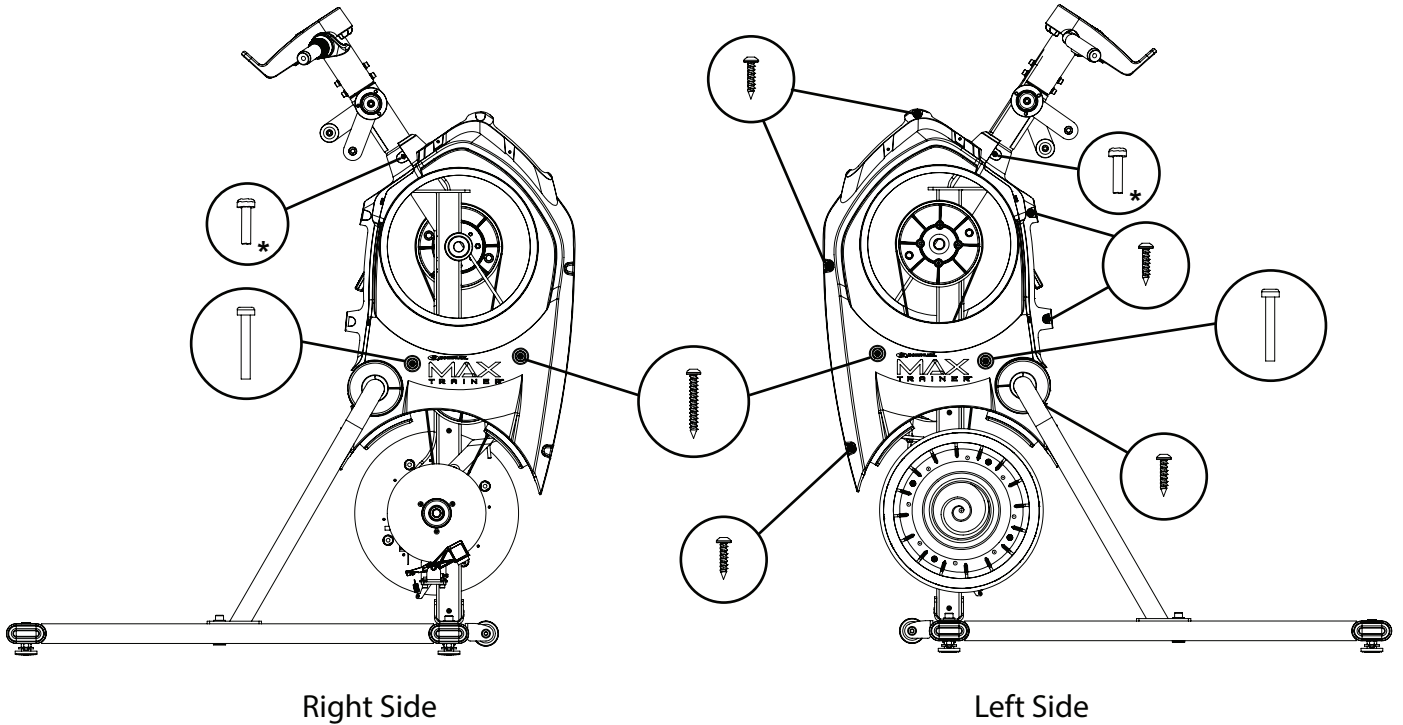

22. Place pieces of cardboard between the Brake Magnets and the Disc Brake.

23. Using a #2 Phillips screwdriver, remove the 3 indicated screws from the Disc Brake.

24. Carefully remove the Disc Brake from the machine exposing the lower Fan Belt.

25. Turn the Fan Pulley while forcing the Fan Belt to the outside. Belt will come off of the Fan Pulley.

 **Keep fingers out of any pinch opportunities when removing the Fan Belt.**

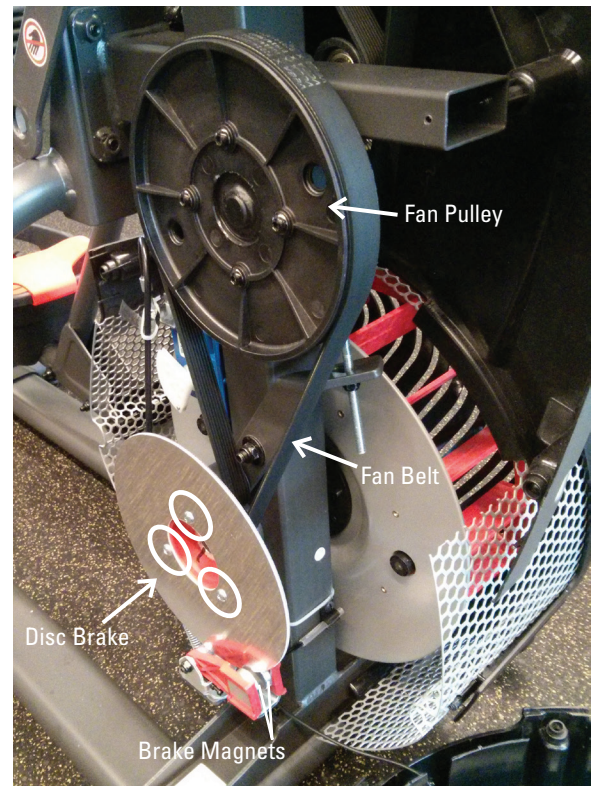

26. Loop the new Fan Belt around the lower Pulley and start it on the face of the Fan Pulley.

27. Be sure the Fan Belt is centered on both pulleys.



28. Secure the Fan Belt to the Fan Pulley with a Heavy Duty Zip-Tie. Be sure to attach the Zip-Tie where the Fan Belt is fully in contact with the Fan Pulley.

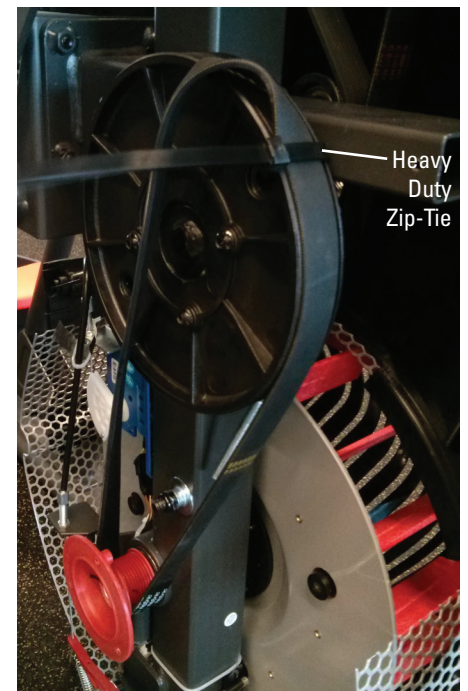

29. Grasp the Fan Pulley where the Fan Belt is engaged on it, and forcibly rotate the Fan Pulley until the Fan Belt is fully engaged.

 **Keep fingers out of any pinch opportunities when rotating the Fan Pulley.**

30. Put on eye protection and cut the Zip-Tie without damaging the new Fan Belt or Fan Pulley.

31. Installation is the reverse procedure.

32. Final Inspection  
Inspect your machine to ensure that all hardware is tight and components are properly assembled.

 **Do not use until the machine has been fully assembled and inspected for correct performance in accordance with the Owner's Manual.**



**NOTICE:** This document provides instructions for the replacement of the Servo Motor on the Bowflex Max Trainer® M5.

**If you need assistance, please call Bowflex Customer Service at 1-800-605-3369.**

 **This icon means a potentially hazardous situation which, if not avoided, could result in death or serious injury. Read and understand all Warnings on this machine.**

Nautilus, Inc., (800) NAUTILUS / (800) 628-8458, www.NautilusInc.com - Customer Service: North America (800) 605-3369, csnls@nautilus.com | outside U.S. www.nautilusinternational.com | Printed in China | © 2014 Nautilus, Inc. | ® indicates trademarks registered in the United States. These marks may be registered in other nations or otherwise protected by common law. Bowflex, the B logo, and Bowflex Max Trainer are trademarks owned by or licensed to Nautilus, Inc.

### Important Safety Instructions - Before servicing or using this equipment, obey the following warnings:

 **This icon means a potentially hazardous situation which, if not avoided, could result in death or serious injury. Read and understand all Warnings on this machine.**

- Read and understand the Part Replacement Procedure before working on the machine. Failure to obey the instructions and safety warnings could cause injury to the service technician or bystanders.
- Keep bystanders and children away from the product being serviced at all times.
- Make sure that the repair is done in an appropriate work space away from foot traffic and exposure to bystanders.
- Disconnect all power and allow to sit for 5 minutes before you service this machine.
- Some components of the equipment can be heavy or awkward. Enlist the service of a second person when you do maintenance steps involving these components. Do not try to do heavy or awkward steps on your own.
- If replacement parts are necessary, use only genuine Nautilus replacement parts and hardware. Failure to use genuine replacement parts can cause a risk to users, keep the machine from operating correctly and will void the warranty.
- Be sure that all warning stickers and instructional placards applied to the product stay present and in good condition when doing maintenance or replacing components. If necessary request replacement warning stickers or placards from Nautilus customer service.
- Do not try to change the design or functionality of the machine being serviced as this can adversely effect user safety and will void the warranty.
- Do not use the machine until all shrouds, instructions, warning labels and correct functionality have been verified and tested for correct performance.

### Tools Required (not included)

#2 Phillips screwdriver



1.5mm hex wrench  
5mm hex wrench



8mm wrench



1. Unplug the AC Adapter from the machine and wait 5 minutes.

2. Using a #2 Phillips screwdriver, remove the indicated (by ovals) screws and only loosen the lowest indicated screw (arrow) from the Right Fan Cover.

**Note:** Loosen the lowest screw by at least 3 full rotations.

3. The Right Fan Cover has a tab that needs to be pushed upward to clear the loosened screw. While pushing up on the tab, remove the Right Fan Cover from the assembly.

**Note:** the AC Power Cable is attached to the inside of the Right Fan Cover. Be sure not to crimp the cable by placing the Right Fan Cover close to the front of the machine.



4. Place pieces of cardboard between the Brake Magnets and the Disc Brake.

5. Using a #2 Phillips screwdriver, remove the 3 indicated screws from the Disc Brake.

6. Carefully remove the Disc Brake from the machine.

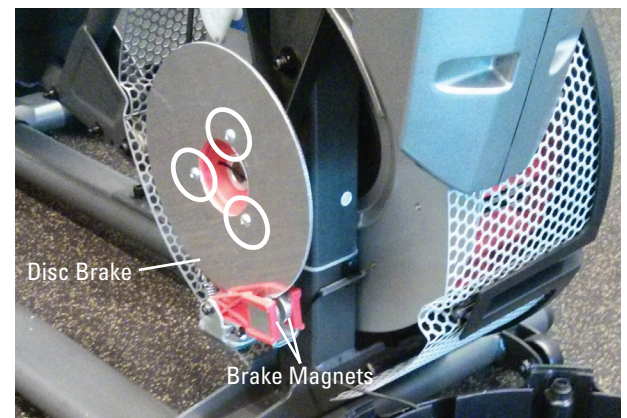

7. Using a 8mm open ended wrench, loosen the Brake Cable Securing Nut until the Brake Cable can be released from the Servo Motor Arm.

8. Remove the Brake Spring from the Brake Arm.

9. Disconnect the Connection Cables from the Servo Motor.

10. Using a #2 Phillips screwdriver, remove the 4 screws that attach the Servo Motor to the Frame.

11. Attach the new Servo Motor to the Frame

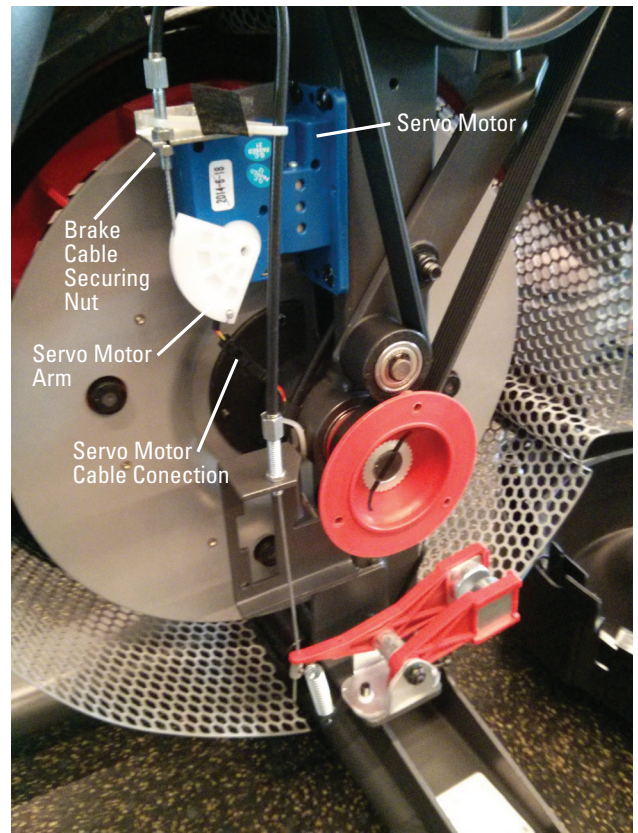

12. Installation is the reverse procedure.

13. Final Inspection

Inspect your machine to ensure that all hardware is tight and components are properly assembled.



**Do not use until the machine has been fully assembled and inspected for correct performance in accordance with the Owner's Manual.**

**NOTICE:** This document provides instructions for the replacement of the Shrouds on the Bowflex Max Trainer® M3 / M5.

**If you need assistance, please call Bowflex Customer Service at 1-800-605-3369.**

 **This icon means a potentially hazardous situation which, if not avoided, could result in death or serious injury. Read and understand all Warnings on this machine.**

Nautilus, Inc., (800) NAUTILUS / (800) 628-8458, www.NautilusInc.com - Customer Service: North America (800) 605-3369, csnls@nautilus.com | outside U.S. www.nautilusinternational.com | Printed in China | © 2014 Nautilus, Inc. | ® indicates trademarks registered in the United States. These marks may be registered in other nations or otherwise protected by common law. Bowflex, the B logo, and Bowflex Max Trainer are trademarks owned by or licensed to Nautilus, Inc.

### Important Safety Instructions - Before servicing or using this equipment, obey the following warnings:

 **This icon means a potentially hazardous situation which, if not avoided, could result in death or serious injury. Read and understand all Warnings on this machine.**

- Read and understand the Part Replacement Procedure before working on the machine. Failure to obey the instructions and safety warnings could cause injury to the service technician or bystanders.
- Keep bystanders and children away from the product being serviced at all times.
- Make sure that the repair is done in an appropriate work space away from foot traffic and exposure to bystanders.
- Disconnect all power and allow to sit for 5 minutes before you service this machine.
- Some components of the equipment can be heavy or awkward. Enlist the service of a second person when you do maintenance steps involving these components. Do not try to do heavy or awkward steps on your own.
- If replacement parts are necessary, use only genuine Nautilus replacement parts and hardware. Failure to use genuine replacement parts can cause a risk to users, keep the machine from operating correctly and will void the warranty.
- Be sure that all warning stickers and instructional placards applied to the product stay present and in good condition when doing maintenance or replacing components. If necessary request replacement warning stickers or placards from Nautilus customer service.
- Do not try to change the design or functionality of the machine being serviced as this can adversely effect user safety and will void the warranty.
- Do not use the machine until all shrouds, instructions, warning labels and correct functionality have been verified and tested for correct performance.

#### Tools Required (not included)

#2 Phillips screwdriver



6mm hex wrench



(if replacing Right Fan Cover)  
15mm wrench



**Note:** The Bowflex Max Trainer® M3 is used in the following images. The procedure is the same for the M5 model.

1. Unplug the AC Adapter from the machine and wait 5 minutes.
2. Using a #2 Phillips screwdriver, remove the 4 screws (2 indicated on one side) from the Console Assembly.



3. Carefully lift the Console Assembly and expose the Cable Connections.



4. Carefully disconnect the Cables noting their locations.  
**Note:** do not crimp any of the Console Cables.

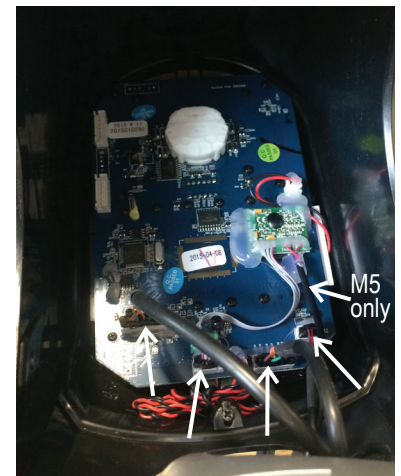



5. Using a #2 Phillips screwdriver, remove the indicated (by ovals) screws and only loosen the lowest indicated screw (arrow) from the Right Fan Cover.

**Note:** Loosen the lowest screw by at least 3 full rotations.



6. The Right Fan Cover has a tab that needs to be pushed upward to clear the loosened screw. While pushing up on the tab, remove the Right Fan Cover from the assembly.

**Note:** the AC Power Cable is attached to the inside of the Right Fan Cover. Be sure not to crimp the cable by placing the Right Fan Cover close to the front of the machine.

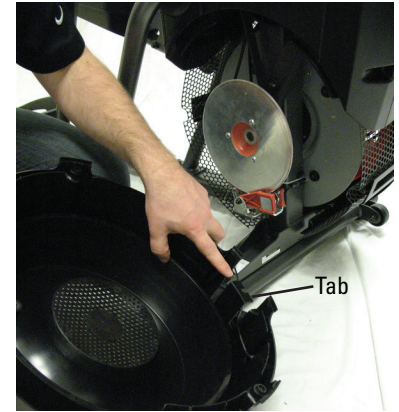

7. Remove the indicated Cap from both sides of the machine.

8. Using a 6mm hex wrench, remove the hardware exposed below the Cap from both sides of the machine.

9. Slide the Leg Assemblies off of the machine.



10. Using a #2 Phillips screwdriver, remove the indicated screw from the Rear Shroud.

11. Carefully remove the Rear Shroud from the machine. Place a standard screwdriver behind and near the middle of the Rear Shroud and gently pry until it releases. Then move the screwdriver to the bottom and gently pry until the Rear Shroud comes off.

12. Remove the Caps from the machine.

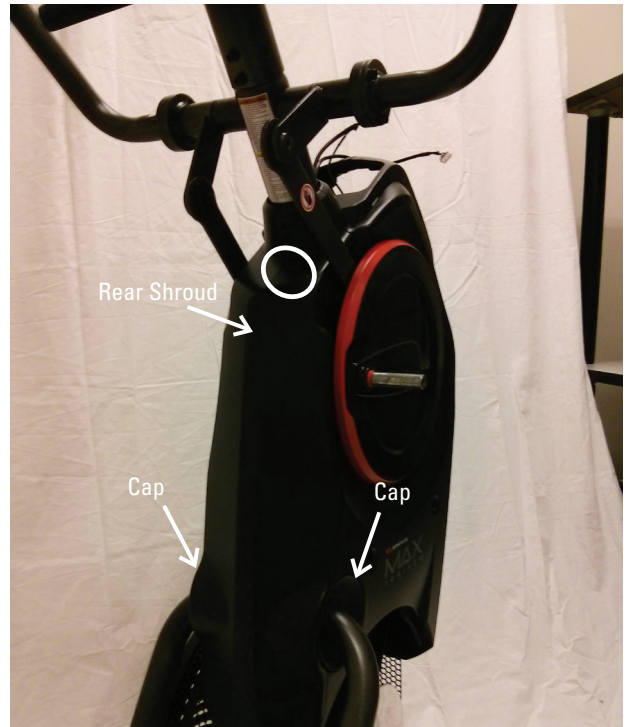

13. Using a #2 Phillips screwdriver, remove the indicated (by ovals) screws and only loosen the lowest indicated screw (arrow) from the Left Fan Cover.

14. The Left Fan Cover Assembly has a tab that needs to be pushed upward to clear the loosened screw. While pushing up on the tab, remove the Left Fan Cover Assembly.

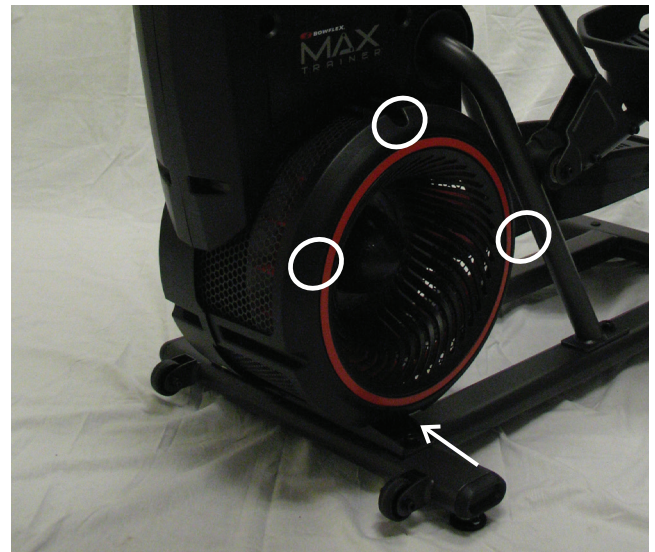

15. Remove the Left Fan Cover Assembly from the machine. Be sure to note how the fan screens are set into the Left Fan Cover to assist with the replacement procedure.



16. Using a #2 Phillips screwdriver, remove the 2 indicated screws from the Crank Cover. Repeat on the other side of the machine.

17. Remove the Crank Covers from the machine.

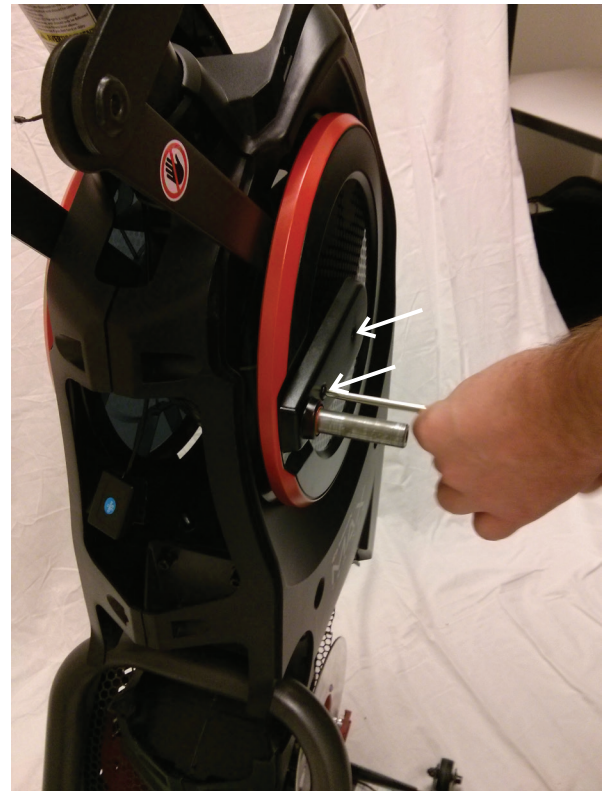

18. Using a #2 Phillips screwdriver, remove the screws from the Right and Left Shrouds. ( 3 screws on the Right Shroud, 9 on the Left Shroud) Remove the upper screws labeled ' \* ' last.

19. Place a rag or protective material below the Connector Arm to protect the Shrouds from potential scratches from the Connector Arms.

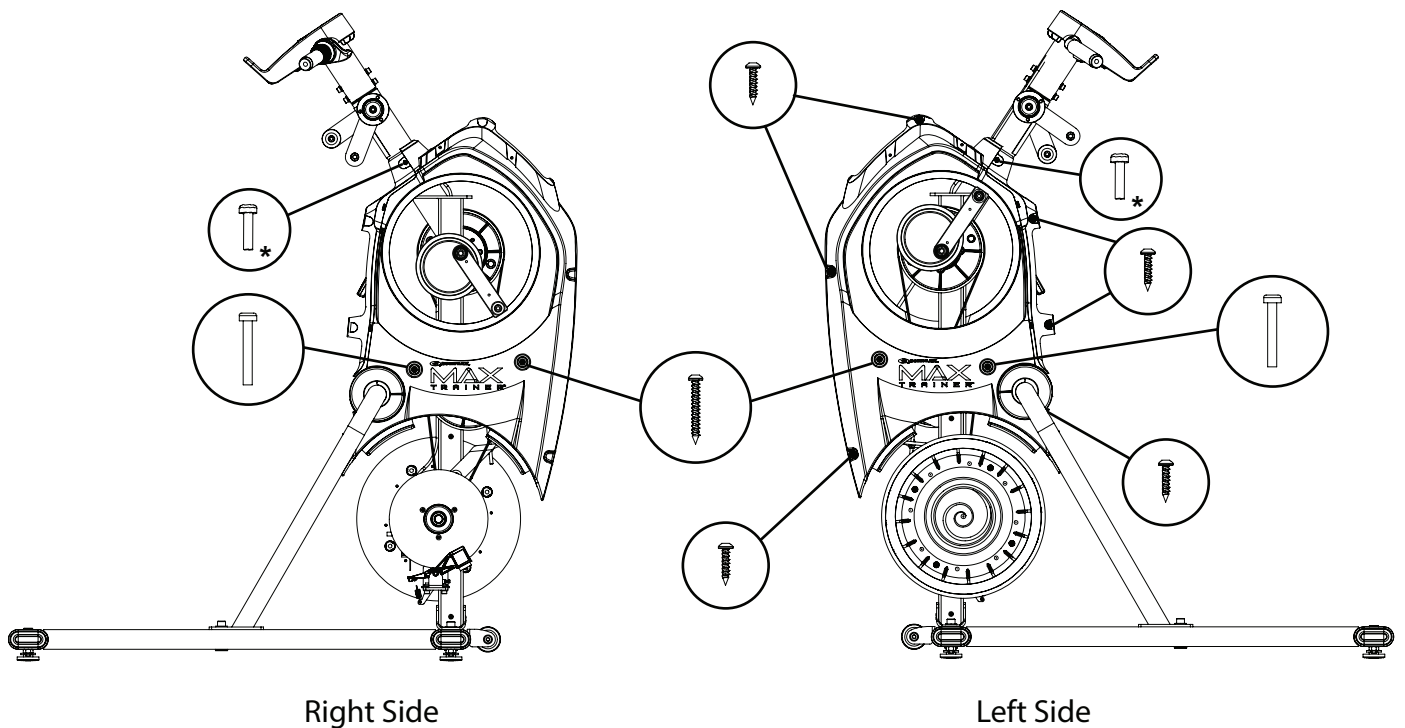

20. Using a 6mm hex wrench, remove the hardware that connects the Connector Arms and the Pivot Arms.

**Note:** Slowly lower the Connector Arm downward onto the rag or protective material protecting the Shrouds.

21. Carefully remove the Shrouds from the machine.

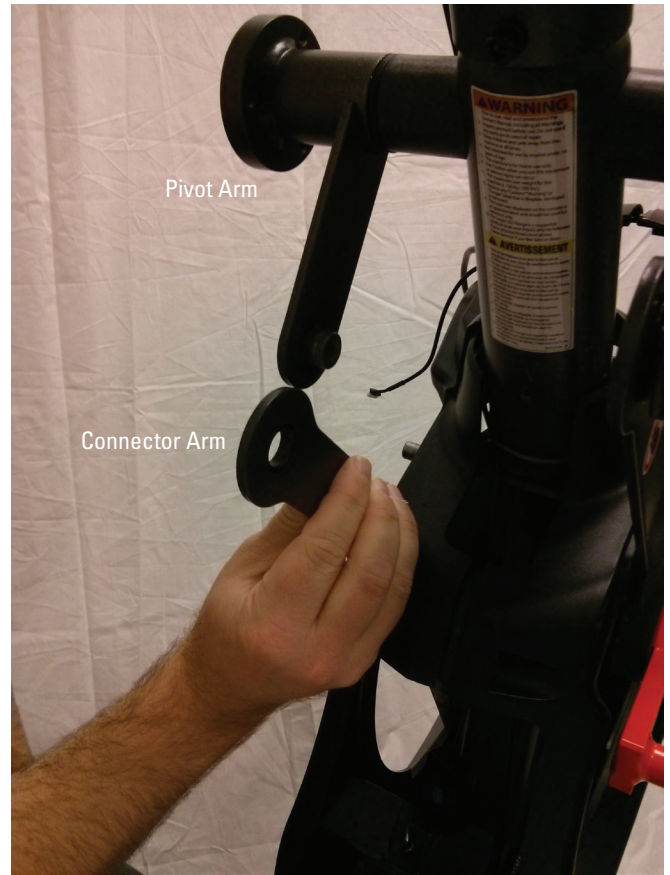

If replacing the Right Fan Cover:

A. Using a 15mm open face wrench, remove the Securing Ring from the outside of the Right Fan Cover.

B. Remove the AC Inlet from the inside of the Right Fan Cover.

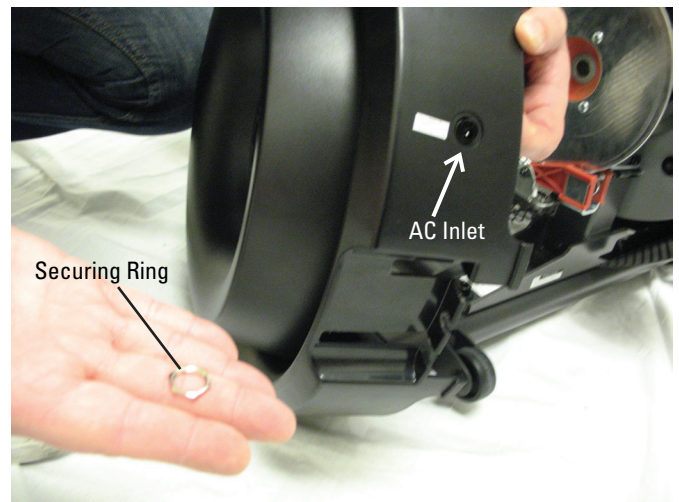

22. Installation is the reverse procedure.

**Note:** When replacing the Crank Arms, be sure the Right and Left Crank Arms are oriented inline and opposite each other.

The Crank Nuts should be tightened to a torque value of 29-32.5 ft lbs (or 350-390 in lbs).

23. Final Inspection

Inspect your machine to ensure that all hardware is tight and components are properly assembled.



**Do not use until the machine has been fully assembled and inspected for correct performance in accordance with the Owner's Manual.**

**NOTICE:** This document provides instructions for the replacement of the Speed Sensor on the Bowflex Max Trainer® M3 / M5.

**If you need assistance, please call Bowflex Customer Service at 1-800-605-3369.**

 **This icon means a potentially hazardous situation which, if not avoided, could result in death or serious injury. Read and understand all Warnings on this machine.**

Nautilus, Inc., (800) NAUTILUS / (800) 628-8458, www.NautilusInc.com - Customer Service: North America (800) 605-3369, csnls@nautilus.com | outside U.S. www.nautilusinternational.com | Printed in China | © 2014 Nautilus, Inc. | ® indicates trademarks registered in the United States. These marks may be registered in other nations or otherwise protected by common law. Bowflex, the B logo, and Bowflex Max Trainer are trademarks owned by or licensed to Nautilus, Inc.

### Important Safety Instructions - Before servicing or using this equipment, obey the following warnings:

 **This icon means a potentially hazardous situation which, if not avoided, could result in death or serious injury. Read and understand all Warnings on this machine.**

- Read and understand the Part Replacement Procedure before working on the machine. Failure to obey the instructions and safety warnings could cause injury to the service technician or bystanders.
- Keep bystanders and children away from the product being serviced at all times.
- Make sure that the repair is done in an appropriate work space away from foot traffic and exposure to bystanders.
- Disconnect all power and allow to sit for 5 minutes before you service this machine.
- Some components of the equipment can be heavy or awkward. Enlist the service of a second person when you do maintenance steps involving these components. Do not try to do heavy or awkward steps on your own.
- If replacement parts are necessary, use only genuine Nautilus replacement parts and hardware. Failure to use genuine replacement parts can cause a risk to users, keep the machine from operating correctly and will void the warranty.
- Be sure that all warning stickers and instructional placards applied to the product stay present and in good condition when doing maintenance or replacing components. If necessary request replacement warning stickers or placards from Nautilus customer service.
- Do not try to change the design or functionality of the machine being serviced as this can adversely effect user safety and will void the warranty.
- Do not use the machine until all shrouds, instructions, warning labels and correct functionality have been verified and tested for correct performance.

### Tools Required (not included)

#2 Phillips screwdriver

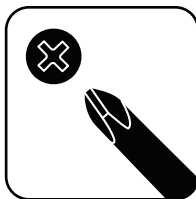

6mm hex wrench



**Note:** The Bowflex Max Trainer® M3 is used in the following images. The procedure is the same for the M5 model.

1. Unplug the AC Adapter from the machine and wait 5 minutes.

2. Using a #2 Phillips screwdriver, remove the indicated (by ovals) screws and only loosen the lowest indicated screw (arrow) from the Right Fan Cover.

**Note:** Loosen the lowest screw by at least 3 full rotations.

3. The Right Fan Cover has a tab that needs to be pushed upward to clear the loosened screw. While pushing up on the tab, remove the Right Fan Cover from the assembly.

**Note:** the AC Power Cable is attached to the inside of the Right Fan Cover. Be sure not to crimp the cable by placing the Right Fan Cover close to the front of the machine.

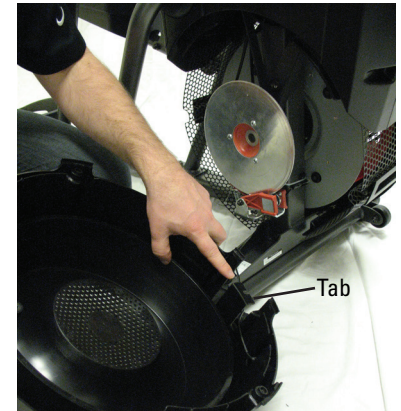
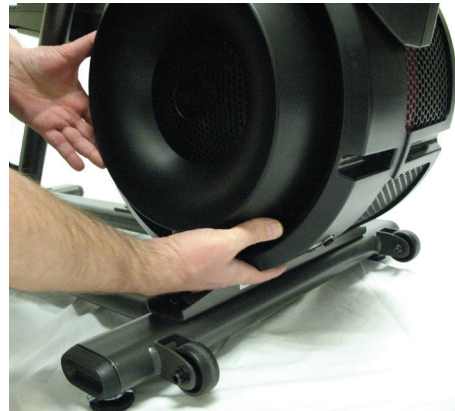

**Note:** Disc Brake is hidden for image clarity.

4. Using a #2 Phillips screwdriver, remove the screw that attaches the Speed Sensor.

**Note:** The distance of the new Speed Sensor Magnet must be the same distance from the Fan Disc for proper operation. Be sure to note the distance before removing the Speed Sensor Magnet.

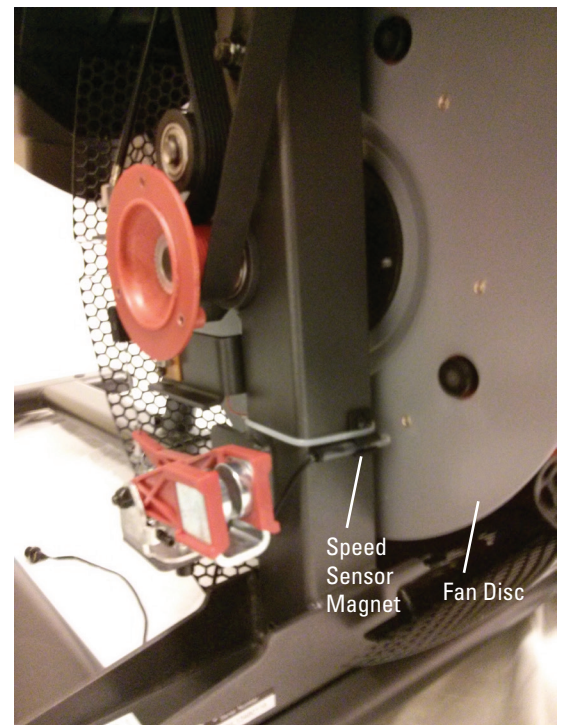

5. Disconnect the Speed Sensor Cable noting how it was routed for re-assembly.

**Note:** Do not crimp the Cables.

6. Using a #2 Phillips screwdriver, attach the new Speed Sensor. Be sure to place it the same distance from the Pulley as the old Speed Sensor Magnet.

7. Route the new Speed Sensor Cable under the bracket and connect the cable.

8. Installation is the reverse procedure.

9. Final Inspection

Inspect your machine to ensure that all hardware is tight and components are properly assembled.



**Do not use until the machine has been fully assembled and inspected for correct performance in accordance with the Owner's Manual.**

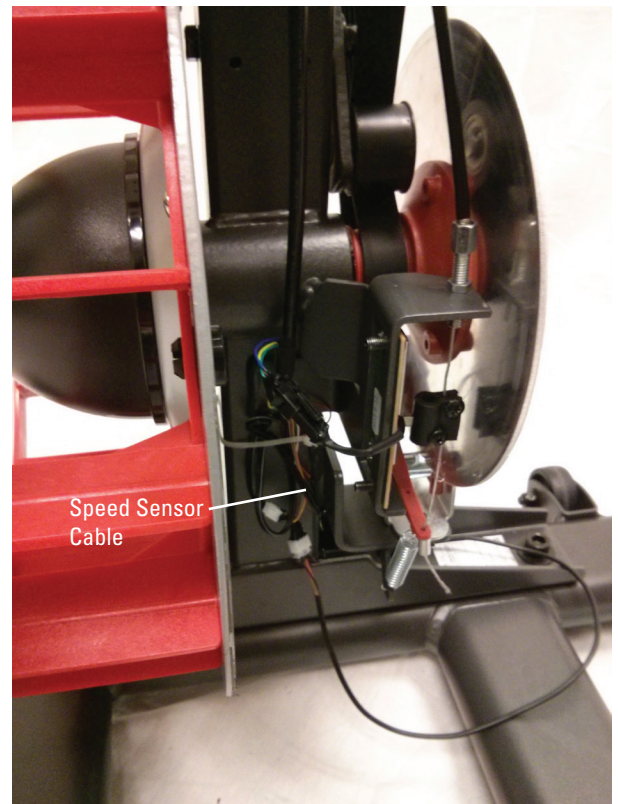

**NOTICE:** This document provides instructions for the replacement of the Tensioner on the Bowflex Max Trainer® M3 / M5.

**If you need assistance, please call Bowflex Customer Service at 1-800-605-3369.**

 **This icon means a potentially hazardous situation which, if not avoided, could result in death or serious injury. Read and understand all Warnings on this machine.**

Nautilus, Inc., (800) NAUTILUS / (800) 628-8458, www.NautilusInc.com - Customer Service: North America (800) 605-3369, csnls@nautilus.com | outside U.S. www.nautilusinternational.com | Printed in China | © 2017 Nautilus, Inc. | ® indicates trademarks registered in the United States. These marks may be registered in other nations or otherwise protected by common law. Bowflex, the B logo, and Bowflex Max Trainer are trademarks owned by or licensed to Nautilus, Inc.

### Important Safety Instructions - Before servicing or using this equipment, obey the following warnings:

 **This icon means a potentially hazardous situation which, if not avoided, could result in death or serious injury. Read and understand all Warnings on this machine.**

- Read and understand the Part Replacement Procedure before working on the machine. Failure to obey the instructions and safety warnings could cause injury to the service technician or bystanders.
- Keep bystanders and children away from the product being serviced at all times.
- Make sure that the repair is done in an appropriate work space away from foot traffic and exposure to bystanders.
- Disconnect all power to the machine before you service it.
- Some components of the equipment can be heavy or awkward. Enlist the service of a second person when you do maintenance steps involving these components. Do not try to do heavy or awkward steps on your own.
- If replacement parts are necessary, use only genuine Nautilus replacement parts and hardware. Failure to use genuine replacement parts can cause a risk to users, keep the machine from operating correctly and will void the warranty.
- Be sure that all warning stickers and instructional placards applied to the product stay present and in good condition when doing maintenance or replacing components. If necessary request replacement warning stickers or placards from Nautilus customer service.
- Do not try to change the design or functionality of the machine being serviced as this can adversely effect user safety and will void the warranty.
- Do not use the machine until all shrouds, instructions, warning labels and correct functionality have been verified and tested for correct performance.

### Tools Required (not included)

#2 Phillips screwdriver

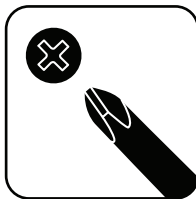

#2 Standard screwdriver



6mm hex wrench



10mm wrench





**Note:** The Bowflex Max Trainer® M3 is used in the following images. The procedure is the same for the M5 model.

1. Unplug the AC Adapter from the wall outlet and machine.
2. Using a #2 Phillips screwdriver, remove the 4 screws (2 indicated on one side) from the Console Assembly.



3. Carefully lift the Console Assembly and expose the Cable Connections.



4. Carefully disconnect the Cables noting their locations.

**Note:** Do not crimp any of the Console Cables.

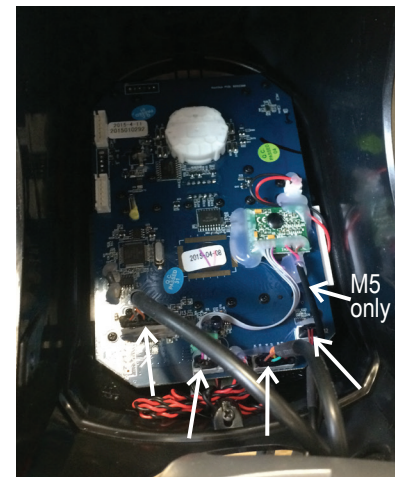

5. Using a 5mm hex wrench, remove the indicated hardware from the Upper Handlebars.

**Note:** Be aware that the Upper Handlebars must be supported when removing the hardware.



6. Using a #2 Phillips screwdriver, remove the indicated (by ovals) screws and only loosen the lowest indicated screw (arrow) from the Right Fan Cover.



7. The Right Fan Cover has a tab that needs to be pushed upward to clear the loosened screw. While pushing up on the tab, remove the Right Fan Cover from the assembly.

**Note:** the AC Power Cable is attached to the inside of the Right Fan Cover. Be sure not to crimp the cable by placing the Right Fan Cover close to the front of the machine.

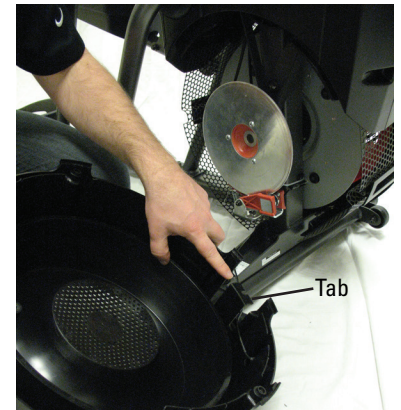
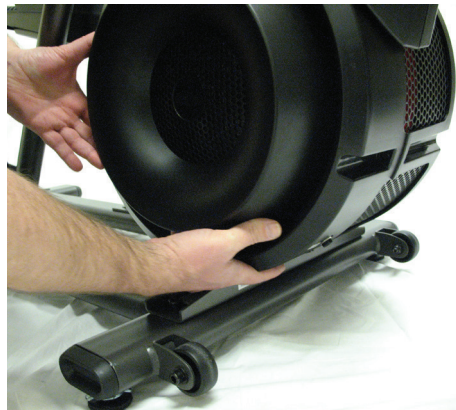

8. Remove the indicated Cap from both sides of the machine.

9. Using a 6mm hex wrench, remove the hardware exposed from below the Cap from both sides of the machine.

10. Slide the Leg Assemblies off of the machine.



11. Using a #2 Phillips screwdriver, remove the indicated screw from the Rear Shroud.

12. Carefully remove the Rear Shroud from the machine. Place a standard screwdriver behind and near the middle of the Rear Shroud and gently pry until it releases. Then move the screwdriver to the bottom and gently pry until the Rear Shroud comes off.

13. Remove the indicated Caps from the machine.

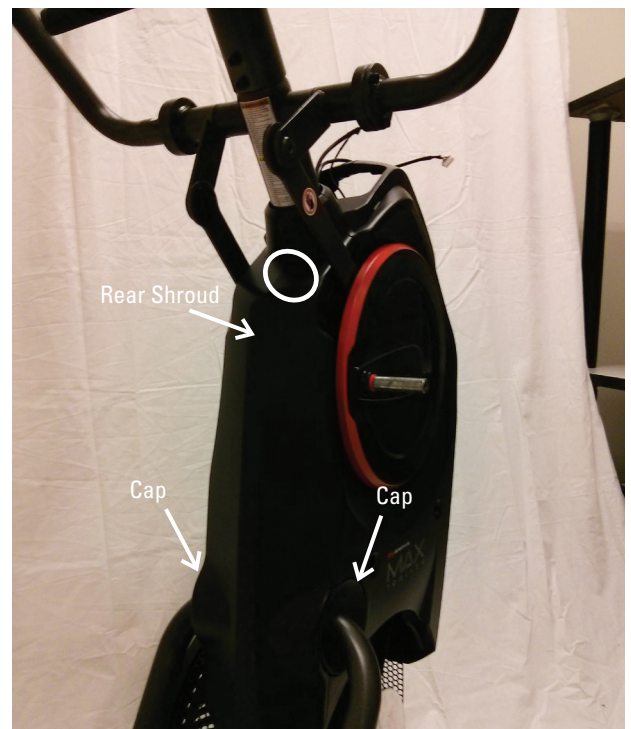

14. Using a #2 Phillips screwdriver, remove the indicated (by ovals) screws and only loosen the lowest indicated screw (arrow) from the Left Fan Cover.

15. The Left Fan Cover Assembly has a tab that needs to be pushed upward to clear the loosened screw. While pushing up on the tab, remove the Left Fan Cover Assembly.

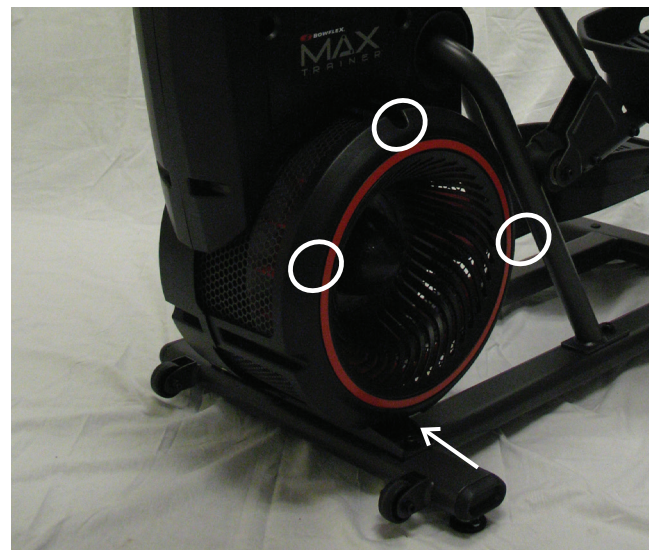

16. Remove the Left Fan Cover Assembly from the machine. Be sure to note how the fan screens are set into the Left Fan Cover to assist with the replacement procedure.

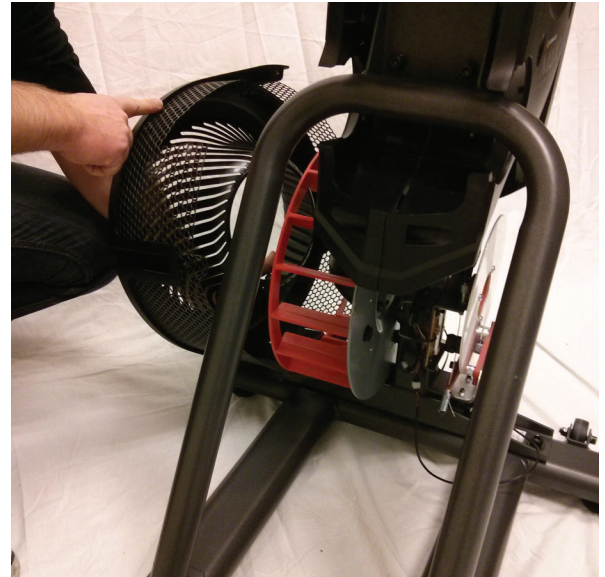

17. Using a #2 Phillips screwdriver, remove the 2 indicated screws from the Crank Cover. Repeat on the other side of the machine.

18. Remove the Crank Covers from the machine.



19. Place a rag or protective material below the Connector Arm to protect the Shrouds from potential scratches from the Connector Arms.

20. Using a 6mm hex wrench, remove the hardware that connects the Connector Arms and the Pivot Arms.

**Note:** The Connector Arm will pivot downward if not lowered slowly onto the rag protecting the Shrouds

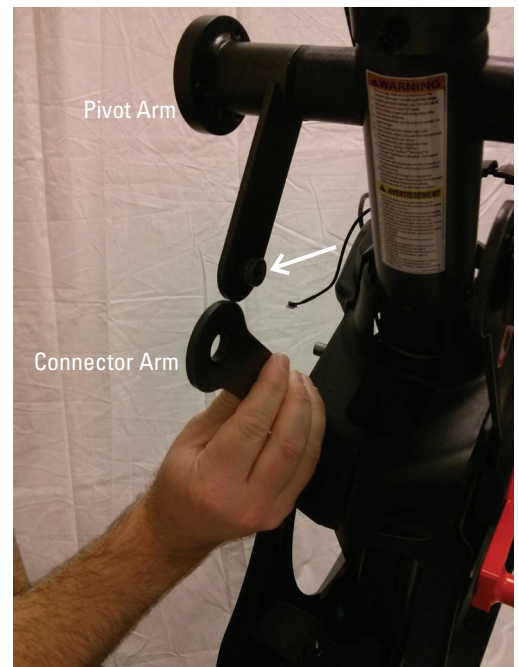

21. Using a #2 Phillips screwdriver, remove the screws from the Left Shroud. ( 9 screws on the Left Shroud) Remove the upper screws labeled ' \* ' last.

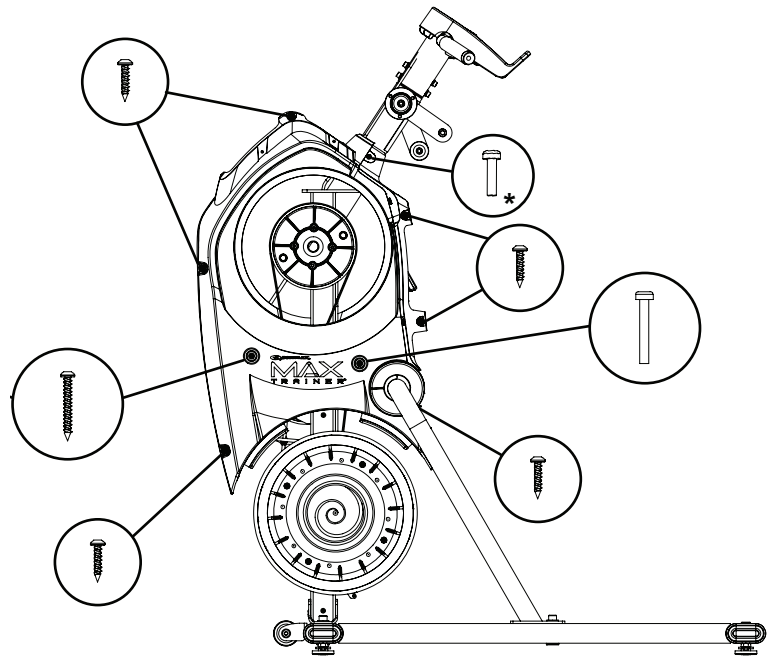

Left Side

**Note:** Shrouds are removed for clarity.

22. Observe the location of the “A” screw in the opening of the Tensioner. This will help with re-assembly.

23. Using a 4mm hex wrench, remove the screw indicated by “A” from the Tensioner.

24. Using a 8mm hex wrench, remove the screw indicated by “B” from the Tensioner.

**⚠ Keep fingers out of any pinch opportunities caused by the Drive Belt.**

25. Replace the old Tensioner with the new one by installing the “B” screw.

26. Adjust the new Tensioner so that the “A” screw can be tightened to be in the same location from Step 22. This will correctly tension the Drive Belt.

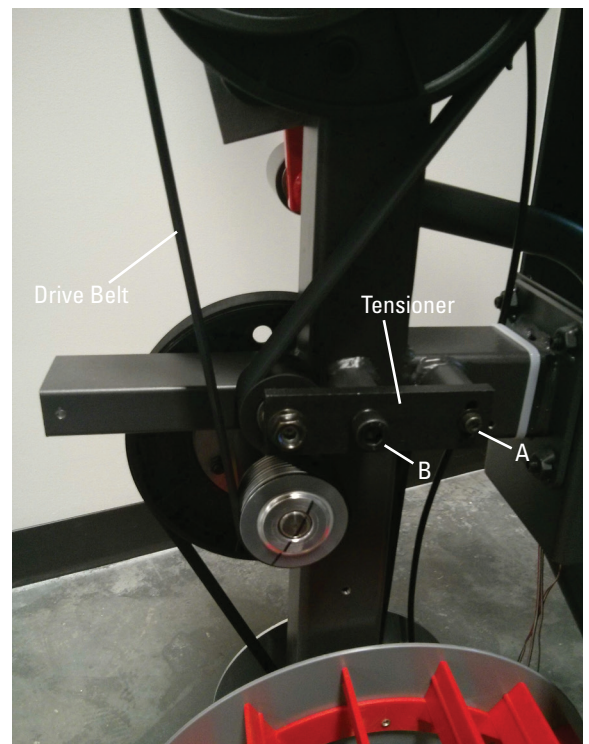

27. Re-assemble the machine in the reverse order of when the parts were removed.

28. Final Inspection  
Inspect your machine to ensure that all hardware is tight and components are properly assembled.

**⚠ Do not use until the machine has been fully assembled and inspected for correct performance in accordance with the Owner's Manual.**

**NOTICE:** This document provides instructions for the replacement of the Wireless Heart Rate Sensor on the Bowflex Max Trainer® M3 / M5.

**If you need assistance, please call Bowflex Customer Service at 1-800-605-3369.**

 **This icon means a potentially hazardous situation which, if not avoided, could result in death or serious injury. Read and understand all Warnings on this machine.**

Nautilus, Inc., (800) NAUTILUS / (800) 628-8458, www.NautilusInc.com - Customer Service: North America (800) 605-3369, csnls@nautilus.com | outside U.S. www.nautilusinternational.com | Printed in China | © 2014 Nautilus, Inc. | ® indicates trademarks registered in the United States. These marks may be registered in other nations or otherwise protected by common law. Bowflex, the B logo, and Bowflex Max Trainer are trademarks owned by or licensed to Nautilus, Inc.

### Important Safety Instructions - Before servicing or using this equipment, obey the following warnings:

 **This icon means a potentially hazardous situation which, if not avoided, could result in death or serious injury. Read and understand all Warnings on this machine.**

- Read and understand the Part Replacement Procedure before working on the machine. Failure to obey the instructions and safety warnings could cause injury to the service technician or bystanders.
- Keep bystanders and children away from the product being serviced at all times.
- Make sure that the repair is done in an appropriate work space away from foot traffic and exposure to bystanders.
- Disconnect all power and allow to sit for 5 minutes before you service this machine.
- Some components of the equipment can be heavy or awkward. Enlist the service of a second person when you do maintenance steps involving these components. Do not try to do heavy or awkward steps on your own.
- If replacement parts are necessary, use only genuine Nautilus replacement parts and hardware. Failure to use genuine replacement parts can cause a risk to users, keep the machine from operating correctly and will void the warranty.
- Be sure that all warning stickers and instructional placards applied to the product stay present and in good condition when doing maintenance or replacing components. If necessary request replacement warning stickers or placards from Nautilus customer service.
- Do not try to change the design or functionality of the machine being serviced as this can adversely effect user safety and will void the warranty.
- Do not use the machine until all shrouds, instructions, warning labels and correct functionality have been verified and tested for correct performance.

### Tools Required (not included)

#2 Phillips screwdriver

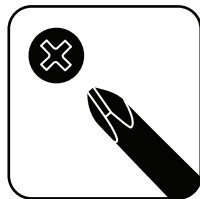

5 mm hex wrench



Standard screwdriver

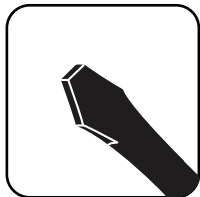

Piece of wire or string (around 3-4' in length)



**Note:** The Bowflex Max Trainer® M3 is used in the following images. The procedure is the same for the M5 model.

1. Unplug the AC Adapter from the machine and wait 5 minutes.
2. Using a #2 Phillips screwdriver, remove the indicated screw from the Rear Shroud.
3. Carefully remove the Rear Shroud from the machine. Place a standard screwdriver behind and near the middle of the Rear Shroud and gently pry until it releases. Then move the screwdriver to the bottom and gently pry until the Rear Shroud comes off.
4. Remove the Caps from the machine.



View of the exposed opening (behind Rear Shroud) showing the location of the Wireless Heart Rate Sensor and Cable:

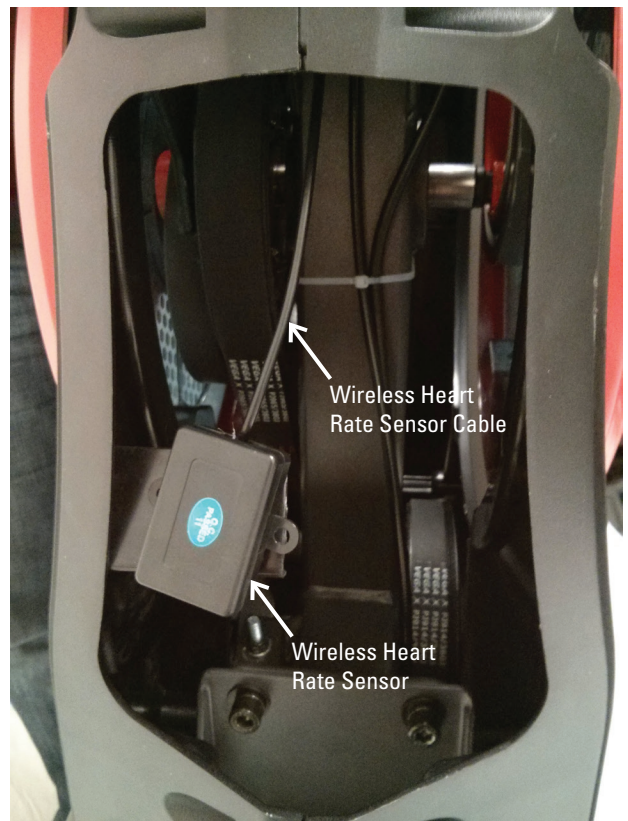

5. Using a #2 Phillips screwdriver, remove the 4 screws (2 indicated on one side) from the Console Assembly.



6. Carefully lift the Console Assembly and expose the Cable Connections.



7. Carefully disconnect the Cables noting their locations (see arrows).  
**Note:** do not crimp any of the Console Cables

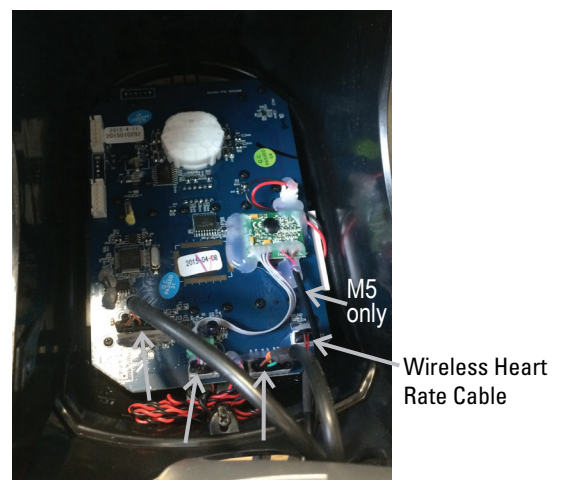

8. Place the Console Assembly in a safe and secure location.



9. Attach a piece of wire or string to the upper Heart Rate Cable of the Wireless Heart Rate Sensor (where it attached to the Console).

10. Gently remove the Wireless Heart Rate Sensor and Cable, routing the newly attached wire or string down to the Rear Shroud opening.

**Note:** If the Wireless Heart Rate Sensor was attached by an adhesive, be sure to remove any residue to be able to attach the new Sensor correctly.

11. Remove the old Wireless Heart Rate Sensor and Cable, leaving the piece of wire or string routed through the machine.

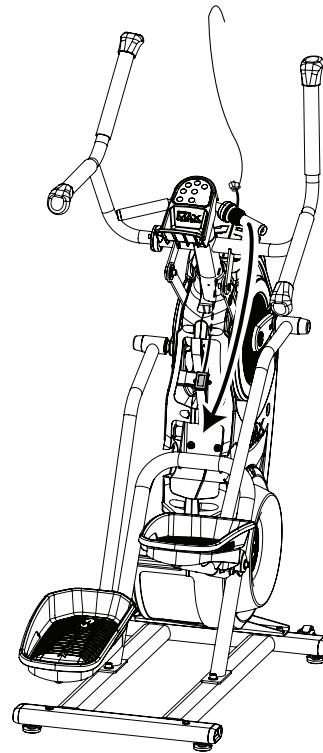

12. Attach the Connector end of the new Wireless Heart Rate Sensor to the wire or string, and gently route the Wireless Heart Rate Sensor cable up to the Console.

**Note:** do not crimp the Cable.

13. Remove the routing wire or string from the Wireless Heart Rate Cable.

14. Installation is the reverse procedure.

15. Final Inspection

Inspect your machine to ensure that all hardware is tight and components are properly assembled.

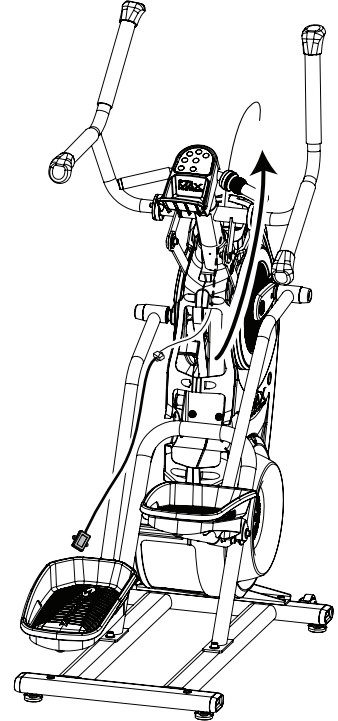

**Do not use until the machine has been fully assembled and inspected for correct performance in accordance with the Owner's Manual.**