

Table of Contents

Section Code	Section	Page Number
1	Important Safety Instructions	2
1	Safety Warning Labels and Serial Number	3
1	FCC Compliance	3
1	Specifications	4
1	Maintenance	5
1	Moving/Storing the Machine	6
1	Leveling the Machine	6
1	Heart Rate Armband	7
1	Adjustments	8
1	Locking the Flywheel for Storage	9
1	Troubleshooting	10
1	Maintenance Parts Exploded View	12
1	Replacement Procedure Skill Level	13
	Mechanical Procedures	
2	Adjust the Belt Tension	14
3	Calibrate the Magnetic Resistance Sensor	18
4	Install the Handlebar Bushing Kit	21
	Part Replacement	
5	Replace the Emergency Brake Pad	25
6	Replace the Brake / Resistance Knob Assembly	28
7	Replace the Crank Arm	32
8	Replace the Drive Belt	36
9	Replace the Drive Belt Cover	43
10	Replace the Drive Pulley	46
11	Replace the Fender	51
12	Replace the Flywheel Assembly	53
13	Replace the Flywheel Tensioners	61
14	Replace the Handlebar and Seat Post Bushing	65
15	Replace the Pedals	71
16	Replace the Power Inlet	74
17	Replace the Resistance Sensor and Sensor Magnet	79
18	Replace the Speed Sensor	83
19	Replace the Wiring Harness	91

NOTICE: This document provides important safety instructions, adjustments, and general troubleshooting information for the maintenance of the Schwinn™ IC4 / IC8 / 800IC and Bowflex™ C6 bikes.

If you need assistance, please call Nautilus Customer Service (if purchased in US/Canada) or your local distributor (if purchased outside US/Canada). To find your local distributor, go to: www.nautilusinternational.com

 **This icon means a potentially hazardous situation which, if not avoided, could result in death or serious injury. Read and understand all Warnings on this machine.**

Nautilus, Inc., www.NautilusInc.com, 5415 Centerpoint Parkway, Groveport, OH 43125 U.S.A. - Customer Service: North America (800) 605-3369, csnls@nautilus.com | outside U.S. www.nautilusinternational.com | Printed in China | © 2019 Nautilus, Inc. | Nautilus, the Nautilus logo, Bowflex and Schwinn are trademarks owned by or licensed to Nautilus, Inc., which are registered or otherwise protected by common law in the United States and other countries. | The Bluetooth® word mark and logos are registered trademarks owned by Bluetooth SIG, Inc., and any use of such marks by Nautilus, Inc. is under license. | ORIGINAL DOCUMENT - ENGLISH VERSION ONLY

Important Safety Instructions

 **This icon means a potentially hazardous situation which, if not avoided, could result in death or serious injury. Read and understand all Warnings on this machine.**

Before servicing or using this equipment, obey the following warnings:

 **Read and understand the Service Manual before working on the machine. Failure to obey the instructions and safety warnings could cause injury to the service technician or bystanders.**

- Keep bystanders and children away from the product being serviced at all times.
- Make sure that the repair is done in an appropriate work space away from foot traffic and exposure to bystanders.
- Disconnect all power to the machine before you service it.
- Some components of the equipment can be heavy or awkward. Enlist the service of a second person when you do maintenance steps involving these components. Do not try to do heavy or awkward steps on your own.
- Use only replacement parts and hardware that are supplied or approved by Nautilus. Failure to use Nautilus-approved replacement parts can adversely affect the safety and functionality of the equipment creating a risk to users and will void the warranty.
- Be sure that all warning stickers and instructional placards applied to the product stay present and in good condition when doing maintenance or replacing components. If at any time the Warning labels become loose, unreadable or dislodged, replace the labels. If purchased in US/Canada, contact Customer Service for replacement labels. If purchased outside US/Canada, contact your local distributor for them.
- Do not try to change the design or functionality of the machine being serviced as this can adversely affect user safety.
- Do not put the machine back in service until all shrouds, instructions, warning labels and correct functionality have been verified and tested for correct performance.

• **SAVE THESE INSTRUCTIONS**

SAFETY WARNING LABELS AND SERIAL NUMBER



WARNING!

- Injury or death is possible if caution is not used while using this machine.
- Keep children and pets away.
- Read and follow all warnings on this machine.
- Refer to the Owner's Manual for additional warnings and safety information.
- The heart rate displayed is an approximation and should be used for reference only.
- Not intended for use by anyone under 14 years of age.
- The maximum user weight for this machine is 330 lbs (150 kg.).
- This machine is for home use only.
- Consult a physician prior to using any exercise equipment.
- Set up and operate the stationary exercise bicycle on a solid level surface.
- Care should be taken in mounting and dismounting the stationary exercise equipment. Before dismounting, bring the machine to a complete stop.
- Spinning pedals can cause injury.
- This exercise bicycle does not have a freewheel and pedal speed must be reduced in a controlled manner.

(Label is only available on the IC4 in English and French Canadian.)

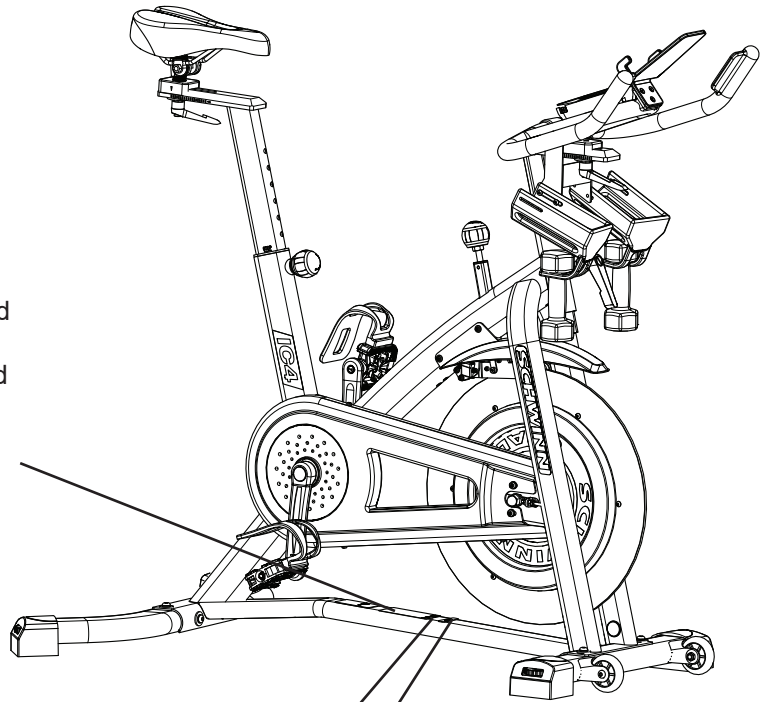

Product specification

Serial number

FCC Compliance

⚠ Changes or modifications to this unit not expressly approved by the party responsible for compliance could void the user's authority to operate the equipment.

This product complies with part 15 of the FCC rules. Operation is subject to the following two conditions: (1) This device may not cause harmful interference, and (2) this device must accept any interference received, including interference that may cause undesired operation.

Note: This product has been tested and found to comply with the limits for a Class B digital device, pursuant to CFR47 Part 15 Subpart B of the FCC Rules. These limits are designed to provide reasonable protection against harmful interference in a residential installation. This equipment generates radio frequency energy and, if not installed and used in accordance with the instructions, may cause harmful interference to radio communications.

However, there is no guarantee that interference will not occur in a particular installation. In the unlikely event that this equipment does cause harmful interference to radio or television reception, which can be determined by turning the equipment off and on, the user is encouraged to try to correct the interference by one or more of the following measures:

- Reorient or relocate the receiving antenna.
- Increase the separation between the equipment and receiver.
- Consult the dealer or an experienced radio/TV technician for help.

This product complies with the European Radio Equipment Directive 2014/53/EU

SPECIFICATIONS

Maximum User Weight: 150 kg (330 lbs.)
Machine Weight without Dumbbells: 48.1 kg (106 lbs.)
Weight of Dumbbells (supplied with IC4): 2.7 kg (6 lbs.)
Total Surface Area (footprint) of equipment: 6667 cm² (1033.3 in²)

Power Requirements

(Power Adapter):

Input Voltage: 100-240V AC, 50-60Hz, 0.5A
 Output Voltage: 9V DC, 1.5A

(Arm Band

- supplied with IC4 and C6): Rechargeable lithium battery

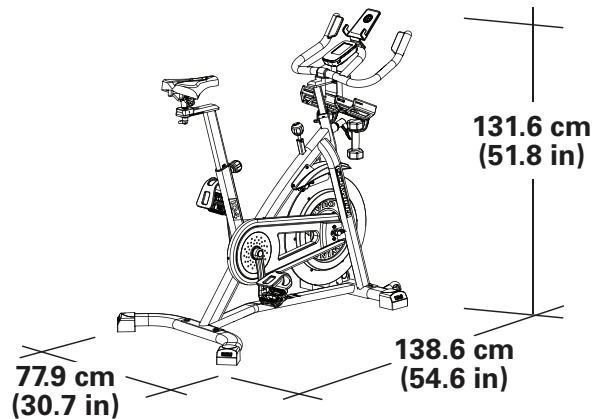

DO NOT dispose of this product as refuse. This product is to be recycled. For proper disposal of this product, please follow the prescribed methods at an approved waste center.

Select the area where you are going to set up and operate your machine. For safe operation, the location must be on a hard, level surface. Keep the workout area clear 0.6m (24") along the side used to access the machine and to the rear of the machine. Allow a workout area of a minimum 1.39 m x 2.00 m (54.7 in x 78.7 in).

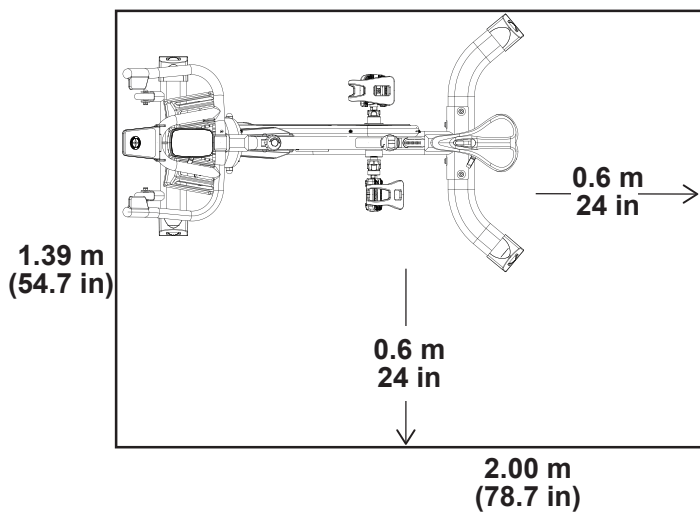

MAINTENANCE

Read all maintenance instructions fully before you start any repair work. In some conditions, an assistant is required to do the necessary tasks.

⚠ Equipment must be regularly examined for damage and repairs. The owner is responsible to make sure that regular maintenance is done. Worn or damaged components must be repaired or replaced immediately. Only manufacturer supplied components can be used to maintain and repair the equipment.

If at any time the Warning labels become loose, unreadable or dislodged, replace the labels. If purchased in US/Canada, contact Customer Service for replacement labels. If purchased outside US/Canada, contact your local distributor for them.

Disconnect all power to the machine before you service it.

Daily: Before each use, examine the exercise machine for loose, broken, damaged, or worn parts. Do not use if found in this condition. Repair or replace all parts at the first sign of wear or damage. Make sure adjustment knobs are tight. Tighten as necessary. After each workout, use a damp cloth to wipe your machine and Console free of moisture.

NOTICE: If necessary, only use a mild dish soap with a soft cloth to clean the Console. Do not clean with a petroleum based solvent, automotive cleaner, or any product that contains ammonia. Do not clean the Console in direct sunlight or at high temperatures. Be sure to keep the Console free of moisture.

Weekly: Check pedals and tighten as necessary.

⚠ Since this machine operates with a fixed gear, do not back, or reverse, pedal. Doing so may loosen the Pedals, which could result in damage to the machine and/or injury to the user. Never operate this machine with loose Pedals.

Clean the machine to remove any dust, dirt, or grime from the surfaces. Check for smooth seat operation. If needed, sparingly apply a thin coating of silicone lube to ease operation.

⚠ Silicone lubricant is not intended for human consumption. Keep out of reach of children. Store in a safe place.

Note: Do not use petroleum based products.

Monthly or after 20 hours: Check crank arms and tighten as necessary. Make sure all bolts and screws are tight. Tighten as necessary.

Check the drive belt tension and adjust if necessary.

Checking the Drive Belt Tension

To check the Drive Belt tension, the bike needs to be operated. Get the pedals rotating at about 20 RPM. Then suddenly increase the RPM to your maximum ability. If the pedals move normally with no slipping, the tension is correct. If the Pedals slip, the belt needs to be adjusted.

Adjusting the Drive Belt Tension

1. To change the tension of the Drive Belt, loosen the Axle Nuts. Use a 15mm open end wrench to hold the Axle Nut on one side steady, and loosen the Axle Nut on the opposite side with a 15mm socket and wrench.
2. If the Drive Belt is too loose and slipping, use a 10mm wrench to turn each Flywheel Retainer Nut a 1/4 turn to the right (clockwise).
3. Re-test the tension of the Drive Belt, and adjust if still necessary.

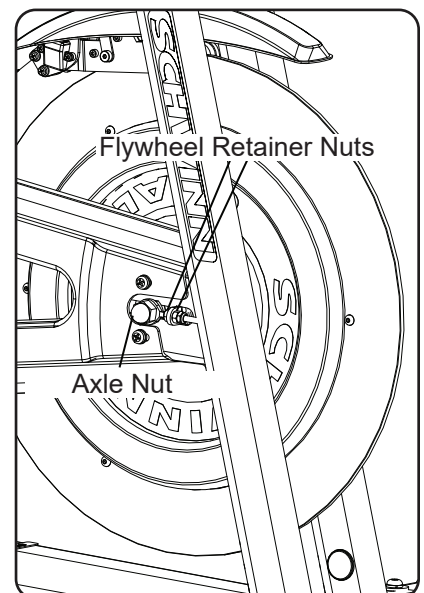

A detailed "Adjust the Belt Tension" procedure can be found in the Service Manual.

ADJUSTMENTS / OPERATIONS

Moving and Storing the Machine

⚠ The machine may be moved by one or more persons depending on their physical abilities and capacities. Make sure that you and others are all physically fit and able to move the machine safely.

1. Remove the dumbbells, any media devices, or water bottles from the bike before moving it.
2. To lock the Flywheel, turn the Emergency Brake/Resistance Adjustment Knob clockwise until it encounters an increase in resistance. Then rotate the Emergency Brake/Resistance Adjustment Knob another 1/2 turn clockwise.

⚠ Tighten the Emergency Brake/Resistance Adjustment Knob as described until the Flywheel is locked before moving it.

3. To move the bike, carefully pull the Handlebars toward you while pushing the front of the bike downward. Push the bike to the desired location.

NOTICE: Be careful when you move the machine. Abrupt motions can affect the computer operation.

⚠ For safe storage of the machine, remove the power supply and place in a secure location. Tighten the Brake/Resistance Adjustment Knob as described until the Flywheel is locked. Place the machine in a secure location away from children and pets.

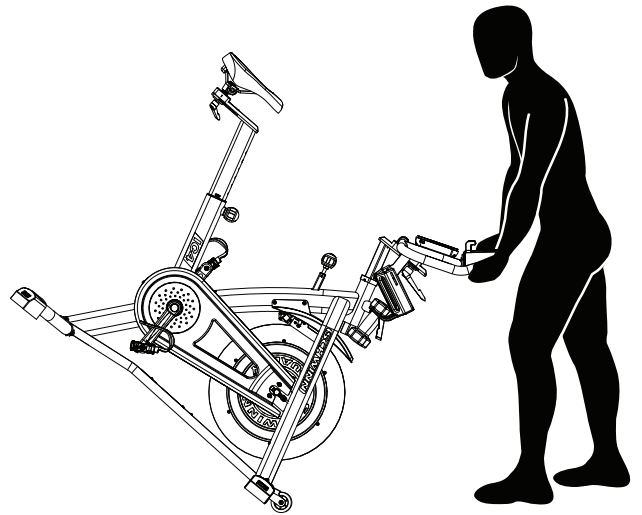

Leveling the Machine

The machine needs to be leveled if your workout area is uneven. Levelers are found on each side of the stabilizers. Lift the stabilizer slightly to take the weight off the adjuster, then turn the knob to adjust the stabilizer foot.

⚠ Do not adjust the levelers to such a height that they detach or unscrew from the machine. Injury to you or damage to the machine can occur.

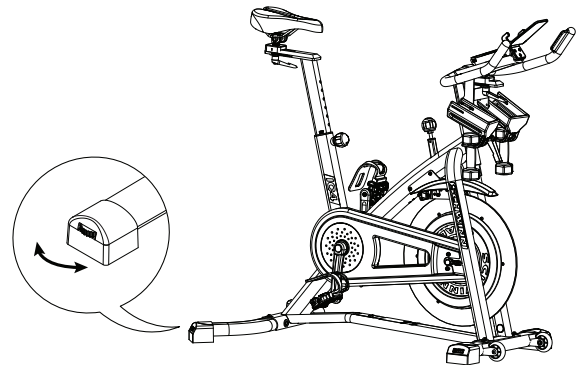

Make sure the machine is level and stable before you exercise.

Emergency Stop

To stop the pedals immediately, push down hard on the Emergency Brake/Resistance Adjustment Knob.

⚠ This bike cannot stop the Pedals independently of the Flywheel. Reduce the pace to slow the Flywheel and Pedals to a stop. Do not dismount the bike until the Pedals have come to a complete stop. Be aware that the moving Pedals can strike the backs of the legs.

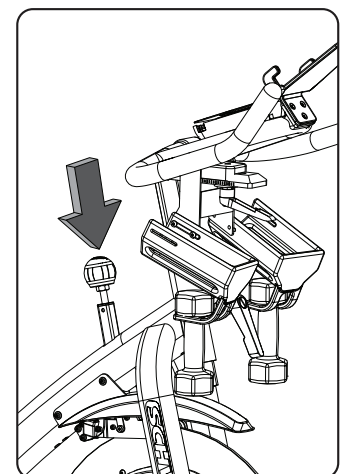

Workout with Other Fitness Apps

This fitness machine has integrated Bluetooth® connectivity which allows it to work with a number of fitness apps. For our latest list of supported apps, please visit: www.nautilus.com/partners

Bluetooth® Heart Rate Enabled

Your fitness machine is equipped to be able to receive a signal from a Bluetooth® Heart Rate Sensing device. When connected, the Console will display the Bluetooth® Connected icon. Be sure to follow the described method to sync your device.

⚠️ If you have a pacemaker or other implanted electronic device, consult your doctor before using a Bluetooth® strap or other Bluetooth® heart rate monitor.

Bluetooth® Heart Rate Armband (supplied with the IC4 and C6 machines only)

Your fitness machine is provided with a Bluetooth® Heart Rate Armband. When the Bluetooth® Heart Rate Armband is connected, the Console will display the Bluetooth® Connected icon.

⚠️ If you have a pacemaker or other implanted electronic device, consult your doctor before using a Bluetooth® armband or other Bluetooth® heart rate monitor.

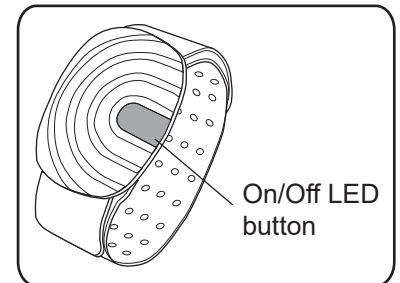

The Heart Rate Armband should be worn on the upper portion of your forearm, with the Heart Rate Sensor to the inside of your forearm. It should be snug enough not to move around on your arm, but not so tight that it restricts blood circulation.

Note: Be sure to remove the protective cover from the Heart Rate Sensor before use.

1. Put the Bluetooth® Heart Rate Armband onto the upper portion of your forearm.
2. Push the On/Off LED button on the Heart Rate Armband to activate it. The LED will flash blue quickly, indicating that the armband has been activated.
3. The LED will flash blue slowly when a heart rate is detected. The Bluetooth® Connected icon will activate on the Console when connected. You are ready to workout.

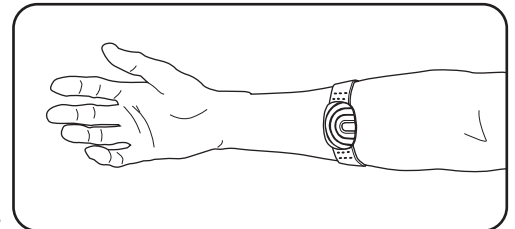

At the end of your workout, push the On/Off LED button to disconnect and deactivate your Heart Rate Armband.

If you press the On/Off LED button and the LED flashes red several times, the battery is low and should be charged. To charge the Bluetooth® Heart Rate Armband, connect the Charging Cable to the Charging Terminals on the inside of the Sensor. Connect the Charging Cable to a powered USB Port. The LED will flash red and green while charging. When fully charged, the LED will be green continuously.

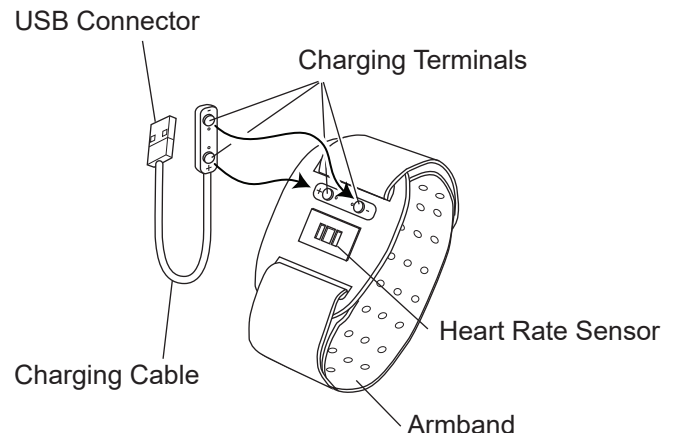

Seat Adjustment

Correct seat placement encourages exercise efficiency and comfort, while reducing the risk of injury.

1. With a Pedal in the forward position, place the heel of your foot to the lowest part of it. Your leg should be bent slightly at the knee.
2. If your leg is too straight or your foot cannot touch the Pedal, you need to move the seat downward. If your leg is bent too much, you need to move the seat upward.

! Step off the machine before you adjust the seat.

3. Loosen and pull the Seat Post Adjustment Knob on the Seat Post. Adjust the seat to the desired height.

! Do not lift the Seat post above the “STOP” mark on the Seat Post.

4. Release the Seat Post Adjustment Knob to engage the locking pin. Be sure that the pin is fully engaged and fully tighten the adjustment knob.
5. To move the seat closer to, or away from the console, loosen the seat adjustment knob. Slide the seat to the desired position and fully tighten the knob.

Note: If the handle cannot turn due to collision with another part, pull the handle, turn and push it back in to reposition it. Continue turning as needed.

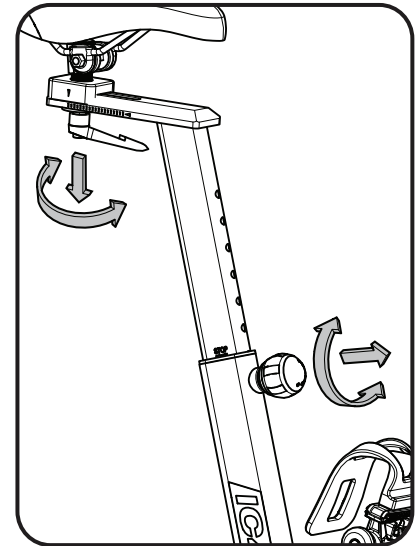

Foot Position / Pedal Strap Adjustment

Foot pedals with straps provide secure footing to the exercise bike.

1. Put the ball of each foot in the Foot Restraint on the Pedals.
2. Fasten the strap over the shoe.
3. Repeat for the other foot.

Be sure toes and knees point directly forward to ensure maximum Pedal efficiency. Pedal straps can be left in position for subsequent workouts.

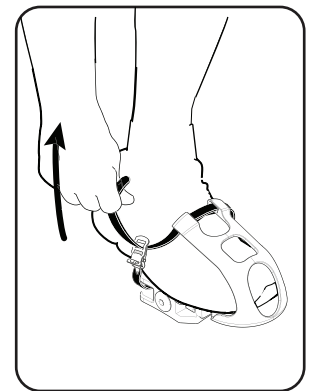

Using the Shoe Clips (Cleats)

Foot pedals that are equipped for cycling shoes with cleats provide secure footing on the exercise bike. The shoe cleats provided fit both the right and left Pedals.

! Prior to use, make sure you understand the operation of the engagement / release mechanism for the pedals and cleats (shoes).

Keep cleats and bindings clear of dirt and debris to ensure engagement and release.

Check the cleats periodically for wear. When the cleats are worn, replace them. Replace the cleat when it becomes difficult to release, or starts to release with much less effort than when it was in new condition.

Pedals and cleats are SPD Compatible. They fit any shoe size with the correct cleat mounts: shoes with “Standard 2-Hole MTB SPD Cleat Mounts” (MTB SPD = Mountain Bike Shimano Pedaling Dynamics).

1. Be sure that the arrow on top of the Pedal points forward.
2. Push the cleat down and forward to engage the Pedal.
3. Repeat for the other foot.

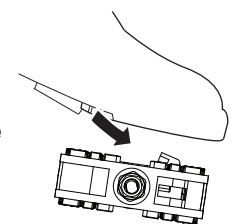

Engage

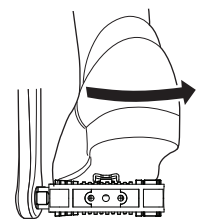

Disengage (release)

4. Practice engaging and disengaging from the Pedals before starting your workout.

To disengage (release) the cleats from the pedals, push the heels outward and lift.

If the body weight of a user is very low, the user may have difficulty with operation of the engagement/release mechanism in the Pedals. It may be necessary to decrease the retention force of the mechanism. To adjust the retention:

1. Locate the opening in the rear of the Pedal for access to the adjustment bolt. It is between the 2 screws that attach the Foot Restraint to the Pedal.
2. Use a 3mm hex wrench to turn the adjustment bolt. To decrease the retention, turn it left (counterclockwise). To increase the retention, turn it right (clockwise).

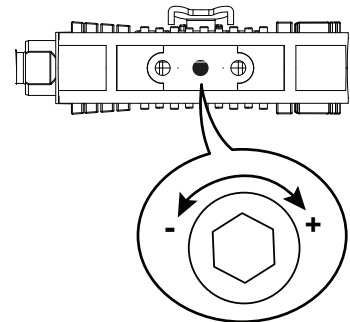

Handlebar Adjustment

To adjust the handlebar position:

1. Loosen the Handlebar Post Adjustment Knob on the Handlebar Post. Adjust the Handlebar to the desired height.

! Do not lift the Handlebar Post above the “STOP” mark on the Handlebar Post.

2. Tighten the Handlebar Post Adjustment Knob to engage the locking pin. Be sure that the pin is fully engaged and fully tighten the adjustment knob.

NOTICE: Do not crimp the cables.

3. To move the Handlebar closer to, or away from the console, loosen the Handlebar Adjustment Knob. Slide the Handlebar to the desired position and fully tighten the knob.

Note: If the handle cannot turn due to collision with another part, pull the handle, turn and push it back in to reposition it. Continue turning as needed.

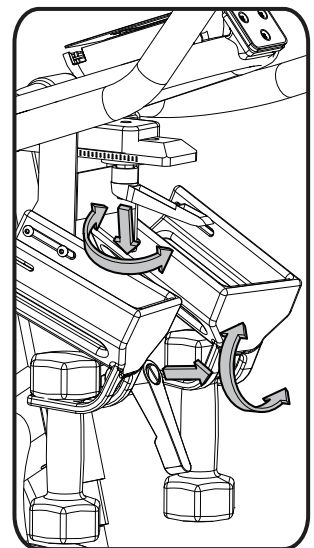

Locking the Flywheel for Storage

When the machine is not in use, be sure to lock the Flywheel with the Emergency Brake/Resistance Adjustment Knob. To lock the Flywheel, turn the Emergency Brake/Resistance Adjustment Knob clockwise until it encounters an increase in resistance. Then rotate the Emergency Brake/Resistance Adjustment Knob another 1/2 turn clockwise. The Flywheel is now locked. The flywheel should be locked for storage of the machine.

! For safe storage of the machine, remove the power supply and place in a secure location. Tighten the Brake/Resistance Adjustment Knob as described until the Flywheel is locked. Place the machine in a secure location away from children and pets.

With the Flywheel locked, the level of resistance will be out of the range of operation displayed by the Console. Do not use the machine with the level of resistance outside of the 0% - 100% range. This will damage the ability to quickly stop the Flywheel during an emergency, and the effectiveness of securing the bike for storage. Turn the Emergency Brake/Resistance Adjustment Knob until the LEVEL displayed on the Console is less than 100%. The resistance is now in the designed range of operation for the bike.

Changing Unit Measures (English Imperial/Metric)

The units of measurement can be switched between kilometers and miles before you start a workout. To change the units, push UP and DOWN together and hold 3 seconds. When the display begins to blink, use the arrow button to change the units (KM or MI). Push any button to save.

Troubleshooting

Condition/Problem	Things to Check	Solution
No display/partial display/ unit will not turn on	Check electrical (wall) outlet	Make sure unit is plugged into a functioning wall outlet.
	Check connection at front of unit	Connection should be secure and undamaged. Replace adapter or connection at unit if either are damaged.
	Check data cable integrity	All wires in cable should be intact. If any are visibly crimped or cut, replace cable.
	Check data cable connections/orientation	Be sure cable is connected securely and oriented properly. Small latch on connector should line up and snap into place.
	Check console display for damage	Check for visual sign that console display is cracked or otherwise damaged. Replace Console if damaged.
	Console Display	If Console only has partial display and all connections are fine, replace the Console.
		If the above steps do not resolve the problem, contact Customer Service (if inside US/Canada) or your local distributor (if outside US/Canada).
Speed displayed is not accurate	Check Speed Sensor Magnet position	Speed Sensor Magnet should be in place on Flywheel.
Speed displayed is always "0"/stuck in Pause mode	Data cable	Make sure the data cable is connected to the Console and the main frame assembly.
	Speed Sensor	Make sure the RPM Sensor Magnet and the RPM Sensor are in place.
No Speed/RPM reading	Check data cable integrity	All wires in cable should be intact. If any are cut or crimped, replace cable.
	Check data cable connections/orientation	Be sure cable is connected securely and oriented properly. Small latch on connector should line up and snap into place.
	Check Speed Sensor Magnet position	Speed Sensor Magnet should be in place on Flywheel.
	Check Speed Sensor Assembly	Speed Sensor Assembly should be aligned with magnet and connected to data cable. Realign sensor if necessary. Replace if there is any damage to the sensor or the connecting wire.
Unit operates but Bluetooth® Heart Rate (HR) not displayed	Bluetooth® Heart Rate Sensing Device (Armband provided with IC4)	Make sure device is directly against skin and contact area is wet.
	Bluetooth® Heart Rate Sensing Device Batteries	If device has replaceable batteries, install new batteries.
	Interference	Try moving unit away from sources of interference (TV, Microwave, etc).
	Replace Heart Rate Sensing Device	If interference is eliminated and HR does not function, replace device.
	Replace Console	If HR still does not function, replace Console.
Unit operates but Bluetooth® HR displayed incorrectly	Connected to previous user	The Console may be still connected to the previous user. Push Connect Bluetooth® button to disconnect from them/ connect to your Heart Rate Sensing Device.

Condition/Problem	Things to Check	Solution
Console shuts off (enters sleep mode) while in use	Check electrical (wall) outlet	Make sure unit is plugged into a functioning wall outlet.
	Check connection at front of unit	Connection should be secure and undamaged. Replace adapter or connection at unit if either are damaged.
	Check data cable integrity	All wires in the cable should be intact. If any are cut or crimped, replace cable.
	Check data cable connections/orientation	Be sure cable is connected securely and oriented properly. Small latch on connector should line up and snap into place.
	Reset machine	Unplug unit from electrical outlet for 3 minutes. Reconnect to outlet.
	Check magnet position (requires shroud removal)	Magnet should be in place on pulley.
	Check Speed Sensor (requires shroud removal)	Speed sensor should be aligned with magnet and connected to data cable. Realign sensor if necessary. Replace if there is any damage to the sensor or the connecting wire.
		Contact Customer Service (if inside US/Canada) or your local distributor (if outside US/Canada).
Unit rocks/does not sit level	Check level adjustment	Levelers may be turned to level machine.
	Check surface under unit	Adjustment may not be able to compensate for extremely uneven surfaces. Move machine to level area.
Pedals loose/unit difficult to pedal/ Pedals seem to skip or slip with a sudden increase in rpm	Check pedal to crank connection	Pedal should be tightened securely to crank arm. Be sure connection is not cross-threaded.
	Check crank arm to axle connection	Crank arm should be tightened securely to axle.
	Check drive belt tension	Refer to the "Adjust the Belt Tension" procedure in the Service Manual. Contact Customer Service (if inside US/Canada) or your local distributor (if outside US/Canada).
Clicking sound when pedaling	Check pedal to crank connection	Remove pedals. Make sure there is no debris on threads, and reinstall the pedals.
Seat post movement	Check locking pin	Be sure adjustment pin is locked into one of the seat post adjustment holes.
	Check locking knob	Be sure knob is securely tightened.

Maintenance Parts

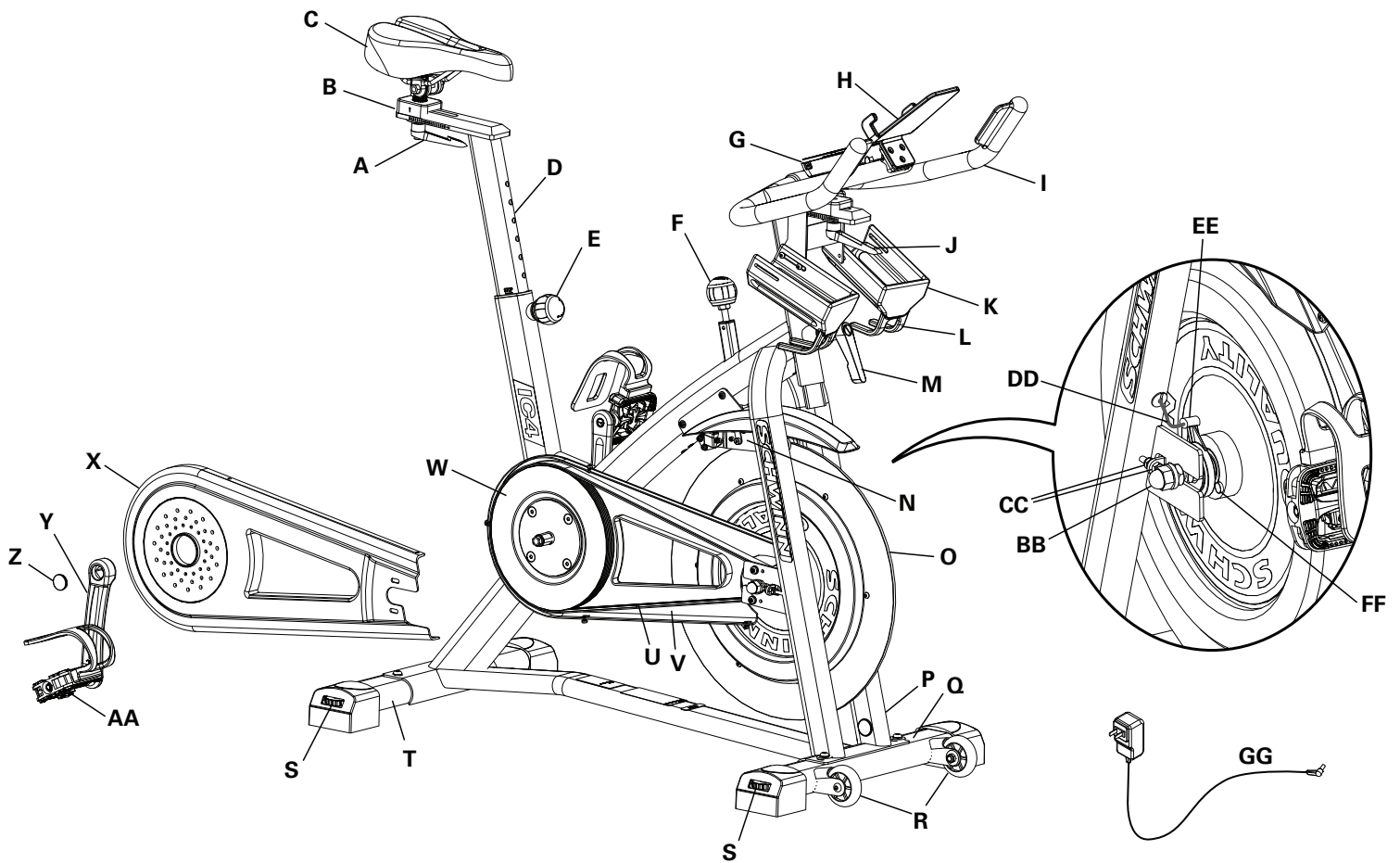

A	Adjustment Handle	L	Dumbbell Rack (Dumbbells only supplied with the IC4 machine)	W	Drive Pulley
B	Adjustment Handle, Seat Slider	M	Adjustment Handle, Handlebar Post	X	Cover, Drive Belt
C	Seat	N	Brake Assembly	Y	Crank Arm
D	Seat Post	O	Flywheel	Z	Crank Cap
E	Seat Post Adjustment Knob	P	Power Inlet	AA	Pedal w/Foot Restraint
F	Brake/Resistance Knob	Q	Front Stabilizer	BB	Axle Nut
G	Console	R	Transport Wheel	CC	Flywheel Retainer Nut
H	Media Tray	S	Leveler	DD	Data Cable
I	Handlebar	T	Rear Stabilizer	EE	Speed Sensor
J	Adjustment Handle, Handlebar Slider	U	Drive Belt	FF	Speed Sensor Magnet
K	Water Bottle Holder	V	Cover, Drive Belt Inside	GG	AC Adapter

REPLACEMENT PROCEDURE SKILL LEVEL

Level I : Low - very little mechanical knowledge or exposure.

Level II : Intermediate - some experience with mechanical procedures

Level III : Advanced - knowledgeable about mechanical procedures



Disconnect all power to the machine before you service it.

When disposing of old parts, obey the applicable local and provincial requirements.

For instructions to replace the following parts, please refer to the Assembly Manual for your bike:

- Console
- Front Stabilizer
- Handlebar
- Handlebar Post
- Pedals
- Rear Stabilizer
- Seat
- Seat Post
- Water Bottle Holders

NOTICE: This document provides instructions for the adjustment of the Drive Belt Tension on the Schwinn™ IC4 / IC8 / 800IC and Bowflex™ C6 Bikes.

If you need assistance, please call Nautilus Customer Service (if purchased in US/Canada) or your local distributor (if purchased outside US/Canada). To find your local distributor, go to: www.nautilusinternational.com

⚠ This icon means a potentially hazardous situation which, if not avoided, could result in death or serious injury. Read and understand all Warnings on this machine.

Nautilus, Inc., www.NautilusInc.com, 5415 Centerpoint Parkway, Groveport, OH 43125 U.S.A. - Customer Service: North America (800) 605-3369, csnl@nautilus.com | outside U.S. www.nautilusinternational.com | Printed in China | © 2019 Nautilus, Inc. | Nautilus, the Nautilus logo, Bowflex and Schwinn are trademarks owned by or licensed to Nautilus, Inc., which are registered or otherwise protected by common law in the United States and other countries. | ORIGINAL DOCUMENT - ENGLISH VERSION ONLY

Important Safety Instructions - Before servicing or using this equipment, obey the following warnings:

⚠ This icon means a potentially hazardous situation which, if not avoided, could result in death or serious injury. Read and understand all Warnings on this machine.

- Read and understand the Part Replacement Procedure before working on the machine. Failure to obey the instructions and safety warnings could cause injury to the service technician or bystanders.
- Keep bystanders and children away from the product being serviced at all times.
- Disconnect all power to the machine before you service it.
- Make sure that the repair is done in an appropriate work space away from foot traffic and exposure to bystanders.
- Some components of the equipment can be heavy or awkward. Enlist the service of a second person when you do maintenance steps involving these components. Do not try to do heavy or awkward steps on your own.
- Use only replacement parts and hardware that are supplied or approved by Nautilus. Failure to use Nautilus-approved replacement parts can adversely affect the safety and functionality of the equipment creating a risk to users and will void the warranty.
- Be sure that all warning stickers and instructional placards applied to the product stay present and in good condition when doing maintenance or replacing components. If at any time the Warning labels become loose, unreadable or dislodged, replace the labels. If purchased in US/Canada, contact Customer Service for replacement labels. If purchased outside US/Canada, contact your local distributor for them.
- Do not try to change the design or functionality of the machine being serviced as this can adversely affect user safety.
- Do not use the machine until all shrouds, instructions, warning labels and correct functionality have been verified and tested for correct performance.

• SAVE THESE INSTRUCTIONS

Tools Required (not included)

#2 Phillips screwdriver



15mm Wrench
10mm Wrench

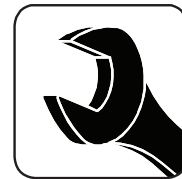

Flathead screwdriver



16mm Socket and Wrench
15mm Socket and Wrench



25mm Crank puller

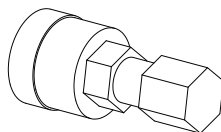

Red Loctite® 272 or equivalent
(high strength)



Note: Your machine may not match the images provided exactly.

1. Unplug the AC Adapter from the wall outlet and machine.



Keep the flywheel stable during this procedure. Do not turn the crank arms. Flywheel movement can pull fingers in and cause injury.

2. To test the Drive Belt tension, sit on the bike and use the pedals at approximately 20 RPM. Then accelerate quickly (speed burst) to your maximum ability and feel whether the Drive Belt slips. If the pedals move normally with no skipping (slip), the tension is correct.

If the tension is correct—got to step 14.

If the Drive Belt slips—continue to step 3.

3. Using a flathead screwdriver, remove the threaded Cap from the right Crank Arm.



4. Using a 16mm socket and wrench, remove the Flange Nut under the threaded Cap.

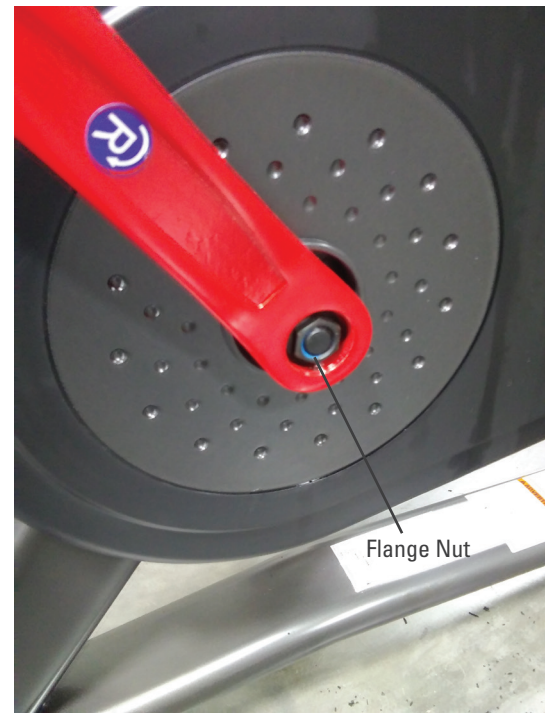

5. Thread the Crank Puller into the Crank Arm. When the Crank Puller is in the correct position, only 1-2 threads on the outer portion (CP2) of the Crank Puller should show.

Note: Be sure the end of the Bolt (CP1) in the Crank Puller is flush with the inner surface (CP2) as shown, before use.

6. Using a 15mm wrench, turn the inner portion (CP3) of the Crank Puller clockwise. The Crank Arm will slide off as it is tightened.

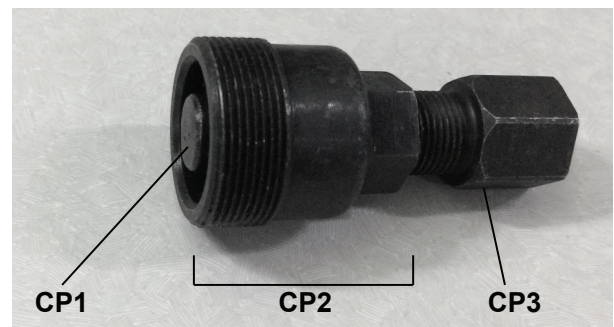

7. Using a #2 Phillips screwdriver, remove the indicated hardware from the Drive Belt Cover. Carefully remove the Drive Belt Cover and set it safely aside for reassembly.

Note: The oval indicates the two machine screws with washers.

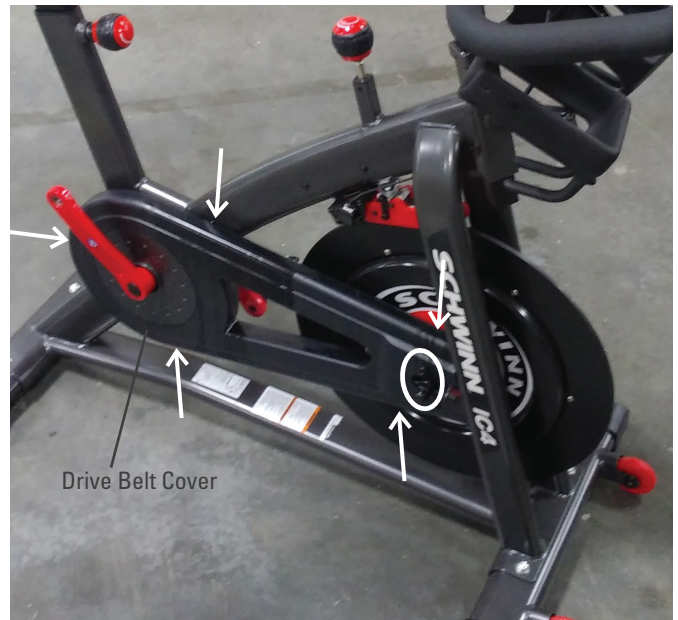

Note: Please disregard the Right Crank Arm in the above image. It was removed during an earlier step.

8. Use a 15mm open end wrench to hold the Flywheel Axle Nut on one side steady and loosen the Flywheel Axle Nut on the opposite side with a 15mm socket and wrench.



Be sure to keep fingers clear of all pinch hazards.

9. Check the tension:

- Push the Drive Belt downward at the midpoint (M) between the pulleys and measure the distance. The Drive Belt should have only 0.25" (0.64 cm) of give.

Or:

- Hold the edges of the Drive Belt at the midpoint (M) and twist it. It should turn only 90 degrees (1/4 turn, to vertical).

If the Drive Belt is too loose—use a 10mm wrench to turn each Flywheel Retainer Nut 1/4 turn to the right.

If the Drive Belt is too tight—use a 10mm wrench to turn each Flywheel Retainer Nut 1/4 turn to the left.

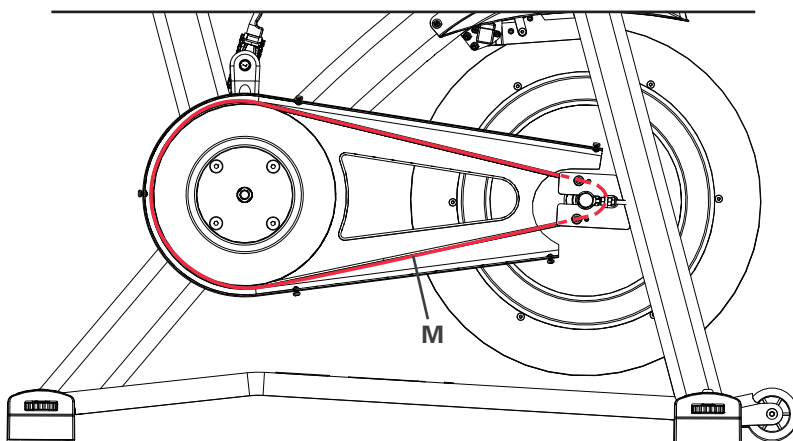

10. Reinstall the right Crank Arm and Pedal. Installation does not require the use of the crank puller. Be sure the Crank Arms are connected at 180° from each other.

11. Get on the bike and check the movement of the Drive Belt by rocking back and forth on the pedals. The Pedals and Flywheel should move as one.

Adjust the Drive Belt tension again if necessary.

12. Tighten the Axle Nuts when the Drive Belt tension is correct.

NOTICE: Make sure the Flywheel is aligned with the Frame. Be sure the Flywheel Axle does not touch the Drive Belt inside.

13. Remove the right Pedal and Crank Arm. Reinstall the Drive Belt Cover, Crank Arm and Pedal.

14. Add Loctite® 272 (or equivalent) to the inner threads of the Crank Nuts. Do not to apply the Loctite® 272 to the Crank Shaft.

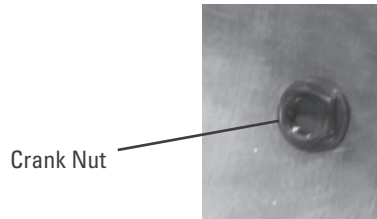

15. Install the Crank Nut onto the Crank Shaft, and fully tighten it.

16. Replace the threaded Cap onto the Crank Arm.

17. Final Inspection

Inspect your machine to ensure that all hardware is tight and components are properly assembled.



Do not use until the machine has been fully assembled and inspected for correct performance in accordance with the Owner's Manual.

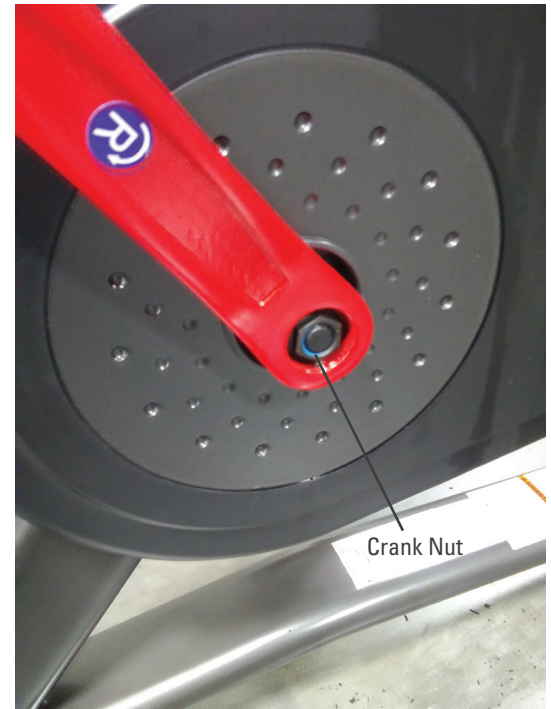

NOTICE: This document provides instructions to calibrate the Magnetic Resistance Sensor on the Schwinn™ IC4 / IC8 / 800IC and Bowflex™ C6 Bikes. This procedure may be useful if:

- the Resistance Knob can be rotated, and the Level value on the Console never changes from 0%.
- the Resistance Knob can be fully rotated counter-clockwise, and the Level value never reaches 0%.
- the Resistance Knob is fully rotated clockwise, and the Level value never reaches 100%.

Note: Be sure to confirm that all cable connections are secure before performing the calibration. Due to product limitations, the Magnetic Resistance Sensor can only be calibrated three times.

If you need assistance, please call Nautilus Customer Service (if purchased in US/Canada) or your local distributor (if purchased outside US/Canada). To find your local distributor, go to: www.nautilusinternational.com



This icon means a potentially hazardous situation which, if not avoided, could result in death or serious injury. Read and understand all Warnings on this machine.

Nautilus, Inc., www.NautilusInc.com, 5415 Centerpoint Parkway, Groveport, OH 43125 U.S.A. - Customer Service: North America (800) 605-3369, csnls@nautilus.com | outside U.S. www.nautilusinternational.com | Printed in China | © 2020 Nautilus, Inc. | Nautilus, the Nautilus logo, Bowflex and Schwinn are trademarks owned by or licensed to Nautilus, Inc., which are registered or otherwise protected by common law in the United States and other countries. | ORIGINAL DOCUMENT - ENGLISH VERSION ONLY

Important Safety Instructions - Before servicing or using this equipment, obey the following warnings:



This icon means a potentially hazardous situation which, if not avoided, could result in death or serious injury. Read and understand all Warnings on this machine.

- Read and understand the Part Replacement Procedure before working on the machine. Failure to obey the instructions and safety warnings could cause injury to the service technician or bystanders.
- Keep bystanders and children away from the product being serviced at all times.
- Disconnect all power to the machine before you service it.
- Make sure that the repair is done in an appropriate work space away from foot traffic and exposure to bystanders.
- Some components of the equipment can be heavy or awkward. Enlist the service of a second person when you do maintenance steps involving these components. Do not try to do heavy or awkward steps on your own.
- Use only replacement parts and hardware that are supplied or approved by Nautilus. Failure to use Nautilus-approved replacement parts can adversely affect the safety and functionality of the equipment creating a risk to users and will void the warranty.
- Be sure that all warning stickers and instructional placards applied to the product stay present and in good condition when doing maintenance or replacing components. If at any time the Warning labels become loose, unreadable or dislodged, replace the labels. If purchased in US/Canada, contact Customer Service for replacement labels. If purchased outside US/Canada, contact your local distributor for them.
- Do not try to change the design or functionality of the machine being serviced as this can adversely affect user safety.
- Do not use the machine until all shrouds, instructions, warning labels and correct functionality have been verified and tested for correct performance.

• SAVE THESE INSTRUCTIONS

1. With the Console activated and in Power-Up mode, push the START/ENTER button.

2. Within 5 seconds of completing Step 1, push and hold down the Reset and Increase buttons for 3 seconds. The Console is now in Service Mode.

3. Now push and hold down the Reset and Increase buttons again for 3 seconds. The Console is now in the Calibrate the Magnetic Resistance Sensor option (display with placeholders shown).

4. The Console displays four values with one of them flashing.

Note: The Magnetic Resistance Sensor can only be calibrated three times. If the Console displays the Calibration Round as “3”, then it cannot be calibrated again.

The upper value is the current position supplied by the Resistance Knob. This is the value controlled by the user.

The 1% Configured Value is the previously calibrated position for the 1% Resistance Value. This value is the first to be calibrated and is the one flashing.

Turn the Resistance Knob counter-clockwise until it is unable to turn, and then turn it clockwise a quarter of a turn.

5. Push the START/ENTER button to set this value as the new 1% Configured Value. The Console will update the displayed value.

6. The Console will now flash the 100% Configured Value. The 100% Configured Value is the previously calibrated position for the 100% Resistance Value.

With one hand on the front of the Flywheel, slightly turn the Flywheel while turning the Resistance Knob clockwise. Immediately stop turning the Resistance Knob when the Flywheel is unable to turn.

 **Be sure to keep fingers clear of all pinch hazards as you slightly turn the Flywheel.**

7. Turn the Resistance Knob counter-clockwise one full turn.

8. Confirm that the Flywheel can move by turning it. If the Flywheel cannot turn, the Resistance Knob has been turned too far. Go back to Step 6.

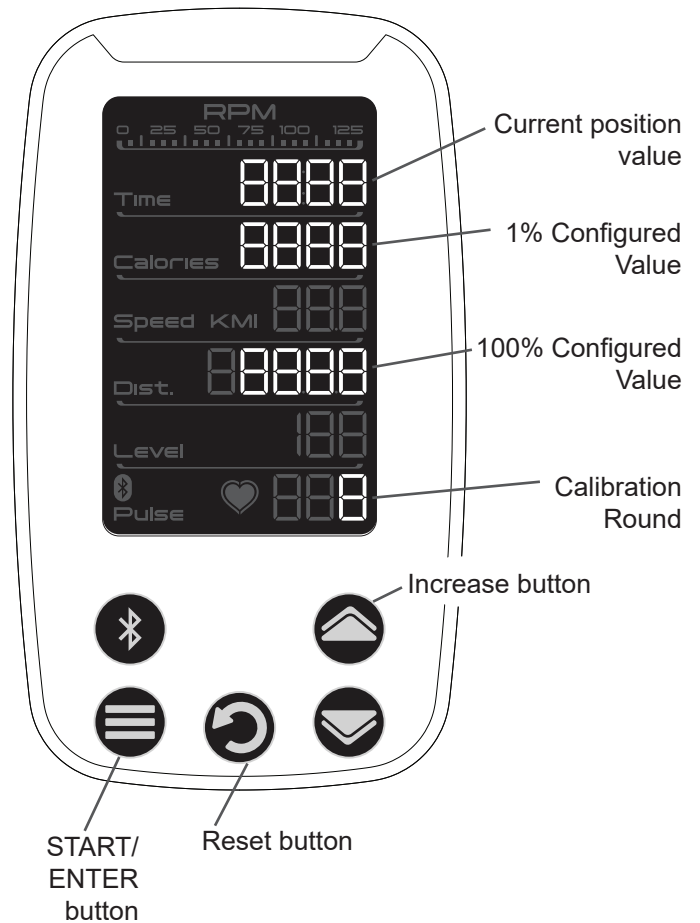

9. Push the START/ENTER button to set this value as the new 100% Configured Value. The Console will update the displayed value.

10. Unplug the machine from the power adapter for 5 minutes, and then plug it back into the machine. The Console will activate with the Magnetic Resistance Sensor calibrated to the new positions.

NOTICE: This document provides instructions for the installation of the Handlebar Bushing Kit on the Schwinn™ IC4 / IC8 / 800IC and Bowflex™ C6 Bikes. This procedure may be useful if the Handlebars cannot be locked into place.

If you need assistance, please call Nautilus Customer Service (if purchased in US/Canada) or your local distributor (if purchased outside US/Canada). To find your local distributor, go to: www.nautilusinternational.com

This icon means a potentially hazardous situation which, if not avoided, could result in death or serious injury. Read and understand all Warnings on this machine.

Nautilus, Inc., www.NautilusInc.com, 5415 Centerpoint Parkway, Groveport, OH 43125 U.S.A. - Customer Service: North America (800) 605-3369, csnls@nautilus.com | outside U.S. www.nautilusinternational.com | Printed in China | © 2020 Nautilus, Inc. | Nautilus, the Nautilus logo, Bowflex and Schwinn are trademarks owned by or licensed to Nautilus, Inc., which are registered or otherwise protected by common law in the United States and other countries. | ORIGINAL DOCUMENT - ENGLISH VERSION ONLY

Important Safety Instructions - Before servicing or using this equipment, obey the following warnings:

This icon means a potentially hazardous situation which, if not avoided, could result in death or serious injury. Read and understand all Warnings on this machine.

- Read and understand the Part Replacement Procedure before working on the machine. Failure to obey the instructions and safety warnings could cause injury to the service technician or bystanders.
- Keep bystanders and children away from the product being serviced at all times.
- Disconnect all power to the machine before you service it.
- Make sure that the repair is done in an appropriate work space away from foot traffic and exposure to bystanders.
- Some components of the equipment can be heavy or awkward. Enlist the service of a second person when you do maintenance steps involving these components. Do not try to do heavy or awkward steps on your own.
- Use only replacement parts and hardware that are supplied or approved by Nautilus. Failure to use Nautilus-approved replacement parts can adversely affect the safety and functionality of the equipment creating a risk to users and will void the warranty.
- Be sure that all warning stickers and instructional placards applied to the product stay present and in good condition when doing maintenance or replacing components. If at any time the Warning labels become loose, unreadable or dislodged, replace the labels. If purchased in US/Canada, contact Customer Service for replacement labels. If purchased outside US/Canada, contact your local distributor for them.
- Do not try to change the design or functionality of the machine being serviced as this can adversely affect user safety.
- Do not use the machine until all shrouds, instructions, warning labels and correct functionality have been verified and tested for correct performance.

• SAVE THESE INSTRUCTIONS

Tools Required (not included)

Small Standard Screwdriver



32mm Wrench (or Adjustable)



Kit Parts (included)

Threaded Cap



Wedge Bushing



Note: Your machine may not match the images provided exactly.

1. Unplug the AC Adapter from the wall outlet and machine.
2. Fully turn the Resistance Knob clockwise to lock the Flywheel into place.
3. Remove the Dumbbells from the Handlebars if they are in place on the Dumbbell Rack.



4. Disconnect the Cables that connect the Console to the Frame Assembly.

NOTICE: Do not crimp any cables.

5. Being prepared to support the Handlebars, loosen the Handlebar Post Adjustment Handle and remove the Handlebar Assembly from the Frame Assembly. Set the Handlebar Assembly safely aside away from the work area.

6. Remove the Handlebar Post Adjustment Handle from the Frame Assembly.



7. Using a 32mm Open Faced Wrench or an Adjustable Wrench, remove the Threaded Cap from the Frame Assembly.



8. Use the small standard screwdriver to remove the Wedge Bushing exposed behind the Threaded Cap from the Frame Assembly, or safely tilt the machine until the Wedge Bushing falls from the Frame Assembly.

Note: Be sure to notice how the Wedge Bushing engages within the Frame Assembly to assist with re-assembly.

9. Dispose of the old Wedge Bushing and Threaded Cap.

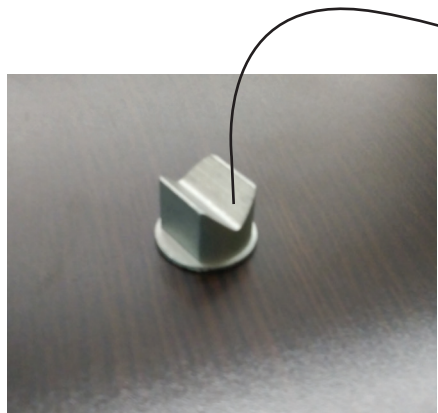

10. Re-install all remaining parts that were removed in reverse order.

11. Final Inspection

Inspect your machine to ensure that all hardware is tight and components are properly assembled.



Do not use until the machine has been fully assembled and inspected for correct performance in accordance with the Owner's Manual.

NOTICE: This document provides instructions for the replacement of the Emergency Brake Pad on the Schwinn™ IC4 / IC8 / 800iC and Bowflex™ C6 Bikes.

If you need assistance, please call Nautilus Customer Service (if purchased in US/Canada) or your local distributor (if purchased outside US/Canada). To find your local distributor, go to: www.nautilusinternational.com

 **This icon means a potentially hazardous situation which, if not avoided, could result in death or serious injury. Read and understand all Warnings on this machine.**

Nautilus, Inc., www.NautilusInc.com, 5415 Centerpoint Parkway, Groveport, OH 43125 U.S.A. - Customer Service: North America (800) 605-3369, csnls@nautilus.com | outside U.S. www.nautilusinternational.com | Printed in China | © 2019 Nautilus, Inc. | Nautilus, the Nautilus logo, Bowflex and Schwinn are trademarks owned by or licensed to Nautilus, Inc., which are registered or otherwise protected by common law in the United States and other countries. | ORIGINAL DOCUMENT - ENGLISH VERSION ONLY

Important Safety Instructions - Before servicing or using this equipment, obey the following warnings:

 **This icon means a potentially hazardous situation which, if not avoided, could result in death or serious injury. Read and understand all Warnings on this machine.**

- Read and understand the Part Replacement Procedure before working on the machine. Failure to obey the instructions and safety warnings could cause injury to the service technician or bystanders.
- Keep bystanders and children away from the product being serviced at all times.
- Disconnect all power to the machine before you service it.
- Make sure that the repair is done in an appropriate work space away from foot traffic and exposure to bystanders.
- Some components of the equipment can be heavy or awkward. Enlist the service of a second person when you do maintenance steps involving these components. Do not try to do heavy or awkward steps on your own.
- Use only replacement parts and hardware that are supplied or approved by Nautilus. Failure to use Nautilus-approved replacement parts can adversely affect the safety and functionality of the equipment creating a risk to users and will void the warranty.
- Be sure that all warning stickers and instructional placards applied to the product stay present and in good condition when doing maintenance or replacing components. If at any time the Warning labels become loose, unreadable or dislodged, replace the labels. If purchased in US/Canada, contact Customer Service for replacement labels. If purchased outside US/Canada, contact your local distributor for them.
- Do not try to change the design or functionality of the machine being serviced as this can adversely affect user safety.
- Do not use the machine until all shrouds, instructions, warning labels and correct functionality have been verified and tested for correct performance.

• SAVE THESE INSTRUCTIONS

Tools Required (not included)

#2 Phillips screwdriver

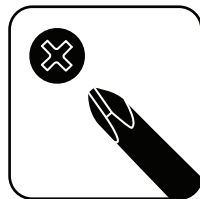

7mm Wrench

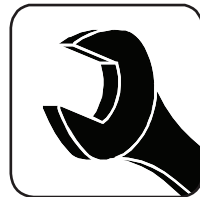

3mm Hex wrench

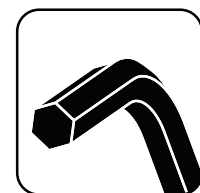

Note: Your machine may not match the images provided exactly.

1. Unplug the AC Adapter from the wall outlet and machine.
2. Using a #2 Phillips screwdriver, loosen and remove the hardware that attaches the Fender to the Main Frame. Set the Fender and hardware safely aside for reassembly.
NOTICE: Hold the Brake Cover so that it does not fall.
3. Loosen the Resistance Knob to the minimum resistance setting.



4. Loosen and remove the hardware (indicated by arrows) that attaches the Emergency Brake Pad to the Brake Assembly.
5. Slide the old Emergency Brake Pad out of the Brake Assembly.



6. Install the new Emergency Brake Pad into the Brake Assembly. Be sure to install the Emergency Brake Pad so that the thicker part of the Emergency Brake Pad is toward the front of the bike.

NOTICE: Do not crimp the cable.

Note: To assist with getting the hardware started, insert the hex wrench into the opening of the Emergency Brake Pad to keep it in place and install the hardware from the other side.

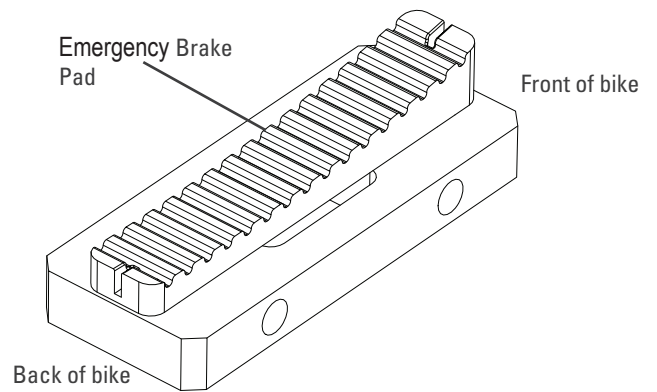

7. Reinstall the Fender.

NOTICE: Do not crimp the cable.

8. Adjust the Resistance Knob as necessary.

9. Final Inspection

Inspect your machine to ensure that all hardware is tight and components are properly assembled.



Do not use until the machine has been fully assembled and inspected for correct performance in accordance with the Owner's Manual.

NOTICE: This document provides instructions for the replacement of the Brake / Resistance Knob Assembly on the Schwinn™ IC4 / IC8 / 800IC and Bowflex™ C6 Bikes.

If you need assistance, please call Nautilus Customer Service (if purchased in US/Canada) or your local distributor (if purchased outside US/Canada). To find your local distributor, go to: www.nautilusinternational.com

 **This icon means a potentially hazardous situation which, if not avoided, could result in death or serious injury. Read and understand all Warnings on this machine.**

Nautilus, Inc., www.NautilusInc.com, 5415 Centerpoint Parkway, Groveport, OH 43125 U.S.A. - Customer Service: North America (800) 605-3369, csnls@nautilus.com | outside U.S. www.nautilusinternational.com | Printed in China | © 2019 Nautilus, Inc. | Nautilus, the Nautilus logo, Bowflex and Schwinn are trademarks owned by or licensed to Nautilus, Inc., which are registered or otherwise protected by common law in the United States and other countries. | ORIGINAL DOCUMENT - ENGLISH VERSION ONLY

Important Safety Instructions - Before servicing or using this equipment, obey the following warnings:

 **This icon means a potentially hazardous situation which, if not avoided, could result in death or serious injury. Read and understand all Warnings on this machine.**

- Read and understand the Part Replacement Procedure before working on the machine. Failure to obey the instructions and safety warnings could cause injury to the service technician or bystanders.
- Keep bystanders and children away from the product being serviced at all times.
- Disconnect all power to the machine before you service it.
- Make sure that the repair is done in an appropriate work space away from foot traffic and exposure to bystanders.
- Some components of the equipment can be heavy or awkward. Enlist the service of a second person when you do maintenance steps involving these components. Do not try to do heavy or awkward steps on your own.
- Use only replacement parts and hardware that are supplied or approved by Nautilus. Failure to use Nautilus-approved replacement parts can adversely affect the safety and functionality of the equipment creating a risk to users and will void the warranty.
- Be sure that all warning stickers and instructional placards applied to the product stay present and in good condition when doing maintenance or replacing components. If at any time the Warning labels become loose, unreadable or dislodged, replace the labels. If purchased in US/Canada, contact Customer Service for replacement labels. If purchased outside US/Canada, contact your local distributor for them.
- Do not try to change the design or functionality of the machine being serviced as this can adversely affect user safety.
- Do not use the machine until all shrouds, instructions, warning labels and correct functionality have been verified and tested for correct performance.

• SAVE THESE INSTRUCTIONS

Tools Required (not included)

#2 Phillips screwdriver

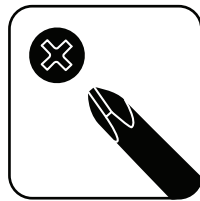

5mm Hex wrench



10mm Open end wrench
or adjustable wrench

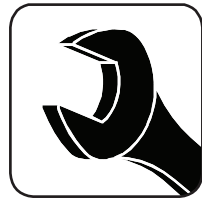

Small (2-3mm) steel pin and hammer



Note: Your machine may not match the images provided exactly.

1. Unplug the AC Adapter from the wall outlet and machine.

 **Keep the flywheel stable during this procedure. Do not turn the crank arms. Flywheel movement can pull fingers in and cause injury.**

2. Using a #2 Phillips screwdriver, loosen and remove the hardware that attaches the Fender to the Main Frame. Set the hardware safely aside for reassembly.

NOTICE: Hold the Fender so that it does not fall.

3. Loosen the Resistance Knob to the minimum resistance setting.



4. Using a small (2-3mm) steel pin and hammer, push the Roll Pin out of the Collar and Resistance Adjustment Shaft. You may need to push down slightly on the Resistance Knob at the same time.

5. Turn the Resistance Knob in the direction to increase resistance until the tip of the threaded Resistance Adjustment Shaft comes out of the Resistance Nut.



6. Pull quickly and sharply up on the Resistance Knob to pop the plastic top cap out of the steel tube and remove the Resistance Knob and Shaft. Note the spring and some spacers may remain in the square steel tube. These can be retrieved with a magnet tool or turning the bike upside down.

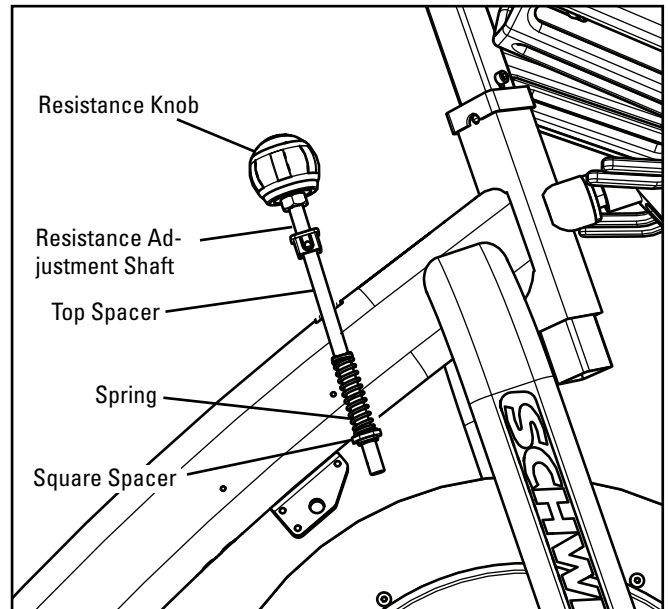

7. Using a #2 Phillips screwdriver, remove the hardware (indicated by ovals) that secures the Resistance Sensor. Allow the Resistance Sensor to hang from the Cable.

NOTICE: Do not crimp the cable.



8. Remove the Resistance Sensor Magnet after noting the flat segments are oriented up and downward. This will assist with re-assembly.



9. Using a 10mm open end wrench and a 5mm hex wrench, remove the hardware (indicated by arrows) from both sides of the machine.



10. Installation is the reverse procedure. Carefully turn the new Resistance Knob clockwise to install it through the Top Spacer, Spring and Square Spacer inside the mount tube.

Note: Hold the Square Spacer and Spring so that the Spring touches the Top Spacer inside the square mount, until the Shaft is threaded through the Square Spacer.

11. Final Inspection

Inspect your machine to ensure that all hardware is tight and components are properly assembled.



Do not use until the machine has been fully assembled and inspected for correct performance in accordance with the Owner's Manual.

NOTICE: This document provides instructions for the replacement of the Crank Arm on the Schwinn™ IC4 / IC8 / 800IC and Bowflex™ C6 Bikes.

⚠ When replacing the Pedals into the Crank Arms, if the threads strip due to improper installation then the Pedals can disengage from the bike and/or break while under usage, which can result in serious injury to the user.

Note: The Left Pedal is reverse-threaded. Be sure to attach the Pedals on the proper side of the bike. Orientation is based from a seated position on the bike. The Left Pedal has an "L", the Right Pedal an "R".

If you need assistance, please call Nautilus Customer Service (if purchased in US/Canada) or your local distributor (if purchased outside US/Canada). To find your local distributor, go to: www.nautilusinternational.com

⚠ This icon means a potentially hazardous situation which, if not avoided, could result in death or serious injury. Read and understand all Warnings on this machine.

Nautilus, Inc., www.NautilusInc.com, 5415 Centerpoint Parkway, Groveport, OH 43125 U.S.A. - Customer Service: North America (800) 605-3369, csnls@nautilus.com | outside U.S. www.nautilusinternational.com | Printed in China | © 2019 Nautilus, Inc. | Nautilus, the Nautilus logo, Bowflex and Schwinn are trademarks owned by or licensed to Nautilus, Inc., which are registered or otherwise protected by common law in the United States and other countries. Other trademarks are the property of their respective owners. | ORIGINAL DOCUMENT - ENGLISH VERSION ONLY

Important Safety Instructions - Before servicing or using this equipment, obey the following warnings:

⚠ This icon means a potentially hazardous situation which, if not avoided, could result in death or serious injury. Read and understand all Warnings on this machine.

- Read and understand the Part Replacement Procedure before working on the machine. Failure to obey the instructions and safety warnings could cause injury to the service technician or bystanders.
- Keep bystanders and children away from the product being serviced at all times.
- Disconnect all power to the machine before you service it.
- Make sure that the repair is done in an appropriate work space away from foot traffic and exposure to bystanders.
- Some components of the equipment can be heavy or awkward. Enlist the service of a second person when you do maintenance steps involving these components. Do not try to do heavy or awkward steps on your own.
- Use only replacement parts and hardware that are supplied or approved by Nautilus. Failure to use Nautilus-approved replacement parts can adversely affect the safety and functionality of the equipment creating a risk to users and will void the warranty.
- Be sure that all warning stickers and instructional placards applied to the product stay present and in good condition when doing maintenance or replacing components. If at any time the Warning labels become loose, unreadable or dislodged, replace the labels. If purchased in US/Canada, contact Customer Service for replacement labels. If purchased outside US/Canada, contact your local distributor for them.
- Do not try to change the design or functionality of the machine being serviced as this can adversely affect user safety.
- Do not use the machine until all shrouds, instructions, warning labels and correct functionality have been verified and tested for correct performance.

• SAVE THESE INSTRUCTIONS

Tools Required (not included)

Flathead screwdriver



25mm Crank puller

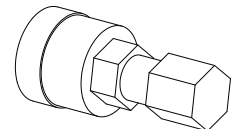

16mm Socket and Wrench



15mm Wrench
or adjustable wrench



Red Loctite® 272 or equivalent
(high strength)



Blue Loctite® 242 or equivalent
(medium strength)



Note: Your machine may not match the images provided exactly.

1. Unplug the AC Adapter from the wall outlet and machine.
2. Loosen and remove the Pedal. Set it safely aside for reassembly.

Note: The Left Pedal is reverse-threaded. Orientation is based from a seated position on the bike. The Left Pedal has an "L", the Right Pedal an "R".

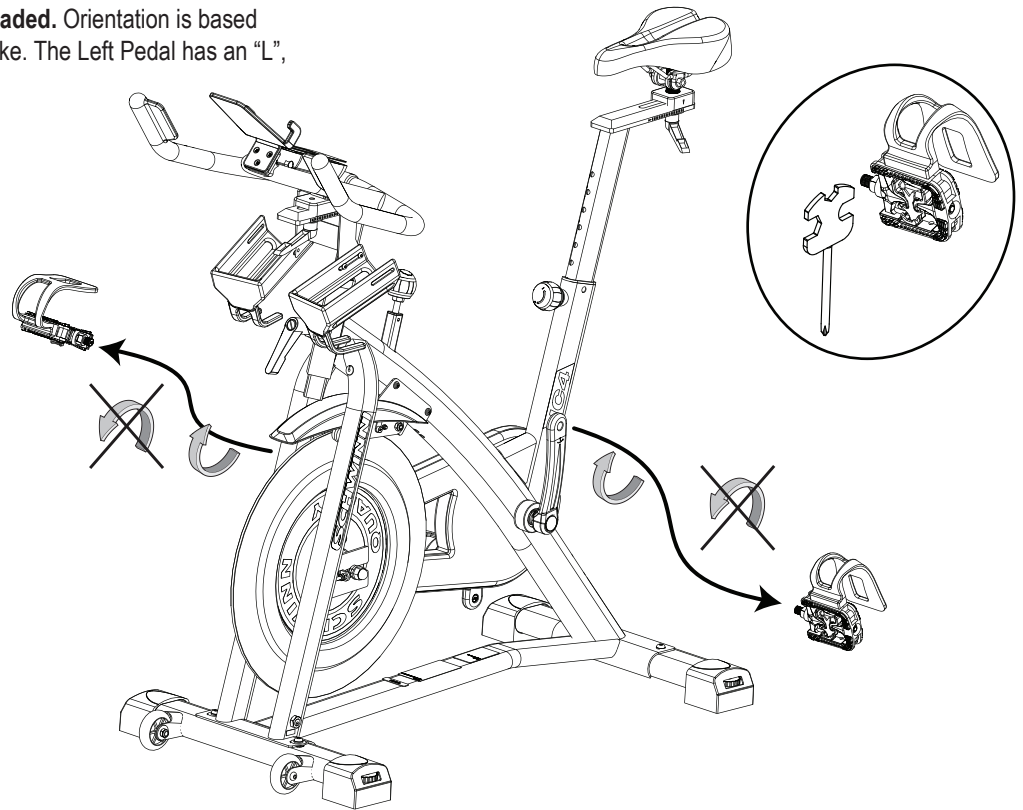

3. Using a flathead screwdriver, remove the threaded Cap from the Crank Arm.



4. Using a 16mm socket and wrench, remove the Crank Nut under the threaded Cap.

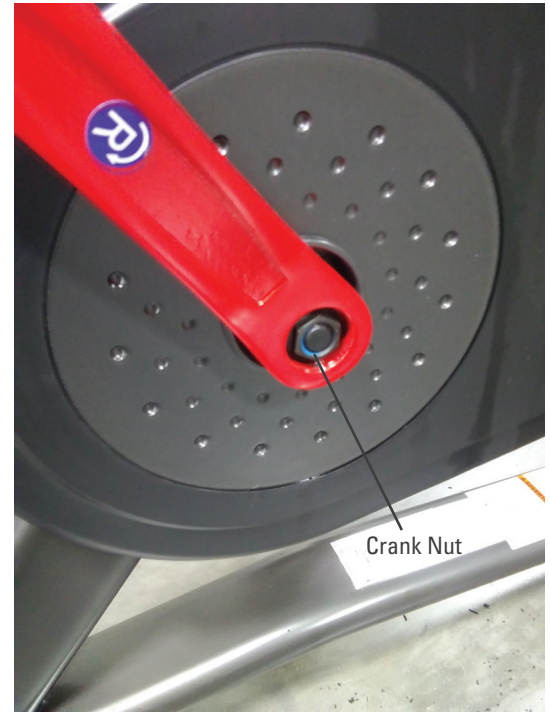

5. Thread the 25mm Crank Puller into the Crank Arm. When the Crank Puller is in the correct position, only 1-2 threads on the outer portion (CP2) of the Crank Puller should show.

Note: Be sure the end of the Bolt (CP1) in the Crank Puller is flush with the inner surface (CP2) as shown, before use.

6. Using a 15mm wrench, turn the inner portion (CP3) of the Crank Puller clockwise. The Crank Arm will slide off as it is tightened. Discard the old parts.

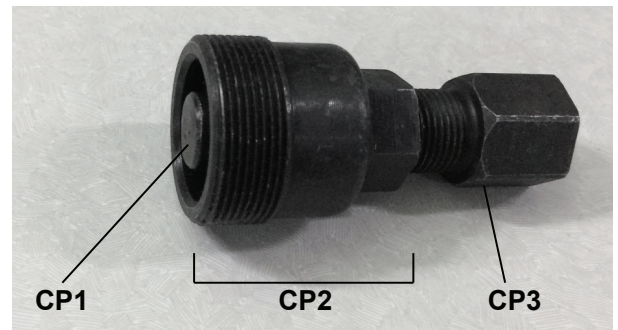

7. Place the new Crank Arms onto the Crank Shaft. Be sure the Crank Arms are connected at 180° from each other.

8. Add Loctite® 272 (or equivalent) to the inner threads of the Crank Nuts. Do not to apply the Loctite® 272 to the Crank Shaft.

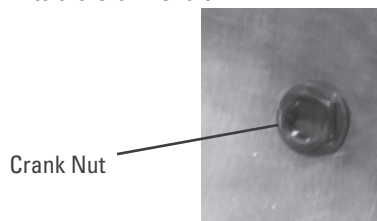

9. Install the Crank Nut onto the Crank Shaft, and fully tighten it. Repeat on the other side of the bike.

10. Apply Loctite® 242 (or equivalent) to the Pedal threads.

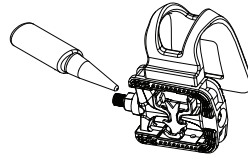

11. To reinstall a Pedal, start the Pedal by hand. If you feel resistance and the Pedal does not turn smoothly into the Crank Arm, make sure that the threads are aligned correctly. Be sure that the Pedal is going on straight into the Crank Arm. If the Pedal is not in-line with the opening, remove the Pedal and start again.

Note: The Left Pedal is reverse-threaded. Orientation is based from a seated position on the bike. The Left Pedal has an “L”, the Right Pedal an “R”.

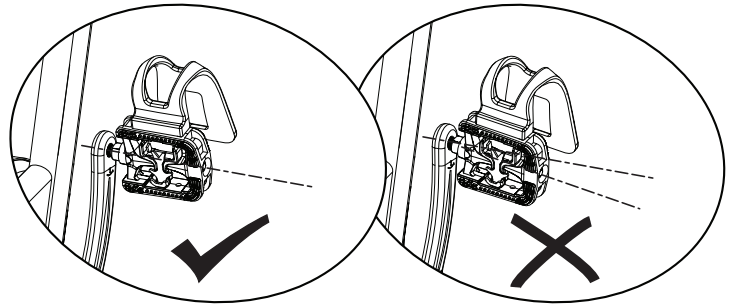

12. With the Pedal started by several hand turns into the Crank Arm, fully tighten it with the Pedal Wrench.

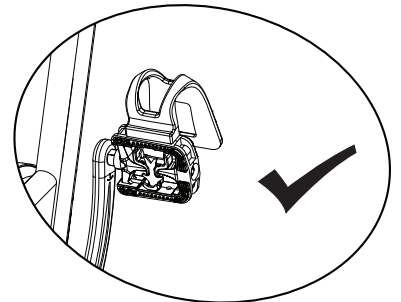
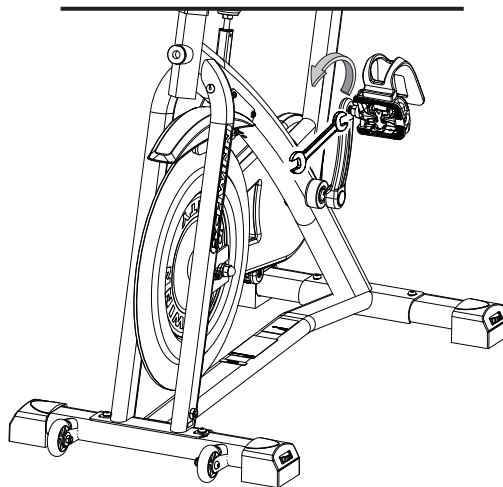

13. Confirm that the Pedal is fully tightened with the Pedal Wrench.

14. Repeat with the other Pedal.

Note: Be sure to check the Pedals weekly to confirm that they are fully tightened.



Since this machine operates with a fixed gear, do not back, or reverse, pedal. Doing so may loosen the Pedals, which could result in damage to the machine and/or injury to the user. Never operate this machine with loose Pedals.

15. Final Inspection

Inspect your machine to ensure that all hardware is tight and components are properly assembled.



Do not use until the machine has been fully assembled and inspected for correct performance in accordance with the Owner's Manual.

NOTICE: This document provides instructions for the replacement of the Drive Belt on the Schwinn™ IC4 / IC8 / 800IC and Bowflex™ C6 Bikes.

If you need assistance, please call Nautilus Customer Service (if purchased in US/Canada) or your local distributor (if purchased outside US/Canada). To find your local distributor, go to: www.nautilusinternational.com

⚠ This icon means a potentially hazardous situation which, if not avoided, could result in death or serious injury. Read and understand all Warnings on this machine.

Nautilus, Inc., www.NautilusInc.com, 5415 Centerpoint Parkway, Groveport, OH 43125 U.S.A. - Customer Service: North America (800) 605-3369, csnls@nautilus.com | outside U.S. www.nautilusinternational.com | Printed in China | © 2019 Nautilus, Inc. | Nautilus, the Nautilus logo, Bowflex and Schwinn are trademarks owned by or licensed to Nautilus, Inc., which are registered or otherwise protected by common law in the United States and other countries. | ORIGINAL DOCUMENT - ENGLISH VERSION ONLY

Important Safety Instructions - Before servicing or using this equipment, obey the following warnings:

⚠ This icon means a potentially hazardous situation which, if not avoided, could result in death or serious injury. Read and understand all Warnings on this machine.

- Read and understand the Part Replacement Procedure before working on the machine. Failure to obey the instructions and safety warnings could cause injury to the service technician or bystanders.
- Keep bystanders and children away from the product being serviced at all times.
- Disconnect all power to the machine before you service it.
- Make sure that the repair is done in an appropriate work space away from foot traffic and exposure to bystanders.
- Some components of the equipment can be heavy or awkward. Enlist the service of a second person when you do maintenance steps involving these components. Do not try to do heavy or awkward steps on your own.
- Use only replacement parts and hardware that are supplied or approved by Nautilus. Failure to use Nautilus-approved replacement parts can adversely affect the safety and functionality of the equipment creating a risk to users and will void the warranty.
- Be sure that all warning stickers and instructional placards applied to the product stay present and in good condition when doing maintenance or replacing components. If at any time the Warning labels become loose, unreadable or dislodged, replace the labels. If purchased in US/Canada, contact Customer Service for replacement labels. If purchased outside US/Canada, contact your local distributor for them.
- Do not try to change the design or functionality of the machine being serviced as this can adversely affect user safety.
- Do not use the machine until all shrouds, instructions, warning labels and correct functionality have been verified and tested for correct performance.

• SAVE THESE INSTRUCTIONS

Tools Required (not included)

#2 Phillips screwdriver



15mm Wrench
10mm Wrench



Flathead screwdriver

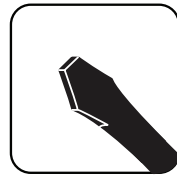

16mm Socket and Wrench
15mm Socket and Wrench



25mm Crank puller

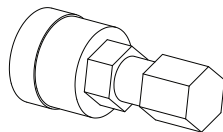

3.5mm Hex wrench
5mm Hex wrench



Red Loctite® 272 or equivalent
(high strength)



Tape or marking pen



NOTICE: At the end of this procedure, make sure that the Drive Belt tension is correct. Refer to the “Adjust the Belt Tension” procedure.

Note: Your machine may not match the image. For reference only.

1. Unplug the AC Adapter from the wall outlet and machine.



Keep the flywheel stable during this procedure. Do not turn the crank arms. Flywheel movement can pull fingers in and cause injury.

2. Using a flathead screwdriver, remove the threaded Cap from the Right Crank Arm.



3. Using a 16mm socket and wrench, remove the Crank Nut under the threaded Cap.

4. Thread the Crank Puller into the Crank Arm (A). When the Crank Puller is in the correct position, only 1-2 threads on the outer portion (CP2) of the Crank Puller should show.

Note: Be sure the end of the Bolt (CP1) in the Crank Puller is flush with the inner surface (CP2) as shown, before use.

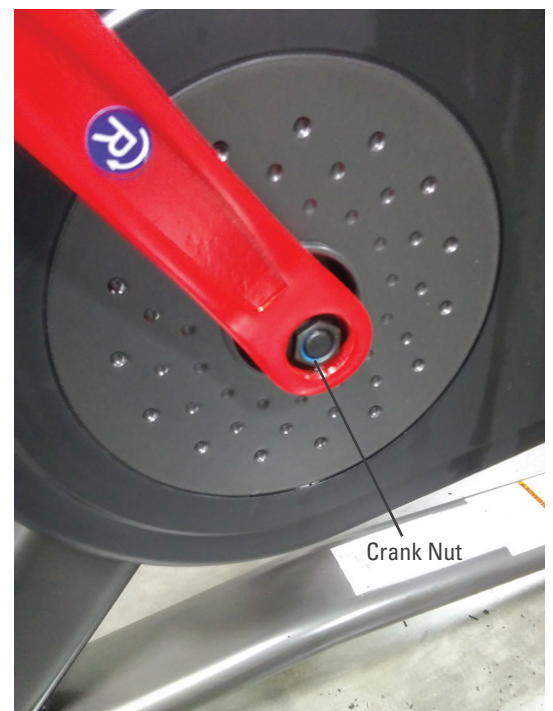
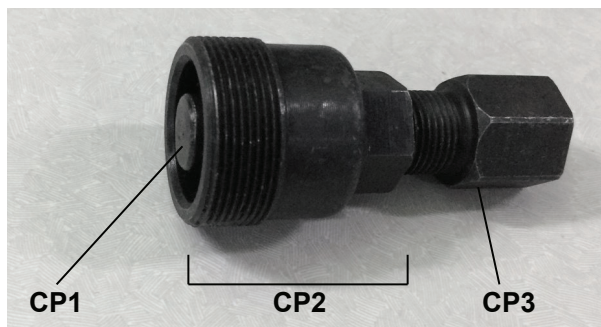

5. Using a 15mm wrench, turn the inner portion (CP3) of the Crank Puller clockwise. The Crank Arm will slide off as it is tightened.

6. Using a #2 Phillips screwdriver, loosen and remove the hardware that attaches the Fender to the Main Frame. Set the hardware safely aside for reassembly.

NOTICE: Hold the Fender so that it does not fall.

7. Loosen the Resistance Knob to the minimum resistance setting.



8. Using a #2 Phillips screwdriver, remove the hardware (indicated by ovals) that secures the Resistance Sensor. Allow the Resistance Sensor to hang from the Cable.

NOTICE: Do not crimp the cable.

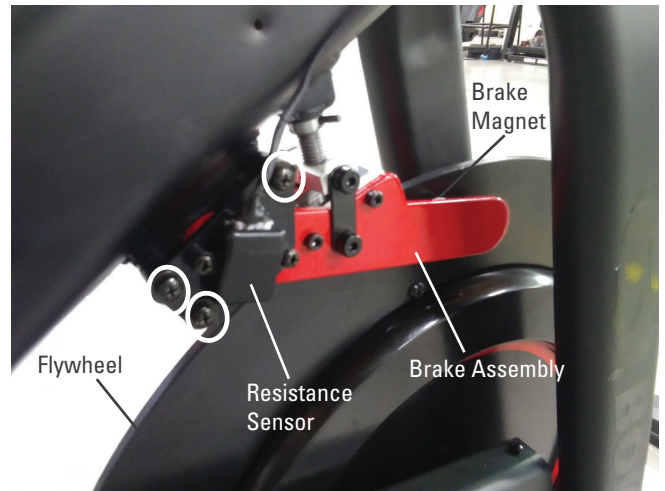

9. Remove the Resistance Sensor Magnet after noting the flat segments are oriented up and downward. This will assist with re-assembly.



10. Using a 10mm open end wrench and a 5mm hex wrench, remove the hardware (indicated by arrows) from both sides of the machine.



11. Using a 3.5mm hex wrench, remove the hardware (indicated by ovals) that attaches the Brake Assembly to the Resistance Nut from both sides of the machine. Carefully remove the Brake Assembly.

NOTICE: Be prepared to support the Brake Assembly.

12. Using a #2 Phillips screwdriver, remove the indicated hardware from the Drive Belt Cover. Carefully remove the Drive Belt Cover and set it safely aside for reassembly.

Note: The oval indicates the two machine screws with washers.



Note: Please disregard the Right Crank Arm in the above image. It was removed during an earlier step.

13. Mark the position of the Flywheel Axle Nut on the Flywheel Bracket. Also record the number of threads showing on the Tensioner Eyebolt on each side of the Tensioner Support Bracket.

14. To loosen the Flywheel hardware, use a 15mm crescent wrench to hold the Flywheel Axle Nut on one side steady and loosen the Flywheel Axle Nut on the opposite side with a 15mm socket and wrench. Remove the Flywheel Axle Nuts from the Flywheel Axle. Set the hardware safely aside for reassembly.



15. Using a 10mm wrench, loosen and remove the outer Flywheel Retainer Nut from the Tensioner Eyebolt. Remove the Tensioner Eyebolt and inner Retaining Nut from the Flywheel Axle and Tensioner Support Bracket. Set the Tensioner hardware aside for reassembly.

NOTICE: It may be necessary to move the Flywheel. This step may require two people.

16. Carefully move the Flywheel Assembly to the opening in the Flywheel Brackets.

NOTICE: This step may require two people.

17. Carefully remove the right end of the Flywheel Axle from the Flywheel Bracket.

NOTICE: Make sure to avoid damage to the Speed Sensor on the left end of the Flywheel Axle.



18. Remove the old Drive Belt from the Flywheel Pulley and Drive Pulley to the outside. Set the old Drive Belt safely aside.

 **Be sure to keep fingers clear of all pinch hazards as you turn the Drive Pulley and Flywheel.**

19. Hold the Flywheel Assembly near the Flywheel Bracket and put the new Drive Belt in position on the Flywheel Pulley.

NOTICE: This step may require two people.

20. Align the Flywheel Axle in the Flywheel Brackets. Hand tighten the hardware from steps 13 and 14 on each end of the Flywheel Axle.

NOTICE: Do not crimp any cables.

21. Put the Drive Belt around the edge of the Drive Pulley. Slowly turn the Drive Pulley and carefully walk the Drive Belt onto the Drive Pulley. Make sure the Drive Belt is aligned on the Flywheel Pulley and Drive Pulley.

 **Be sure to keep fingers clear of all pinch hazards as you turn the Drive Pulley and Flywheel.**

22. Reassembly of the brake parts is the reverse procedure for removal.

NOTICE: Do not crimp any cables. Install the Flywheel Tensioners at the position that you recorded in step 11. Make sure the Flywheel can turn easily. Verify that the Speed Sensor and Speed Sensor Magnet on the Flywheel do not touch.

Installation of the Crank Arms does not require the use of the Crank Puller. Be sure the Crank Arms are connected at 180° from each other.

23. Make sure that the Drive Belt tension is correct. Refer to the “Adjust the Belt Tension” procedure.

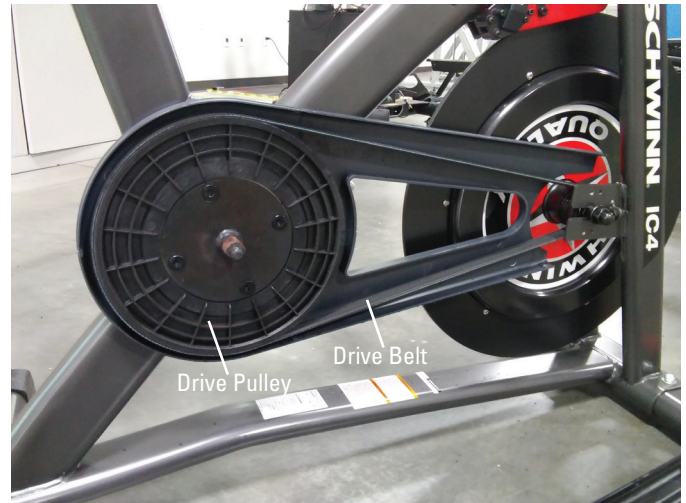

24. Add Loctite® 272 (or equivalent) to the inner threads of the Crank Nut. Do not to apply the Loctite® 272 to the Crank Shaft.

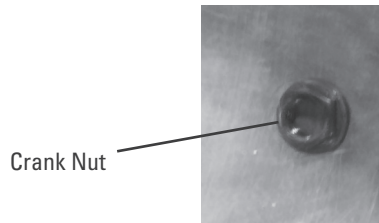

25. Install the Crank Nut onto the Crank Shaft, and fully tighten it.

26. Replace the threaded Cap onto the Crank Arm.

27. Final Inspection

Inspect your machine to ensure that all hardware is tight and components are properly assembled.



Do not use until the machine has been fully assembled and inspected for correct performance in accordance with the Owner's Manual.

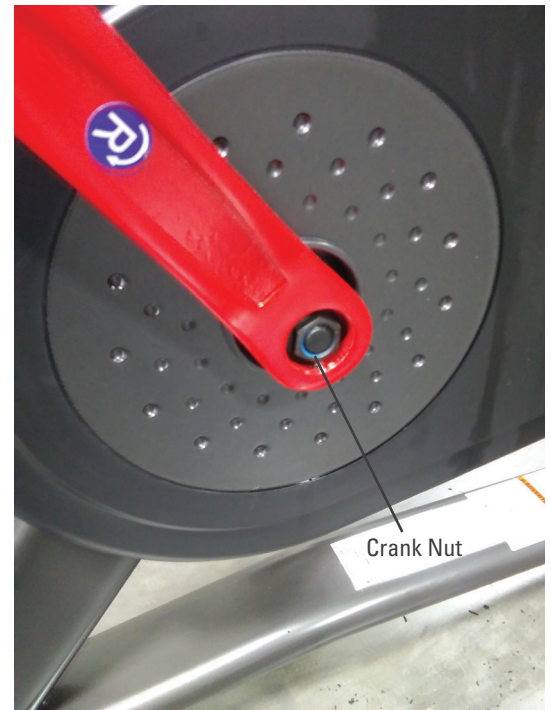

NOTICE: This document provides instructions for the replacement of the Drive Belt Cover on the Schwinn™ IC4 / IC8 / 800IC and Bowflex™ C6 Bikes.

If you need assistance, please call Nautilus Customer Service (if purchased in US/Canada) or your local distributor (if purchased outside US/Canada). To find your local distributor, go to: www.nautilusinternational.com

This icon means a potentially hazardous situation which, if not avoided, could result in death or serious injury. Read and understand all Warnings on this machine.

Nautilus, Inc., www.NautilusInc.com, 5415 Centerpoint Parkway, Groveport, OH 43125 U.S.A. - Customer Service: North America (800) 605-3369, csnls@nautilus.com | outside U.S. www.nautilusinternational.com | Printed in China | © 2020 Nautilus, Inc. | Nautilus, the Nautilus logo, Bowflex and Schwinn are trademarks owned by or licensed to Nautilus, Inc., which are registered or otherwise protected by common law in the United States and other countries. | ORIGINAL DOCUMENT - ENGLISH VERSION ONLY

Important Safety Instructions - Before servicing or using this equipment, obey the following warnings:

This icon means a potentially hazardous situation which, if not avoided, could result in death or serious injury. Read and understand all Warnings on this machine.

- Read and understand the Part Replacement Procedure before working on the machine. Failure to obey the instructions and safety warnings could cause injury to the service technician or bystanders.
- Keep bystanders and children away from the product being serviced at all times.
- Disconnect all power to the machine before you service it.
- Make sure that the repair is done in an appropriate work space away from foot traffic and exposure to bystanders.
- Some components of the equipment can be heavy or awkward. Enlist the service of a second person when you do maintenance steps involving these components. Do not try to do heavy or awkward steps on your own.
- Use only replacement parts and hardware that are supplied or approved by Nautilus. Failure to use Nautilus-approved replacement parts can adversely affect the safety and functionality of the equipment creating a risk to users and will void the warranty.
- Be sure that all warning stickers and instructional placards applied to the product stay present and in good condition when doing maintenance or replacing components. If at any time the Warning labels become loose, unreadable or dislodged, replace the labels. If purchased in US/Canada, contact Customer Service for replacement labels. If purchased outside US/Canada, contact your local distributor for them.
- Do not try to change the design or functionality of the machine being serviced as this can adversely affect user safety.
- Do not use the machine until all shrouds, instructions, warning labels and correct functionality have been verified and tested for correct performance.

• SAVE THESE INSTRUCTIONS

Tools Required (not included)

#2 Phillips screwdriver



15mm Wrench

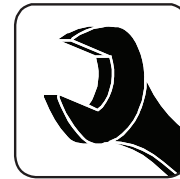

Flathead screwdriver



16mm Socket and Wrench



25mm Crank puller

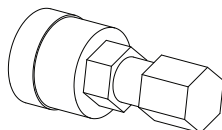

Note: Your machine may not match the image. For reference only.

1. Unplug the AC Adapter from the wall outlet and machine.
2. Fully turn the Resistance Knob clockwise to lock the Flywheel into place.
3. Using a flathead screwdriver, remove the threaded Cap from the Right Crank Arm.



Note: Pedal not shown.

4. Using a 16mm socket and wrench, remove the Flange Nut under the threaded Cap.

5. Thread the Crank Puller into the Crank Arm (A). When the Crank Puller is in the correct position, only 1-2 threads on the outer portion (CP2) of the Crank Puller should show.

Note: Be sure the end of the Bolt (CP1) in the Crank Puller is flush with the inner surface (CP2) as shown, before use.

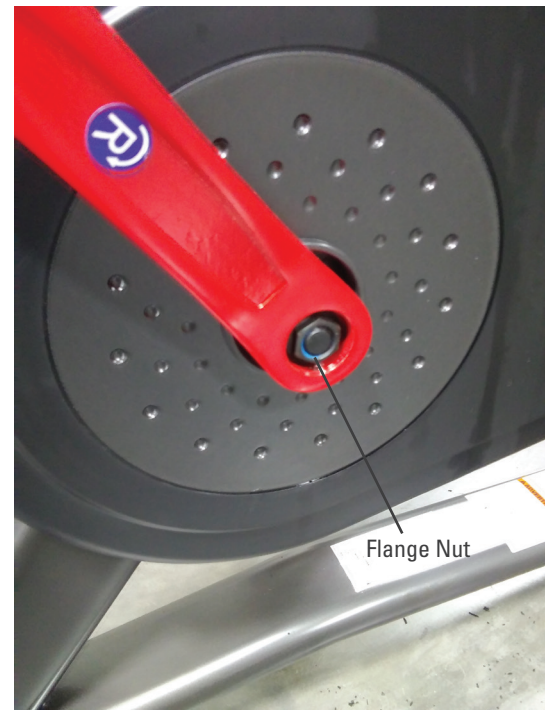
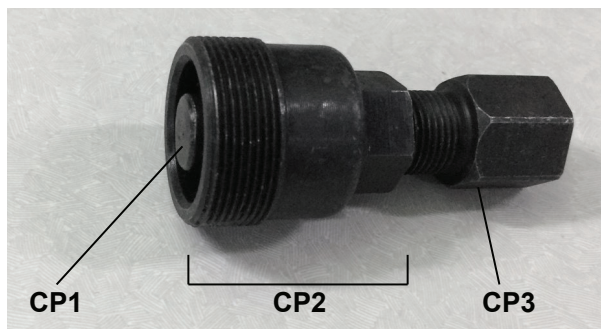

6. Using a 15mm wrench, turn the inner portion (CP3) of the Crank Puller clockwise. The Crank Arm will slide off as it is tightened.

7. Using a #2 Phillips screwdriver, remove the indicated hardware from the Drive Belt Cover.

Note: The oval indicates the two machine screws with washers.

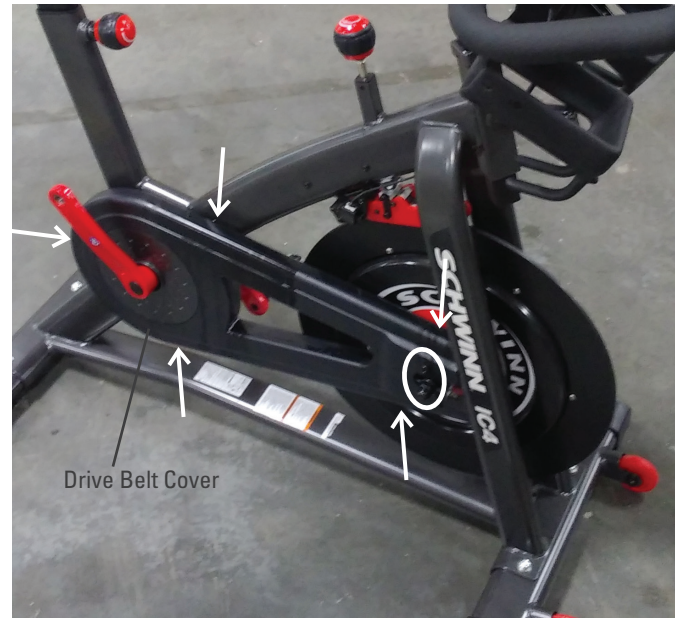

Note: Please disregard the Right Crank Arm in the above image. It was removed during an earlier step.

8. Using a #2 Phillips screwdriver, attach the new Drive Belt Cover to the Frame Assembly.

9. Re-install all remaining parts that were removed in reverse order.

NOTICE: Installation of the Crank Arms does not require the use of the Crank Puller. Be sure the Crank Arms are connected at 180° from each other.



10. Final Inspection

Inspect your machine to ensure that all hardware is tight and components are properly assembled.



Do not use until the machine has been fully assembled and inspected for correct performance in accordance with the Owner's Manual.

NOTICE: This document provides instructions for the replacement of the Drive (Crank) Pulley on the Schwinn™ IC4 / IC8 / 800IC and Bowflex™ C6 Bikes.

If you need assistance, please call Nautilus Customer Service (if purchased in US/Canada) or your local distributor (if purchased outside US/Canada). To find your local distributor, go to: www.nautilusinternational.com

⚠ This icon means a potentially hazardous situation which, if not avoided, could result in death or serious injury. Read and understand all Warnings on this machine.

Nautilus, Inc., www.NautilusInc.com, 5415 Centerpoint Parkway, Groveport, OH 43125 U.S.A. - Customer Service: North America (800) 605-3369, csnls@nautilus.com | outside U.S. www.nautilusinternational.com | Printed in China | © 2021 Nautilus, Inc. | Nautilus, the Nautilus logo, Bowflex and Schwinn are trademarks owned by or licensed to Nautilus, Inc., which are registered or otherwise protected by common law in the United States and other countries. | ORIGINAL DOCUMENT - ENGLISH VERSION ONLY

Important Safety Instructions - Before servicing or using this equipment, obey the following warnings:

⚠ This icon means a potentially hazardous situation which, if not avoided, could result in death or serious injury. Read and understand all Warnings on this machine.

- Read and understand the Part Replacement Procedure before working on the machine. Failure to obey the instructions and safety warnings could cause injury to the service technician or bystanders.
- Keep bystanders and children away from the product being serviced at all times.
- Disconnect all power to the machine before you service it.
- Make sure that the repair is done in an appropriate work space away from foot traffic and exposure to bystanders.
- Some components of the equipment can be heavy or awkward. Enlist the service of a second person when you do maintenance steps involving these components. Do not try to do heavy or awkward steps on your own.
- Use only replacement parts and hardware that are supplied or approved by Nautilus. Failure to use Nautilus-approved replacement parts can adversely affect the safety and functionality of the equipment creating a risk to users and will void the warranty.
- Be sure that all warning stickers and instructional placards applied to the product stay present and in good condition when doing maintenance or replacing components. If at any time the Warning labels become loose, unreadable or dislodged, replace the labels. If purchased in US/Canada, contact Customer Service for replacement labels. If purchased outside US/Canada, contact your local distributor for them.
- Do not try to change the design or functionality of the machine being serviced as this can adversely affect user safety.
- Do not use the machine until all shrouds, instructions, warning labels and correct functionality have been verified and tested for correct performance.

• SAVE THESE INSTRUCTIONS

Tools Required (not included)

#2 Phillips screwdriver



15mm Wrench
10mm Wrench



Flathead screwdriver

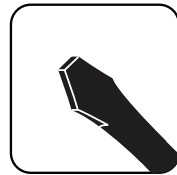

16mm Socket and Wrench



25mm Crank puller

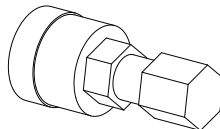

Rubber Mallet

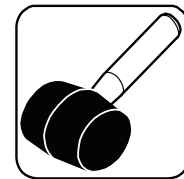

External Snap Ring Pliers

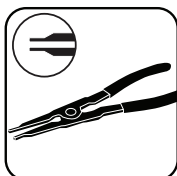

Red Loctite® 272 or equivalent
(high strength)



Eye protection

Tape or marking pen



NOTICE: At the end of this procedure, make sure that the Drive Belt tension is correct. Refer to the “Adjust the Belt Tension” procedure.

Note: Your machine may not match the image. For reference only.

1. Unplug the AC Adapter from the wall outlet and machine.

 **Keep the flywheel stable during this procedure. Do not turn the crank arms. Flywheel movement can pull fingers in and cause injury.**

2. Using a flathead screwdriver, remove the threaded Cap from the Right Crank Arm.



3. Using a 16mm socket and wrench, remove the Crank Nut under the threaded Cap.

4. Thread the Crank Puller into the Crank Arm (A). When the Crank Puller is in the correct position, only 1-2 threads on the outer portion (CP2) of the Crank Puller should show.

Note: Be sure the end of the Bolt (CP1) in the Crank Puller is flush with the inner surface (CP2) as shown, before use.

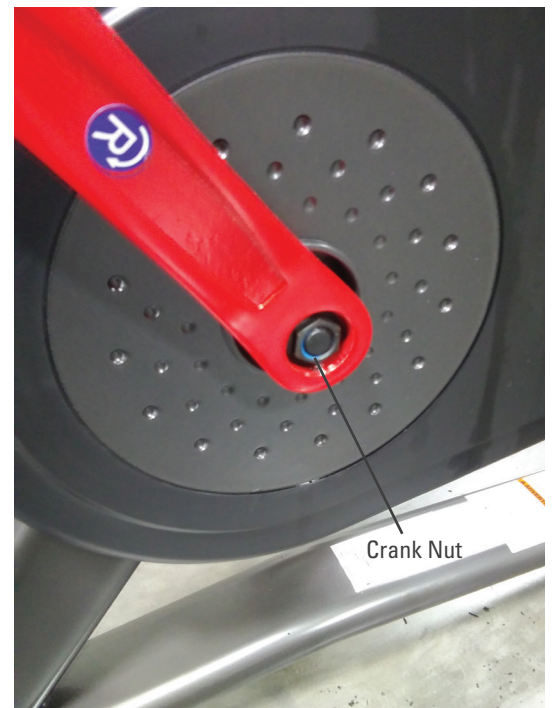
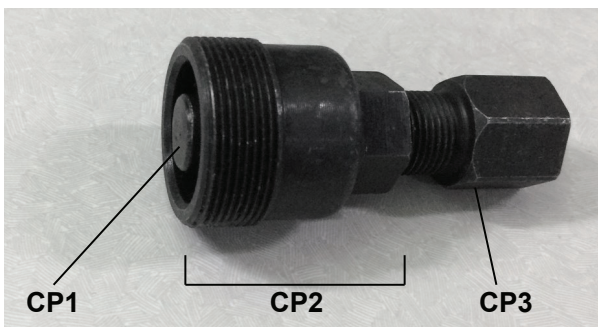

5. Repeat the last three steps on the left side of the bike.

6. Using a #2 Phillips screwdriver, remove the indicated hardware from the Drive Belt Cover. Carefully remove the Drive Belt Cover and set it safely aside for reassembly.

Note: The oval indicates the two machine screws with washers.

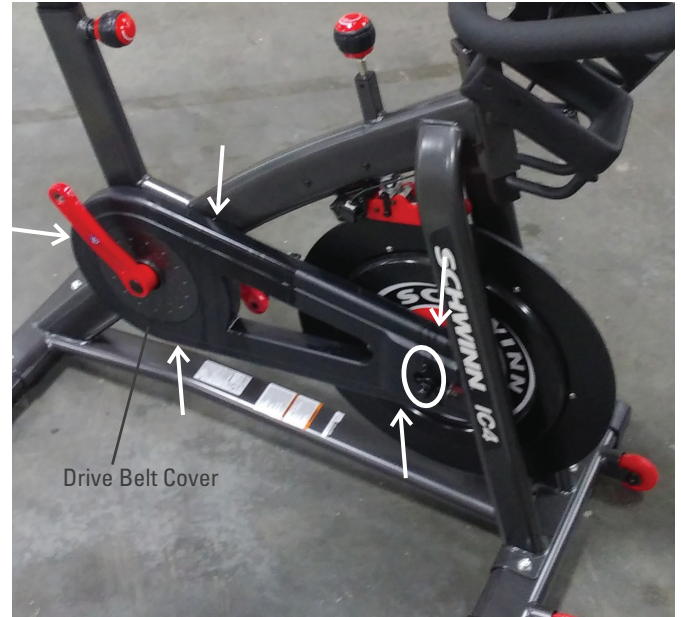

Note: Please disregard the Right Crank Arm in the above image. It was removed during an earlier step.

7. Record the number of threads showing on the Tensioner Eyebolt on each side of the Tensioner Support Bracket.

8. Using a 10mm wrench, loosen the outer Flywheel Retainer Nut on both sides of the machine. Loosen the outer Flywheel Retainer Nut until there is a visible slack in the Drive Belt. This will ease the removal of the Drive Belt from the Drive (Crank) Pulley.



9. To remove the Drive Belt from the Drive Pulley, slightly pull the Drive Belt outward while safely rolling the Drive Pulley. The Drive Belt will come off of the Drive Pulley. Set the Drive Belt safely aside.



Be sure to keep fingers clear of all pinch hazards as you turn the Drive Pulley.

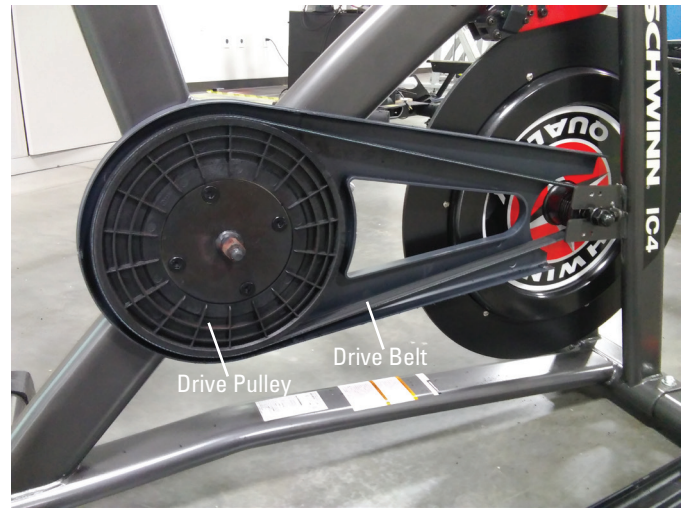

10. Remove the Left Crank Cover from the left side of the bike.

11. Using eye protection and snap ring removal tool, remove the Snap Ring from the Pulley Shaft Assembly on the left side.

12. Using eye protection and a rubber mallet (or wooden block and hammer), gently strike the Pulley Shaft Assembly from the left side of the bike until it works out of the Frame and releases the Drive Pulley with crankshaft and Wave Washer. The bearings will stay in the frame.

13. Remove the Wave Washer from the old Drive Pulley, and place it onto the new Drive Pulley in the same location.

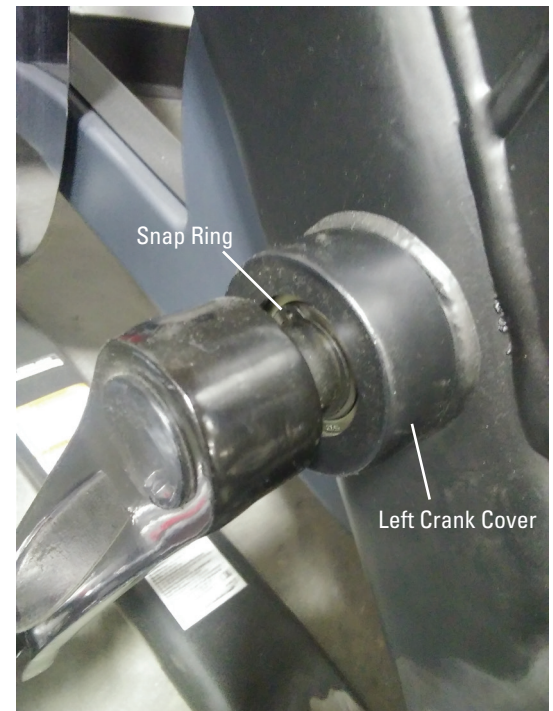

Note: Please disregard the Left Crank Arm in the above image. It was removed during an earlier step.

14. Reassembly of the Drive Pulley procedure is the reverse of the removal.

NOTICE: Put the Drive Belt around the edge of the Drive Pulley. Slowly turn the Drive Pulley and carefully walk the Drive Belt onto the Drive Pulley. Make sure the Drive Belt is aligned on the Flywheel Pulley and Drive Pulley.



Be sure to keep fingers clear of all pinch hazards as you turn the Drive Pulley and Flywheel.

Installation of the Crank Arms does not require the use of the Crank Puller. Be sure the Crank Arms are connected at 180° from each other.

15. Make sure that the Drive Belt tension is correct. Refer to the “Adjust the Belt Tension” procedure.

16. Add Loctite® 272 (or equivalent) to the inner threads of the Crank Nut. Do not to apply the Loctite® 272 to the Crank Shaft.

Crank Nut

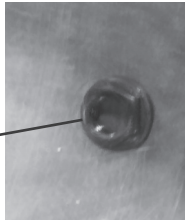

17. Install the Crank Nut onto the Crank Shaft, and fully tighten it.

18. Replace the threaded Cap onto the Crank Arm.

19. Final Inspection

Inspect your machine to ensure that all hardware is tight and components are properly assembled.



Do not use until the machine has been fully assembled and inspected for correct performance in accordance with the Owner's Manual.

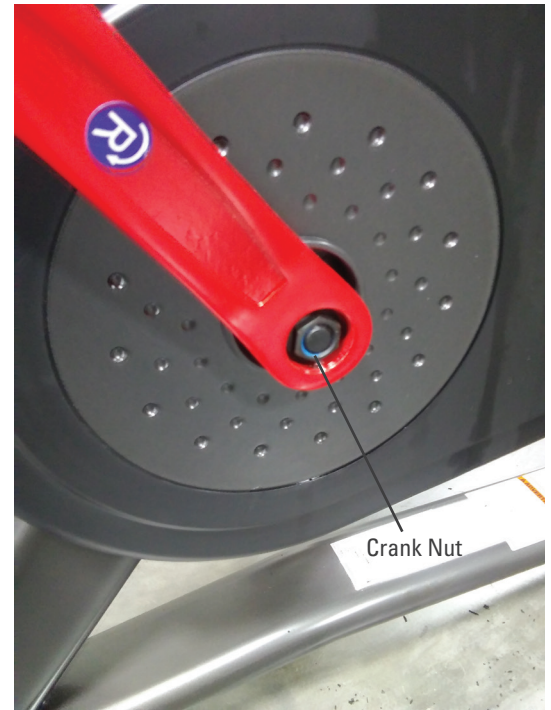

NOTICE: This document provides instructions for the replacement of the Fender on the Schwinn™ IC4 / IC8 / 800IC and Bowflex™ C6 Bikes.

If you need assistance, please call Nautilus Customer Service (if purchased in US/Canada) or your local distributor (if purchased outside US/Canada). To find your local distributor, go to: www.nautilusinternational.com

 **This icon means a potentially hazardous situation which, if not avoided, could result in death or serious injury. Read and understand all Warnings on this machine.**

Nautilus, Inc., www.NautilusInc.com, 5415 Centerpoint Parkway, Groveport, OH 43125 U.S.A. - Customer Service: North America (800) 605-3369, csnls@nautilus.com | outside U.S. www.nautilusinternational.com | Printed in China | © 2019 Nautilus, Inc. | Nautilus, the Nautilus logo, Bowflex and Schwinn are trademarks owned by or licensed to Nautilus, Inc., which are registered or otherwise protected by common law in the United States and other countries. | ORIGINAL DOCUMENT - ENGLISH VERSION ONLY

Important Safety Instructions - Before servicing or using this equipment, obey the following warnings:

 **This icon means a potentially hazardous situation which, if not avoided, could result in death or serious injury. Read and understand all Warnings on this machine.**

- Read and understand the Part Replacement Procedure before working on the machine. Failure to obey the instructions and safety warnings could cause injury to the service technician or bystanders.
- Keep bystanders and children away from the product being serviced at all times.
- Disconnect all power to the machine before you service it.
- Make sure that the repair is done in an appropriate work space away from foot traffic and exposure to bystanders.
- Some components of the equipment can be heavy or awkward. Enlist the service of a second person when you do maintenance steps involving these components. Do not try to do heavy or awkward steps on your own.
- Use only replacement parts and hardware that are supplied or approved by Nautilus. Failure to use Nautilus-approved replacement parts can adversely affect the safety and functionality of the equipment creating a risk to users and will void the warranty.
- Be sure that all warning stickers and instructional placards applied to the product stay present and in good condition when doing maintenance or replacing components. If at any time the Warning labels become loose, unreadable or dislodged, replace the labels. If purchased in US/Canada, contact Customer Service for replacement labels. If purchased outside US/Canada, contact your local distributor for them.
- Do not try to change the design or functionality of the machine being serviced as this can adversely affect user safety.
- Do not use the machine until all shrouds, instructions, warning labels and correct functionality have been verified and tested for correct performance.

• SAVE THESE INSTRUCTIONS

Tools Required (not included)

#2 Phillips screwdriver

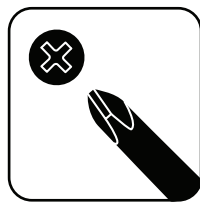

Note: Your machine may not match the images provided exactly.

1. Unplug the AC Adapter from the wall outlet and machine.

2. Loosen and remove the hardware (indicated by ovals on this side of the machine) that attaches the Fender to the Main Frame. Set the hardware safely aside for re-assembly.

NOTICE: Hold the Fender so that it does not fall.

3. Remove the Fender from the front of the machine after noting how the Resistance Cable routes through it.

NOTICE: Do not crimp the cable.



4. Install the new Fender, making sure the Resistance Cable is routed between the Frame and the top of the Fender.

5. Final Inspection

Inspect your machine to ensure that all hardware is tight and components are properly assembled.



Do not use until the machine has been fully assembled and inspected for correct performance in accordance with the Owner's Manual.



NOTICE: This document provides instructions for the replacement of the Flywheel Assembly on the Schwinn™ IC4 / IC8 / 800IC and Bowflex™ C6 Bikes.

If you need assistance, please call Nautilus Customer Service (if purchased in US/Canada) or your local distributor (if purchased outside US/Canada). To find your local distributor, go to: www.nautilusinternational.com

⚠ This icon means a potentially hazardous situation which, if not avoided, could result in death or serious injury. Read and understand all Warnings on this machine.

Nautilus, Inc., www.NautilusInc.com, 5415 Centerpoint Parkway, Groveport, OH 43125 U.S.A. - Customer Service: North America (800) 605-3369, csnls@nautilus.com | outside U.S. www.nautilusinternational.com | Printed in China | © 2019 Nautilus, Inc. | Nautilus, the Nautilus logo, Bowflex and Schwinn are trademarks owned by or licensed to Nautilus, Inc., which are registered or otherwise protected by common law in the United States and other countries. | ORIGINAL DOCUMENT - ENGLISH VERSION ONLY

Important Safety Instructions - Before servicing or using this equipment, obey the following warnings:

⚠ This icon means a potentially hazardous situation which, if not avoided, could result in death or serious injury. Read and understand all Warnings on this machine.

- Read and understand the Part Replacement Procedure before working on the machine. Failure to obey the instructions and safety warnings could cause injury to the service technician or bystanders.
- Keep bystanders and children away from the product being serviced at all times.
- Disconnect all power to the machine before you service it.
- Make sure that the repair is done in an appropriate work space away from foot traffic and exposure to bystanders.
- Some components of the equipment can be heavy or awkward. Enlist the service of a second person when you do maintenance steps involving these components. Do not try to do heavy or awkward steps on your own.
- Use only replacement parts and hardware that are supplied or approved by Nautilus. Failure to use Nautilus-approved replacement parts can adversely affect the safety and functionality of the equipment creating a risk to users and will void the warranty.
- Be sure that all warning stickers and instructional placards applied to the product stay present and in good condition when doing maintenance or replacing components. If at any time the Warning labels become loose, unreadable or dislodged, replace the labels. If purchased in US/Canada, contact Customer Service for replacement labels. If purchased outside US/Canada, contact your local distributor for them.
- Do not try to change the design or functionality of the machine being serviced as this can adversely affect user safety.
- Do not use the machine until all shrouds, instructions, warning labels and correct functionality have been verified and tested for correct performance.

• SAVE THESE INSTRUCTIONS

Tools Required (not included)

#2 Phillips screwdriver



15mm Wrench
10mm Wrench



Small flathead screwdriver

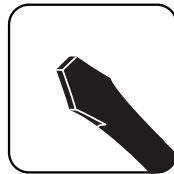

16mm Socket and Wrench
15mm Socket and Wrench



25mm Crank puller

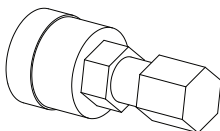

3.5mm Hex wrench
5mm Hex wrench

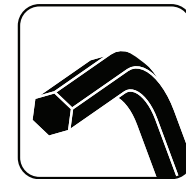

Red Loctite® 272 or equivalent
(high strength)



Tape or marking pen



NOTICE: At the end of this procedure, make sure that the Drive Belt tension is correct. Refer to the “Adjust the Belt Tension” procedure.

Note: Your machine may not match the images provided exactly.

1. Unplug the AC Adapter from the wall outlet and machine.
2. Fully turn the Resistance Knob clockwise to lock the Flywheel into place.
3. Using a flathead screwdriver, remove the threaded Cap from the right Crank Arm.



4. Using a 16mm socket and wrench, remove the Crank Nut under the threaded Cap.

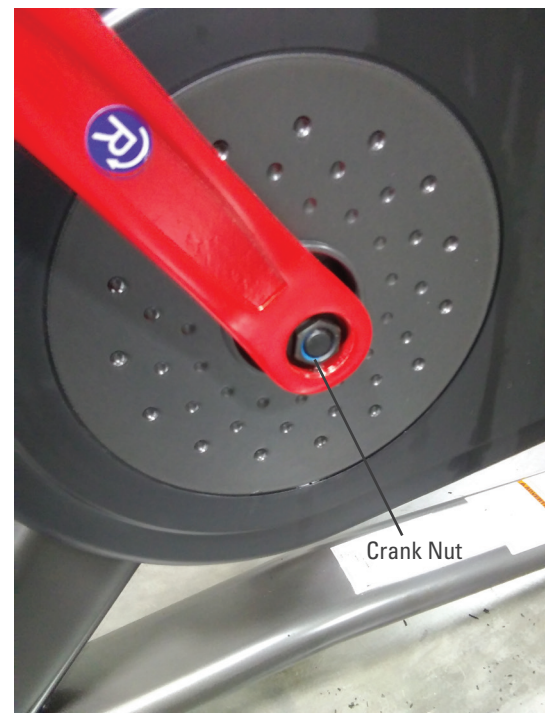

5. Thread the Crank Puller into the Crank Arm (A). When the Crank Puller is in the correct position, only 1-2 threads on the outer portion (CP2) of the Crank Puller should show.

Note: Be sure the end of the Bolt (CP1) in the Crank Puller is flush with the inner surface (CP2) as shown, before use.

6. Using a 15mm wrench, turn the inner portion (CP3) of the Crank Puller clockwise. The Crank Arm will slide off as it is tightened.

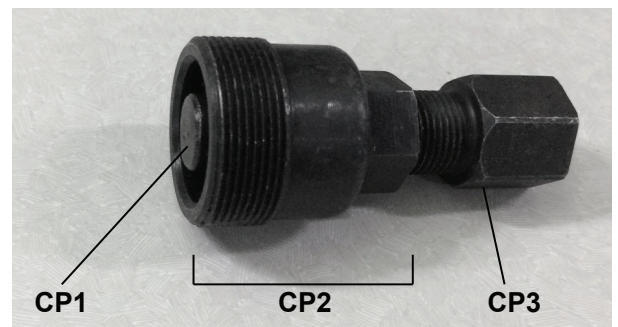

7. Using a #2 Phillips screwdriver, loosen and remove the hardware (indicated on one side by ovals) that attaches the Fender to the Main Frame. Set the hardware safely aside for reassembly.

NOTICE: Hold the Fender so that it does not fall.

8. Remove the Fender from the front of the machine after noting how the Resistance Cable routes through it. Place the Fender outside the work area.

9. Loosen the Resistance Knob to the minimum resistance setting.



10. Using a #2 Phillips screwdriver, remove the hardware (indicated by ovals) that secures the Resistance Sensor. Allow the Resistance Sensor to hang from the Cable.

NOTICE: Do not crimp the cable.

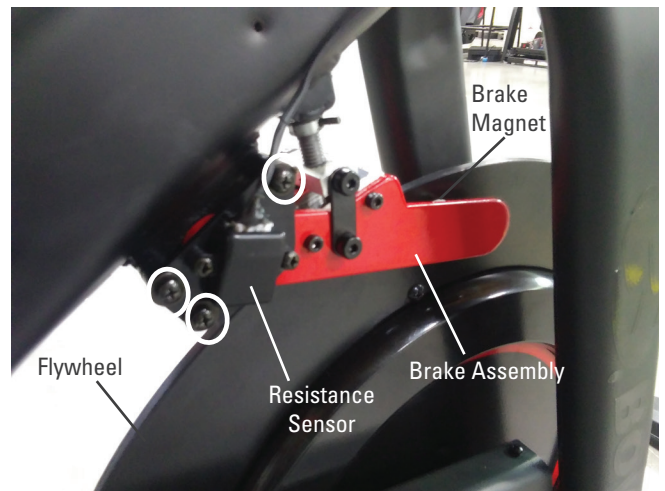

11. Remove the Resistance Sensor Magnet after noting the flat segments are oriented up and downward. This will assist with re-assembly.



12. Using a 10mm open end wrench and a 5mm hex wrench, remove the hardware (indicated by arrows) from both sides of the machine.



13. Using a 3.5mm hex wrench, remove the hardware (indicated by ovals) that attaches the Brake Assembly to the Resistance Nut from both sides of the machine. Carefully remove the Brake Assembly.

NOTICE: Be prepared to support the Brake Assembly.

14. Using a #2 Phillips screwdriver, remove the indicated hardware from the Drive Belt Cover. Carefully remove the Drive Belt Cover and set it safely aside for reassembly.

Note: The oval indicates the two machine screws with washers.



Note: Please disregard the Right Crank Arm in the above image. It was removed during an earlier step.

15. Mark the position of the Flywheel Axle Nut on the Flywheel Bracket. Also record the number of threads showing on the Tensioner Eyebolt on each side of the Tensioner Support Bracket.

16. To loosen the Flywheel hardware, use a 15mm crescent wrench to hold the Flywheel Axle Nut on one side steady and loosen the Flywheel Axle Nut on the opposite side with a 15mm socket and wrench. Remove the Flywheel Axle Nuts from the Flywheel Axle. Set the hardware safely aside for reassembly.



17. Using a 10mm wrench, loosen and remove the outer Flywheel Retainer Nut from the Tensioner Eyebolt. Remove the Tensioner Eyebolt and inner Retaining Nut from the Flywheel Axle and Tensioner Support Bracket. Set the Tensioner hardware aside for reassembly.

NOTICE: It may be necessary to move the Flywheel. This step may require two people.

18. Carefully move the Flywheel to the opening in the Flywheel Brackets, and then remove the Flywheel from the Flywheel Bracket. Remove the Thin Nut from the left end of the Axle and set it safely aside for reassembly.

NOTICE: This step may require two people.

19. Carefully remove the Speed Sensor and Spacer from the Axle. Set the old Speed Sensor safely aside.

NOTICE: This step may require two people.



20. Remove the Drive Belt from the Flywheel Pulley to the outside. Remove the Thin Nut from the right end of the Axle and set it safely aside for reassembly.

NOTICE: This step may require two people.

21. Remove the old Flywheel Assembly and set it safely aside.



Be sure to keep fingers clear of all pinch hazards.

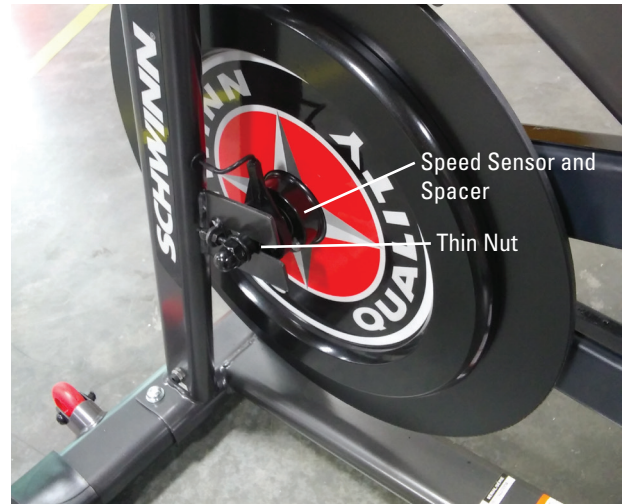

22. Hold the new Flywheel Assembly near the Flywheel Brackets and put the Speed Sensor and Spacer on the Axle. Reinstall the Thin Nuts on each end of the Axle. Put the Drive Belt in position on the Flywheel Pulley.

NOTICE: This step may require two people. Do not crimp any cables.

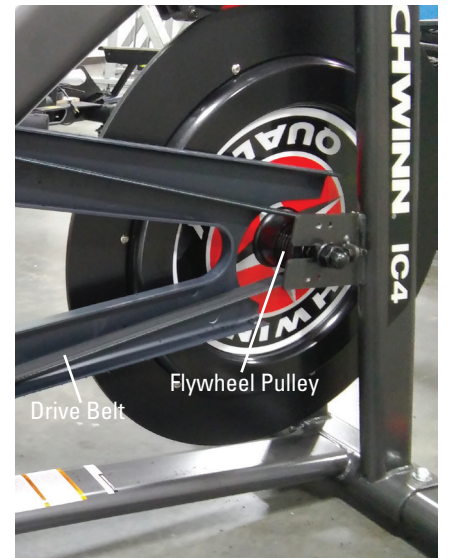

23. Align the Flywheel Axle in the Flywheel Brackets. Hand tighten the hardware from steps 13 and 14 on each end of the Flywheel Axle.

NOTICE: Do not crimp any cables.

24. Put the Drive Belt around the edge of the Drive Pulley. Slowly turn the Drive Pulley and carefully walk the Drive Belt onto the Drive Pulley. Make sure the Drive Belt is aligned on the Flywheel Pulley and Drive Pulley.



Be sure to keep fingers clear of all pinch hazards as you turn the Drive Pulley and Flywheel.

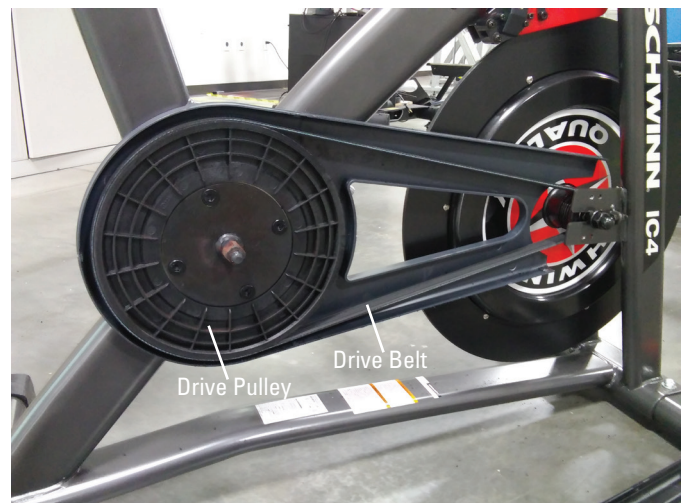

25. Re-install all remaining parts that were removed in reverse order.

NOTICE: Do not crimp any cables. Install the Flywheel Tensioners at the position that you recorded in step 15. Make sure the Flywheel can turn easily. Verify that the Speed Sensor and Speed Sensor Magnet on the Flywheel do not touch.



Re-install the Fender, making sure the Resistance Cable is routed between the Frame and the top of the Fender.

Installation does not require the use of the Crank Puller. Be sure the Crank Arms are connected at 180° from each other.

26. Make sure that the Drive Belt tension is correct. Refer to the "Adjust the Belt Tension" procedure.



27. Add Loctite® 272 (or equivalent) to the inner threads of the Crank Nut. Do not apply the Loctite® 272 to the Crank Shaft.

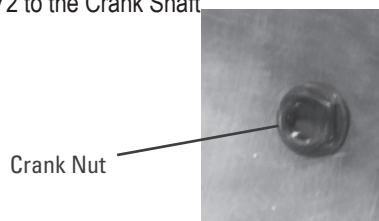

28. Install the Crank Nut onto the Crank Shaft, and fully tighten it.

29. Replace the threaded Cap onto the Crank Arm.

30. Final Inspection

Inspect your machine to ensure that all hardware is tight and components are properly assembled.



Do not use until the machine has been fully assembled and inspected for correct performance in accordance with the Owner's Manual.

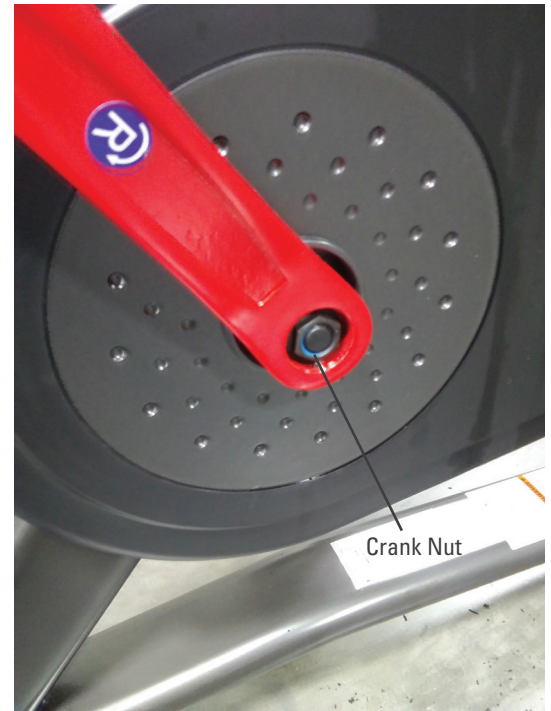

NOTICE: This document provides instructions for the replacement of the Flywheel Tensioners on the Schwinn™ IC4 / IC8 / 800IC and Bowflex™ C6 Bikes.

If you need assistance, please call Nautilus Customer Service (if purchased in US/Canada) or your local distributor (if purchased outside US/Canada). To find your local distributor, go to: www.nautilusinternational.com

⚠ This icon means a potentially hazardous situation which, if not avoided, could result in death or serious injury. Read and understand all Warnings on this machine.

Nautilus, Inc., www.NautilusInc.com, 5415 Centerpoint Parkway, Groveport, OH 43125 U.S.A. - Customer Service: North America (800) 605-3369, csnls@nautilus.com | outside U.S. www.nautilusinternational.com | Printed in China | © 2020 Nautilus, Inc. | Nautilus, the Nautilus logo, Bowflex and Schwinn are trademarks owned by or licensed to Nautilus, Inc., which are registered or otherwise protected by common law in the United States and other countries. | ORIGINAL DOCUMENT - ENGLISH VERSION ONLY

Important Safety Instructions - Before servicing or using this equipment, obey the following warnings:

⚠ This icon means a potentially hazardous situation which, if not avoided, could result in death or serious injury. Read and understand all Warnings on this machine.

- Read and understand the Part Replacement Procedure before working on the machine. Failure to obey the instructions and safety warnings could cause injury to the service technician or bystanders.
- Keep bystanders and children away from the product being serviced at all times.
- Disconnect all power to the machine before you service it.
- Make sure that the repair is done in an appropriate work space away from foot traffic and exposure to bystanders.
- Some components of the equipment can be heavy or awkward. Enlist the service of a second person when you do maintenance steps involving these components. Do not try to do heavy or awkward steps on your own.
- Use only replacement parts and hardware that are supplied or approved by Nautilus. Failure to use Nautilus-approved replacement parts can adversely affect the safety and functionality of the equipment creating a risk to users and will void the warranty.
- Be sure that all warning stickers and instructional placards applied to the product stay present and in good condition when doing maintenance or replacing components. If at any time the Warning labels become loose, unreadable or dislodged, replace the labels. If purchased in US/Canada, contact Customer Service for replacement labels. If purchased outside US/Canada, contact your local distributor for them.
- Do not try to change the design or functionality of the machine being serviced as this can adversely affect user safety.
- Do not use the machine until all shrouds, instructions, warning labels and correct functionality have been verified and tested for correct performance.

• SAVE THESE INSTRUCTIONS

Tools Required (not included)

#2 Phillips screwdriver

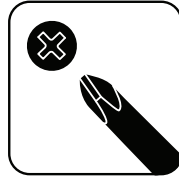

15mm Wrench

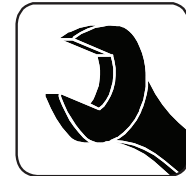

Small flathead screwdriver



15mm Socket and Wrench



25mm Crank puller

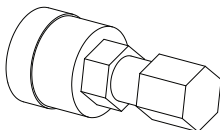

Red Loctite® 272 or equivalent
(high strength)



Tape or marking pen



NOTICE: At the end of this procedure, make sure that the Drive Belt tension is correct. Refer to the “Adjust the Belt Tension” procedure.

Note: Your machine may not match the images provided exactly.

1. Unplug the AC Adapter from the wall outlet and machine.
2. Fully turn the Resistance Knob clockwise to lock the Flywheel into place.
3. Using a flathead screwdriver, remove the threaded Cap from the right Crank Arm.



4. Using a 16mm socket and wrench, remove the Crank Nut under the threaded Cap.

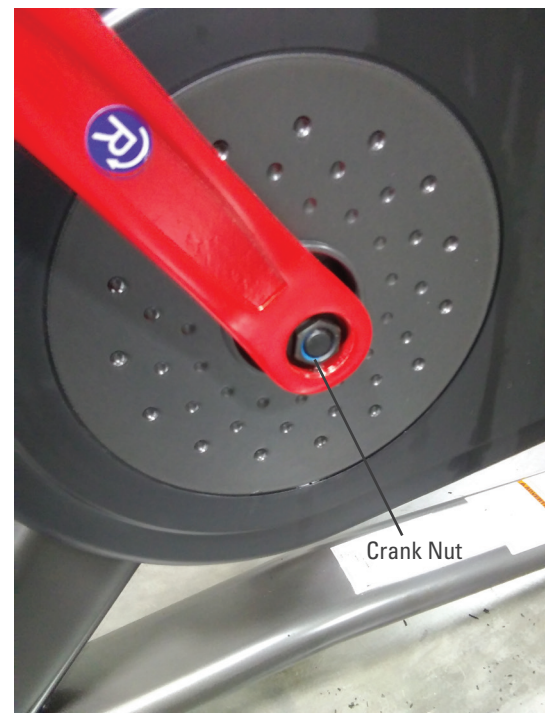

5. Thread the Crank Puller into the Crank Arm (A). When the Crank Puller is in the correct position, only 1-2 threads on the outer portion (CP2) of the Crank Puller should show.

Note: Be sure the end of the Bolt (CP1) in the Crank Puller is flush with the inner surface (CP2) as shown, before use.

6. Using a 15mm wrench, turn the inner portion (CP3) of the Crank Puller clockwise. The Crank Arm will slide off as it is tightened.

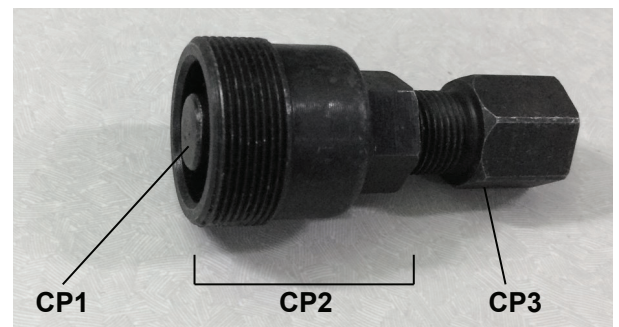

7. Using a #2 Phillips screwdriver, remove the indicated hardware from the Drive Belt Cover. Carefully remove the Drive Belt Cover and set it safely aside for reassembly.

Note: The oval indicates the two machine screws with washers.

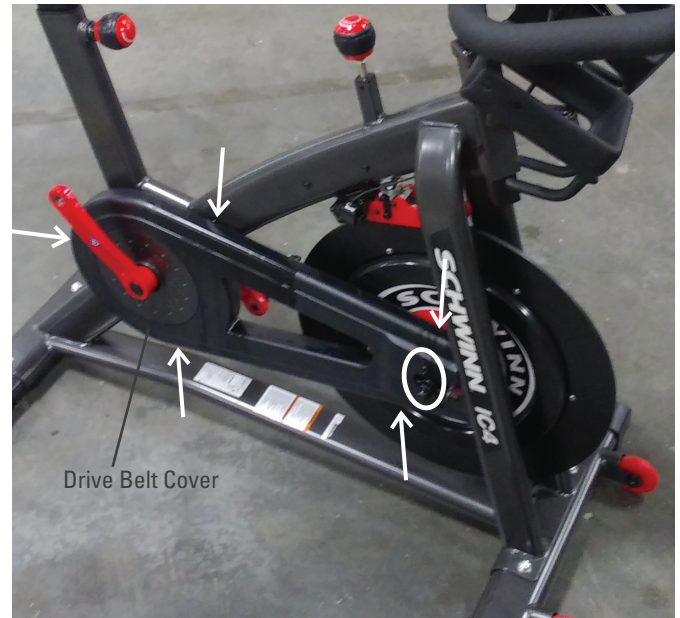

Note: Please disregard the Right Crank Arm in the above image. It was removed during an earlier step.

8. Mark the position of the Flywheel Axle Nut on the Flywheel Bracket. Also record the number of threads showing on the Tensioner Eyebolt, or Flywheel Tensioners, on each side of the Tensioner Support Bracket.

9. To loosen the Flywheel hardware, use a 15mm crescent wrench to hold the Flywheel Axle Nut on one side steady and loosen the Flywheel Axle Nut on the opposite side with a 15mm socket and wrench. Remove the Flywheel Axle Nuts from the Flywheel Axle. Set the hardware safely aside for reassembly.



10. Using a 10mm wrench, loosen and remove the outer Flywheel Retainer Nut from the Tensioner Eyebolt. Remove the Tensioner Eyebolt and Inner Retaining Nut from the Flywheel Axle and Tensioner Support Bracket.

11. Place the inner Retaining Nuts in the same location on the new Tensioner Eyebolts.

12. Place the Tensioner Eyebolts on the Flywheel Axle, and through the Tensioner Support Bracket.

13. Re-install all remaining parts that were removed in reverse order up to the Crank Nut.

NOTICE: Do not crimp any cables. Install the Flywheel Tensioners at the position that you recorded in Step 9. Make sure the Flywheel can turn easily and is centered on the Brake Assembly.

Installation does not require the use of the Crank Puller. Be sure the Crank Arms are connected at 180° from each other.

14. Add Loctite® 272 (or equivalent) to the inner threads of the Crank Nut. Do not to apply the Loctite® 272 to the Crank Shaft.

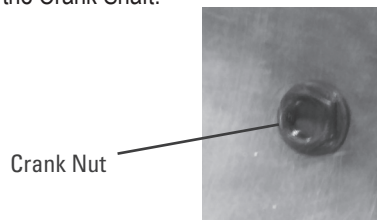

15. Install the Crank Nut onto the Crank Shaft, and fully tighten it.

16. Replace the threaded Cap onto the Crank Arm.

17. Final Inspection

Inspect your machine to ensure that all hardware is tight and components are properly assembled.



Do not use until the machine has been fully assembled and inspected for correct performance in accordance with the Owner's Manual.

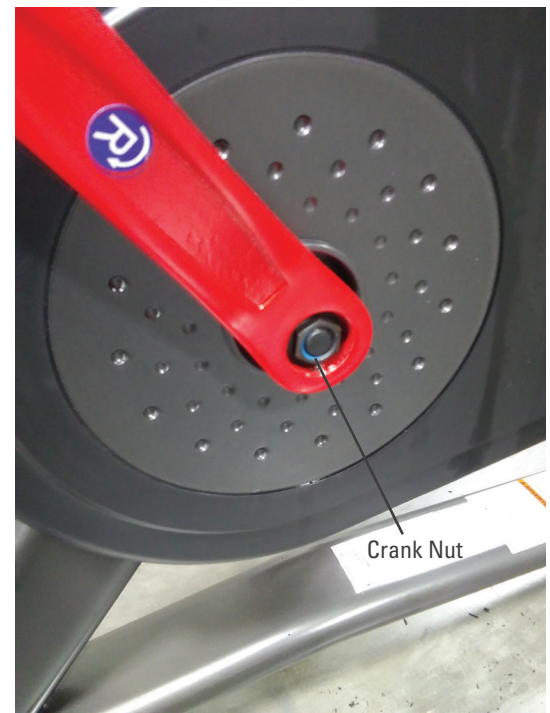

NOTICE: This document provides instructions for the replacement of the Handlebar and Seat Post Bushings on the Schwinn™ IC4 / IC8 / 800IC and Bowflex™ C6 Bikes.

If you need assistance, please call Nautilus Customer Service (if purchased in US/Canada) or your local distributor (if purchased outside US/Canada). To find your local distributor, go to: www.nautilusinternational.com

 **This icon means a potentially hazardous situation which, if not avoided, could result in death or serious injury. Read and understand all Warnings on this machine.**

Nautilus, Inc., www.NautilusInc.com, 5415 Centerpoint Parkway, Groveport, OH 43125 U.S.A. - Customer Service: North America (800) 605-3369, csnls@nautilus.com | outside U.S. www.nautilusinternational.com | Printed in China | © 2020 Nautilus, Inc. | Nautilus, the Nautilus logo, Bowflex and Schwinn are trademarks owned by or licensed to Nautilus, Inc., which are registered or otherwise protected by common law in the United States and other countries. | ORIGINAL DOCUMENT - ENGLISH VERSION ONLY

Important Safety Instructions - Before servicing or using this equipment, obey the following warnings:

 **This icon means a potentially hazardous situation which, if not avoided, could result in death or serious injury. Read and understand all Warnings on this machine.**

- Read and understand the Part Replacement Procedure before working on the machine. Failure to obey the instructions and safety warnings could cause injury to the service technician or bystanders.
- Keep bystanders and children away from the product being serviced at all times.
- Disconnect all power to the machine before you service it.
- Make sure that the repair is done in an appropriate work space away from foot traffic and exposure to bystanders.
- Some components of the equipment can be heavy or awkward. Enlist the service of a second person when you do maintenance steps involving these components. Do not try to do heavy or awkward steps on your own.
- Use only replacement parts and hardware that are supplied or approved by Nautilus. Failure to use Nautilus-approved replacement parts can adversely affect the safety and functionality of the equipment creating a risk to users and will void the warranty.
- Be sure that all warning stickers and instructional placards applied to the product stay present and in good condition when doing maintenance or replacing components. If at any time the Warning labels become loose, unreadable or dislodged, replace the labels. If purchased in US/Canada, contact Customer Service for replacement labels. If purchased outside US/Canada, contact your local distributor for them.
- Do not try to change the design or functionality of the machine being serviced as this can adversely affect user safety.
- Do not use the machine until all shrouds, instructions, warning labels and correct functionality have been verified and tested for correct performance.

• SAVE THESE INSTRUCTIONS

Tools Required (not included)

Small Standard Screwdriver



Heat Gun



 **Be sure to follow any manual or safety instructions supplied from the manufacturer as regards to the proper and safe use of the Heat Gun.**



Note: Your machine may not match the images provided exactly.

1. Unplug the AC Adapter from the wall outlet and machine.
2. Fully turn the Resistance Knob clockwise to lock the Flywheel into place.
3. Remove the Dumbbells from the Handlebars if they are in place on the Dumbbell Rack.
4. If only replacing the Seat Post Bushing, skip to Step 15.



5. Disconnect the Cables that connect the Console to the Frame Assembly.

NOTICE: Do not crimp any cables.

6. Being prepared to support the Handlebars, loosen the Handlebar Post Adjustment Handle and remove the Handlebar Assembly from the Frame Assembly. Set the Handlebar Assembly safely aside away from the work area.

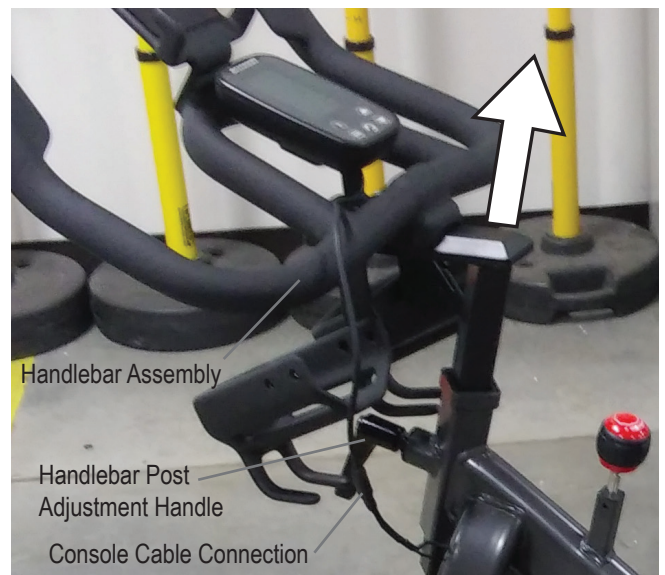

7. Remove the Handlebar Post Adjustment Handle from the Frame Assembly.

8. Using a 32mm Open Faced Wrench or an Adjustable Wrench, remove the Threaded Cap from the Frame Assembly.

Note: If the Threaded Cap will not come loose, it may be set with a thread lock compound. Using a Heat Gun, safely heat the Threaded Cap until it can be removed.

! Be sure to follow any manual or safety instructions supplied from the manufacturer as regards to the proper and safe use of the Heat Gun. Do not grasp any items or surfaces that have been heated without the proper heat resistant materials.



9. Use the small standard screwdriver to remove the Wedge Bushing exposed behind the Threaded Cap from the Frame Assembly, or safely tilt the machine until the Wedge Bushing falls from the Frame Assembly.

Note: Be sure to notice how the Wedge Bushing engages within the Frame Assembly to assist with re-assembly.

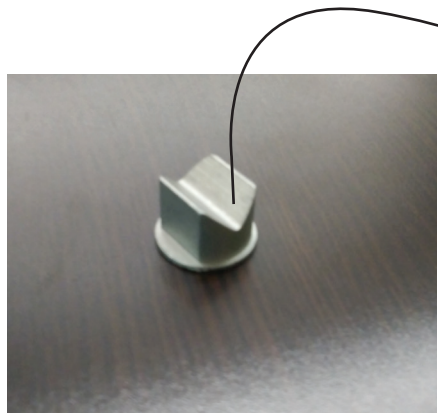

10. On the right-rear side of the Handlebar Post, there is a small opening (indicated by oval) where the Handlebar Bushing Tab is secured. Place the end of a small standard screwdriver into the opening, and push the tab in while pivoting upward the Bushing.

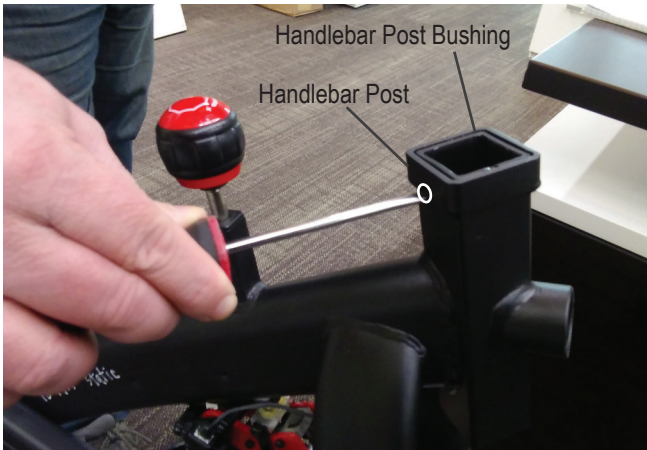

11. With the Handlebar Post Bushing released, place the end of the screwdriver under the lip of the Bushing. Pivot upward until the Handlebar Post Bushing is released. Continue pushing upward to remove the Bushing.



12. Install the new Handlebar Post Bushing into the Frame Assembly. Be sure to orient the new Handlebar Post Bushing so the securing tab sets into the small opening.

13. Re-install all remaining parts that were removed in reverse order.

14. If not replacing the Seat Post Bushing, skip to Step 21.



15. Being prepared to support the Seat Post Assembly, loosen the Seat Post Adjustment Knob and remove the Seat Post Assembly from the Frame Assembly. Set the Seat Post Assembly safely aside away from the work area.

16. Remove the Seat Post Adjustment Knob from the Frame Assembly.



17. On the left side of the Seat Post, there is a small opening (indicated by oval) where the Seat Post Bushing Tab is secured. Place the end of a small standard screwdriver into the opening, and push the tab in while pivoting upward the Bushing.

18. With the Seat Post Bushing released, place the end of the screwdriver under the lip of the Bushing. Pivot upward until the Handlebar Post Bushing is released. Continue pushing upward to remove the Bushing.

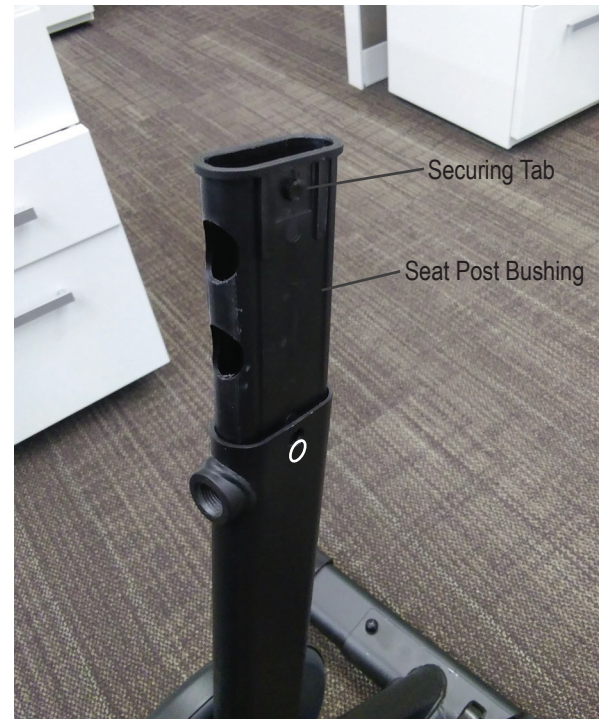

19. Install the new Seat Post Bushing into the Frame Assembly. Be sure to orient the new Seat Post Bushing so the securing tab is to the left side and will set into the small opening.

20. Re-install all remaining parts that were removed in reverse order.

21. Final Inspection

Inspect your machine to ensure that all hardware is tight and components are properly assembled.



Do not use until the machine has been fully assembled and inspected for correct performance in accordance with the Owner's Manual.

NOTICE: This document provides instructions for the replacement of the Pedals on the Schwinn™ IC4 / IC8 / 800IC and Bowflex™ C6 Bikes. The Pedals **MUST** be installed straight into the Crank Arms by hand or the threads that secure the Pedals may strip.

⚠ If the threads strip due to improper installation, then the Pedals can disengage from the bike and/or break while under usage, which can result in serious injury to the user.

Note: The Left Pedal is reverse-threaded. Be sure to attach the Pedals on the proper side of the bike. Orientation is based from a seated position on the bike. The Left Pedal has an "L", the Right Pedal an "R".

If you need assistance, please call Nautilus Customer Service (if purchased in US/Canada) or your local distributor (if purchased outside US/Canada). To find your local distributor, go to: www.nautilusinternational.com

⚠ This icon means a potentially hazardous situation which, if not avoided, could result in death or serious injury. Read and understand all Warnings on this machine.

Nautilus, Inc., www.NautilusInc.com, 5415 Centerpoint Parkway, Groveport, OH 43125 U.S.A. - Customer Service: North America (800) 605-3369, csnls@nautilus.com | outside U.S. www.nautilusinternational.com | Printed in China | © 2020 Nautilus, Inc. | Nautilus, the Nautilus logo, Bowflex and Schwinn are trademarks owned by or licensed to Nautilus, Inc., which are registered or otherwise protected by common law in the United States and other countries. | ORIGINAL DOCUMENT - ENGLISH VERSION ONLY

Important Safety Instructions - Before servicing or using this equipment, obey the following warnings:

⚠ This icon means a potentially hazardous situation which, if not avoided, could result in death or serious injury. Read and understand all Warnings on this machine.

- Read and understand the Part Replacement Procedure before working on the machine. Failure to obey the instructions and safety warnings could cause injury to the service technician or bystanders.
- Keep bystanders and children away from the product being serviced at all times.
- Disconnect all power to the machine before you service it.
- Make sure that the repair is done in an appropriate work space away from foot traffic and exposure to bystanders.
- Some components of the equipment can be heavy or awkward. Enlist the service of a second person when you do maintenance steps involving these components. Do not try to do heavy or awkward steps on your own.
- Use only replacement parts and hardware that are supplied or approved by Nautilus. Failure to use Nautilus-approved replacement parts can adversely affect the safety and functionality of the equipment creating a risk to users and will void the warranty.
- Be sure that all warning stickers and instructional placards applied to the product stay present and in good condition when doing maintenance or replacing components. If at any time the Warning labels become loose, unreadable or dislodged, replace the labels. If purchased in US/Canada, contact Customer Service for replacement labels. If purchased outside US/Canada, contact your local distributor for them.
- Do not try to change the design or functionality of the machine being serviced as this can adversely affect user safety.
- Do not use the machine until all shrouds, instructions, warning labels and correct functionality have been verified and tested for correct performance.

• SAVE THESE INSTRUCTIONS

Tools Required (not included)

15mm Wrench



Blue Loctite® 242 or equivalent
(medium strength)



Note: Your machine may not match the images provided exactly.

1. Unplug the AC Adapter from the wall outlet and machine.
2. Loosen and remove the Pedal.

Note: The Left Pedal is reverse-threaded. Orientation is based from a seated position on the bike. The Left Pedal has an "L", the Right Pedal an "R".

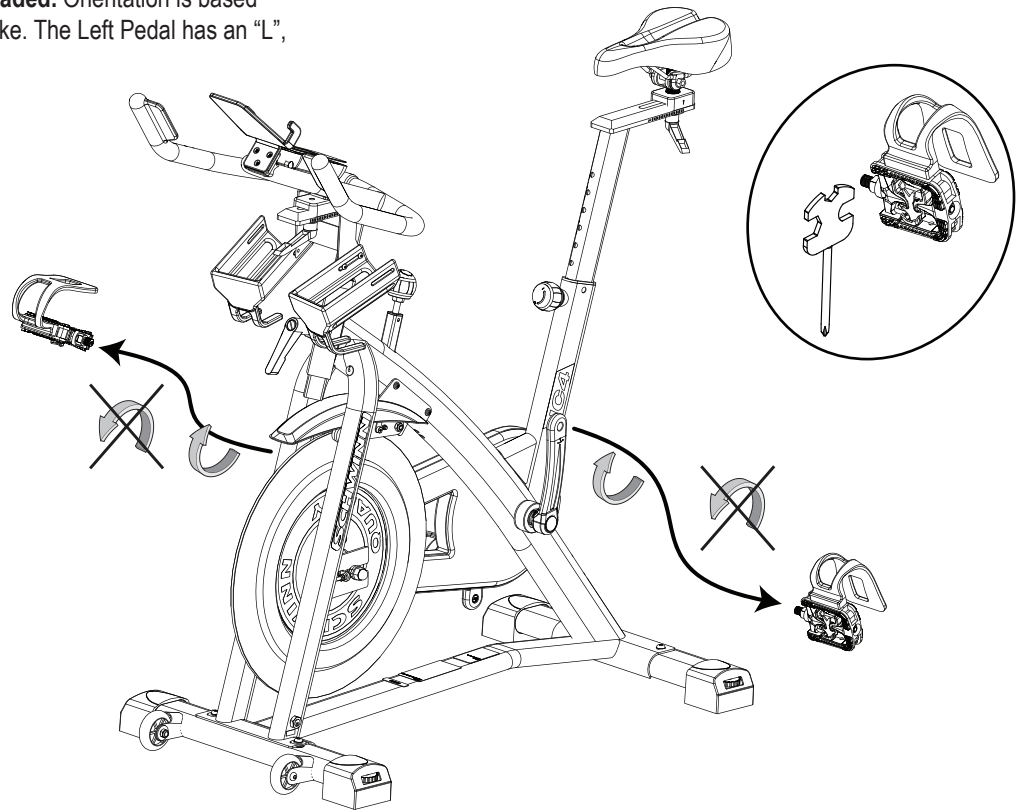

3. Apply Loctite® 242 (or equivalent) to the pedal threads on the new Pedals.

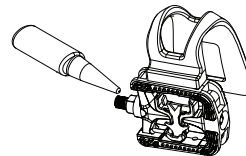

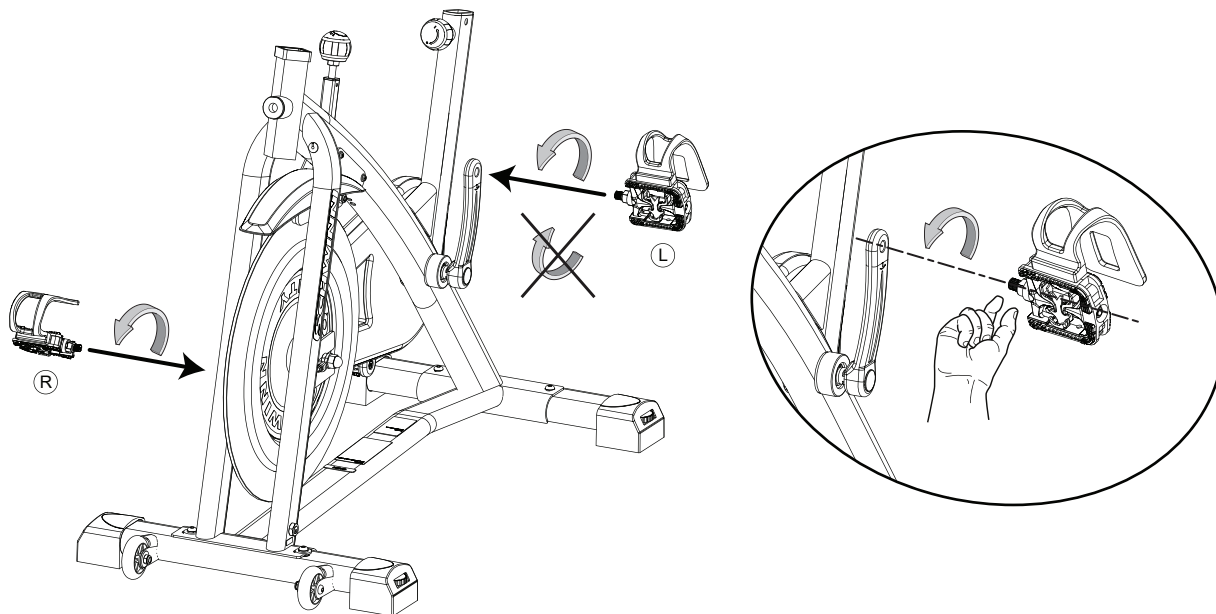

4. Start the Pedal by hand. If you feel resistance and the Pedal does not turn smoothly into the Crank Arm, make sure that the threads are aligned correctly. Be sure that the Pedal is going on straight into the Crank Arm. If the Pedal is not in-line with the opening, remove the Pedal and start again.

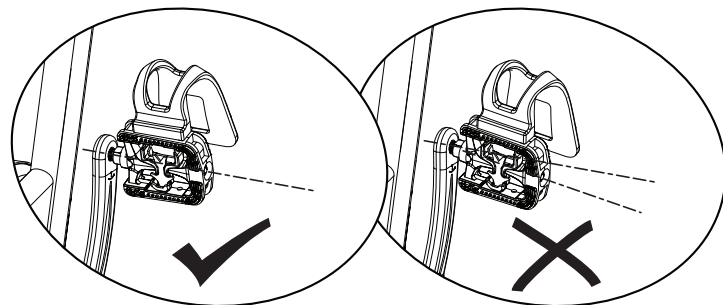

5. With the Pedal started by several hand turns into the Crank Arm, fully tighten it with the Pedal Wrench.

6. Confirm that the Pedal is fully tightened with the Pedal Wrench.

7. Repeat with the other Pedal.

Note: Be sure to check the Pedals weekly to confirm that they are fully tightened.

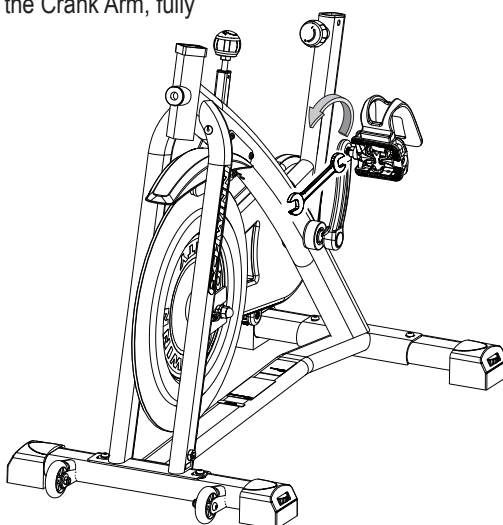

! Since this machine operates with a fixed gear, do not back, or reverse, pedal. Doing so may loosen the Pedals, which could result in damage to the machine and/or injury to the user. Never operate this machine with loose Pedals.

8. Final Inspection

Inspect your machine to ensure that all hardware is tight and components are properly assembled.

! Do not use until the machine has been fully assembled and inspected for correct performance in accordance with the Owner's Manual.

NOTICE: This document provides instructions for the replacement of the Power Inlet on the Schwinn™ IC4 / IC8 / 800IC and Bowflex™ C6 Bikes.

If you need assistance, please call Nautilus Customer Service (if purchased in US/Canada) or your local distributor (if purchased outside US/Canada). To find your local distributor, go to: www.nautilusinternational.com

 **This icon means a potentially hazardous situation which, if not avoided, could result in death or serious injury. Read and understand all Warnings on this machine.**

Nautilus, Inc., www.NautilusInc.com, 5415 Centerpoint Parkway, Groveport, OH 43125 U.S.A. - Customer Service: North America (800) 605-3369, csnls@nautilus.com | outside U.S. www.nautilusinternational.com | Printed in China | © 2020 Nautilus, Inc. | Nautilus, the Nautilus logo, Bowflex and Schwinn are trademarks owned by or licensed to Nautilus, Inc., which are registered or otherwise protected by common law in the United States and other countries. | ORIGINAL DOCUMENT - ENGLISH VERSION ONLY

Important Safety Instructions - Before servicing or using this equipment, obey the following warnings:

 **This icon means a potentially hazardous situation which, if not avoided, could result in death or serious injury. Read and understand all Warnings on this machine.**

- Read and understand the Part Replacement Procedure before working on the machine. Failure to obey the instructions and safety warnings could cause injury to the service technician or bystanders.
- Keep bystanders and children away from the product being serviced at all times.
- Disconnect all power to the machine before you service it.
- Make sure that the repair is done in an appropriate work space away from foot traffic and exposure to bystanders.
- Some components of the equipment can be heavy or awkward. Enlist the service of a second person when you do maintenance steps involving these components. Do not try to do heavy or awkward steps on your own.
- Use only replacement parts and hardware that are supplied or approved by Nautilus. Failure to use Nautilus-approved replacement parts can adversely affect the safety and functionality of the equipment creating a risk to users and will void the warranty.
- Be sure that all warning stickers and instructional placards applied to the product stay present and in good condition when doing maintenance or replacing components. If at any time the Warning labels become loose, unreadable or dislodged, replace the labels. If purchased in US/Canada, contact Customer Service for replacement labels. If purchased outside US/Canada, contact your local distributor for them.
- Do not try to change the design or functionality of the machine being serviced as this can adversely affect user safety.
- Do not use the machine until all shrouds, instructions, warning labels and correct functionality have been verified and tested for correct performance.

• SAVE THESE INSTRUCTIONS

Tools Required (not included)

14mm Wrench



Note: Your machine may not match the images provided exactly.

1. Unplug the AC Adapter from the wall outlet and machine.
2. Fully turn the Resistance Knob clockwise to lock the Flywheel into place.



3. Remove the Console Cable Grommet from the Frame Assembly.



4. Gently push the Console Cable into the Frame Assembly up to where the Resistance Cable joins it, which is about 2.5cm (1").

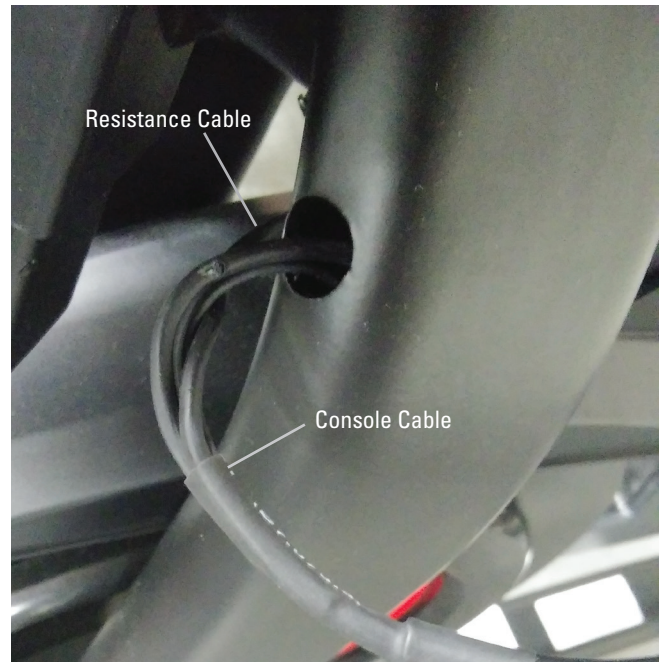

5. Using a 14mm Open Faced Wrench, remove the securing ring from the Power Inlet.



6. Remove the Power Inlet Grommet that is on the other side of the Frame Assembly from the Power Inlet.

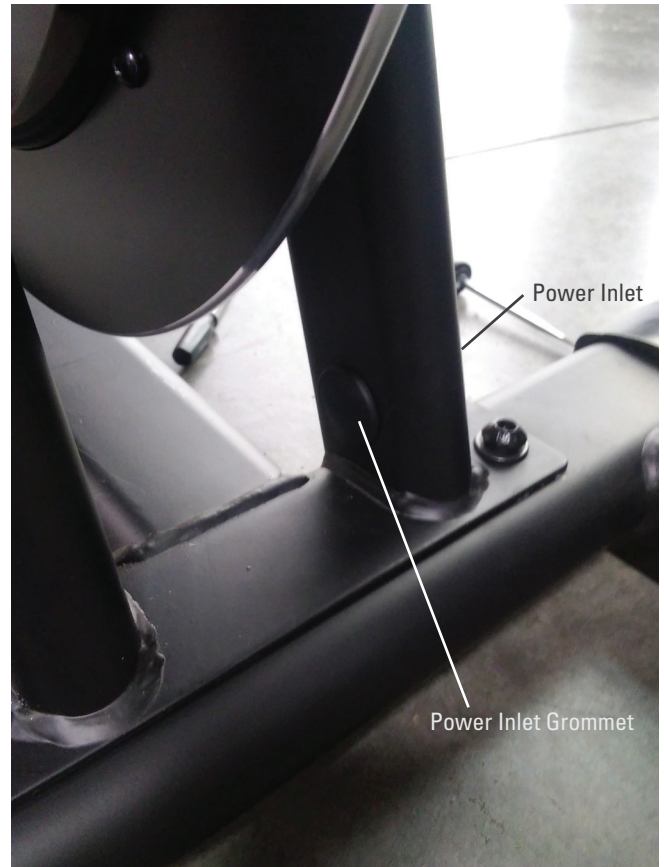

7. From the Power Inlet Grommet opening, gently pull the Power Inlet Cable from the Frame Assembly.

8. Remove the old Power Inlet Cable from the Power Input Connection, and replace with the new Power Inlet Cable.

9. Gently pivot the Power Inlet Cable into place on the Frame Assembly, and secure it to the Frame Assembly with the securing ring.

10. Replace the Power Inlet Grommet. Be sure not to push it into the Frame Assembly.

11. Gently pull out the slack of the Console Cable from the Frame Assembly to the original position.



12. Replace the Console Cable Grommet.

NOTICE: Do not crimp the Cable.

13. Final Inspection

Inspect your machine to ensure that all hardware is tight and components are properly assembled.



Do not use until the machine has been fully assembled and inspected for correct performance in accordance with the Owner's Manual.

NOTICE: This document provides instructions for the replacement of the Resistance Sensor and Sensor Magnet on the Schwinn™ IC4 / IC8 / 800IC and Bowflex™ C6 Bikes.

If you need assistance, please call Nautilus Customer Service (if purchased in US/Canada) or your local distributor (if purchased outside US/Canada). To find your local distributor, go to: www.nautilusinternational.com

 **This icon means a potentially hazardous situation which, if not avoided, could result in death or serious injury. Read and understand all Warnings on this machine.**

Nautilus, Inc., www.NautilusInc.com, 5415 Centerpoint Parkway, Groveport, OH 43125 U.S.A. - Customer Service: North America (800) 605-3369, csnls@nautilus.com | outside U.S. www.nautilusinternational.com | Printed in China | © 2020 Nautilus, Inc. | Nautilus, the Nautilus logo, Bowflex and Schwinn are trademarks owned by or licensed to Nautilus, Inc., which are registered or otherwise protected by common law in the United States and other countries. | ORIGINAL DOCUMENT - ENGLISH VERSION ONLY

Important Safety Instructions - Before servicing or using this equipment, obey the following warnings:

 **This icon means a potentially hazardous situation which, if not avoided, could result in death or serious injury. Read and understand all Warnings on this machine.**

- Read and understand the Part Replacement Procedure before working on the machine. Failure to obey the instructions and safety warnings could cause injury to the service technician or bystanders.
- Keep bystanders and children away from the product being serviced at all times.
- Disconnect all power to the machine before you service it.
- Make sure that the repair is done in an appropriate work space away from foot traffic and exposure to bystanders.
- Some components of the equipment can be heavy or awkward. Enlist the service of a second person when you do maintenance steps involving these components. Do not try to do heavy or awkward steps on your own.
- Use only replacement parts and hardware that are supplied or approved by Nautilus. Failure to use Nautilus-approved replacement parts can adversely affect the safety and functionality of the equipment creating a risk to users and will void the warranty.
- Be sure that all warning stickers and instructional placards applied to the product stay present and in good condition when doing maintenance or replacing components. If at any time the Warning labels become loose, unreadable or dislodged, replace the labels. If purchased in US/Canada, contact Customer Service for replacement labels. If purchased outside US/Canada, contact your local distributor for them.
- Do not try to change the design or functionality of the machine being serviced as this can adversely affect user safety.
- Do not use the machine until all shrouds, instructions, warning labels and correct functionality have been verified and tested for correct performance.

• SAVE THESE INSTRUCTIONS

Tools Required (not included)

#2 Phillips screwdriver



Note: Your machine may not match the images provided exactly.

1. Unplug the AC Adapter from the wall outlet and machine.

2. Using a #2 Phillips screwdriver, loosen and remove the hardware (indicated on one side by ovals) that attaches the Fender to the Main Frame. Set the hardware safely aside for reassembly.

NOTICE: Hold the Fender so that it does not fall.

3. Remove the Fender from the front of the machine after noting how the Resistance Cable routes through it. Place the Fender outside the work area.



4. Using a #2 Phillips screwdriver, remove the hardware (indicated by ovals) that secures the Resistance Sensor. Allow the Resistance Sensor to hang from the Resistance Cable.

NOTICE: Do not crimp the cable.



5. Remove the old Resistance Sensor from the end of the Resistance Cable, and replace it with the new Resistance Sensor.

6. Remove the old Resistance Sensor Magnet after noting the flat segments are oriented up and downward, and attach the new Resistance Sensor Magnet in the same orientation.

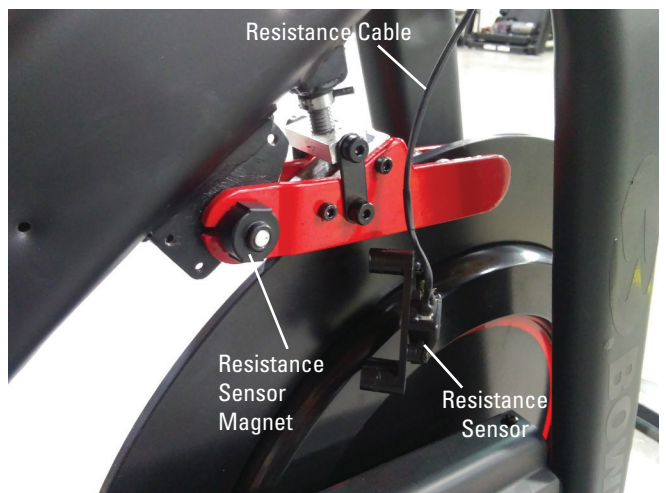

7. Re-install all remaining parts that were removed in reverse order.

NOTICE: Do not crimp any cables.

Re-install the Fender, making sure the Resistance Cable is routed between the Frame and the top of the Fender.



8. Plug the AC Adapter from the wall outlet to the machine.

9. With the Console activated and in Power-Up mode, push the START/ENTER button.

10. Within 5 seconds of completing Step 9, push and hold down the Reset and Increase buttons for 3 seconds. The Console is now in Service Mode.

11. Now push and hold down the Reset and Increase buttons again for 3 seconds. The Console is now in the Calibrate the Magnetic Resistance Sensor option (display with placeholders shown).

12. The Console displays four values with one of them flashing.

Note: The Magnetic Resistance Sensor can only be calibrated three times. If the Console displays the Calibration Round as “3”, then it cannot be calibrated again.

The upper value is the current position supplied by the Resistance Knob. This is the value controlled by the user.

The 1% Configured Value is the previously calibrated position for the 1% Resistance Value. This value is the first to be calibrated and is the one flashing.

Turn the Resistance Knob counter-clockwise until it is unable to turn, and then turn it clockwise a quarter of a turn.

13. Push the START/ENTER button to set this value as the new 1% Configured Value. The Console will update the displayed value.

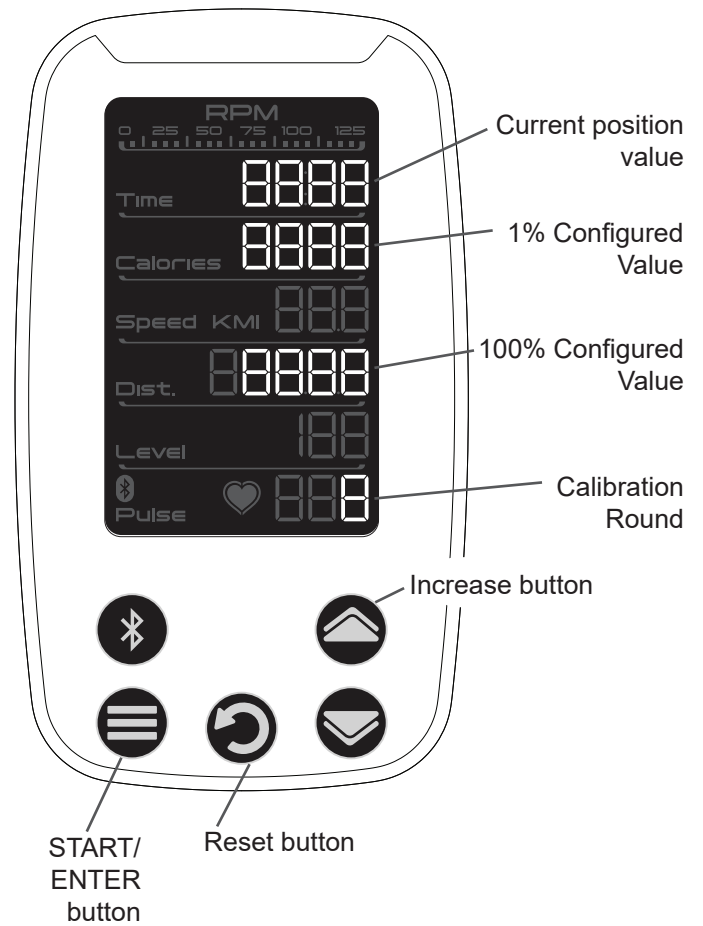

14. The Console will now flash the 100% Configured Value. The 100% Configured Value is the previously calibrated position for the 100% Resistance Value.

With one hand on the front of the Flywheel, slightly turn the Flywheel while turning the Resistance Knob clockwise. Immediately stop turning the Resistance Knob when the Flywheel is unable to turn.

 **Be sure to keep fingers clear of all pinch hazards as you slightly turn the Flywheel.**

15. Turn the Resistance Knob counter-clockwise one full turn.

16. Confirm that the Flywheel can move by turning it. If the Flywheel cannot turn, the Resistance Knob has been turned too far. Go back to Step 14.

17. Push the START/ENTER button to set this value as the new 100% Configured Value. The Console will update the displayed value.

18. Unplug the machine from the power adapter for 5 minutes, and then plug it back into the machine. The Console will activate with the Magnetic Resistance Sensor calibrated to the new positions.

19. Final Inspection

Inspect your machine to ensure that all hardware is tight and components are properly assembled.

 **Do not use until the machine has been fully assembled and inspected for correct performance in accordance with the Owner's Manual.**



NOTICE: This document provides instructions for the replacement of the Speed Sensor on the Schwinn™ IC4 / IC8 / 800IC and Bowflex™ C6 Bikes.

If you need assistance, please call Nautilus Customer Service (if purchased in US/Canada) or your local distributor (if purchased outside US/Canada). To find your local distributor, go to: www.nautilusinternational.com

This icon means a potentially hazardous situation which, if not avoided, could result in death or serious injury. Read and understand all Warnings on this machine.

Nautilus, Inc., www.NautilusInc.com, 5415 Centerpoint Parkway, Groveport, OH 43125 U.S.A. - Customer Service: North America (800) 605-3369, csnls@nautilus.com | outside U.S. www.nautilusinternational.com | Printed in China | © 2019 Nautilus, Inc. | Nautilus, the Nautilus logo, Bowflex and Schwinn are trademarks owned by or licensed to Nautilus, Inc., which are registered or otherwise protected by common law in the United States and other countries. | ORIGINAL DOCUMENT - ENGLISH VERSION ONLY

Important Safety Instructions - Before servicing or using this equipment, obey the following warnings:

This icon means a potentially hazardous situation which, if not avoided, could result in death or serious injury. Read and understand all Warnings on this machine.

- Read and understand the Part Replacement Procedure before working on the machine. Failure to obey the instructions and safety warnings could cause injury to the service technician or bystanders.
- Keep bystanders and children away from the product being serviced at all times.
- Disconnect all power to the machine before you service it.
- Make sure that the repair is done in an appropriate work space away from foot traffic and exposure to bystanders.
- Some components of the equipment can be heavy or awkward. Enlist the service of a second person when you do maintenance steps involving these components. Do not try to do heavy or awkward steps on your own.
- Use only replacement parts and hardware that are supplied or approved by Nautilus. Failure to use Nautilus-approved replacement parts can adversely affect the safety and functionality of the equipment creating a risk to users and will void the warranty.
- Be sure that all warning stickers and instructional placards applied to the product stay present and in good condition when doing maintenance or replacing components. If at any time the Warning labels become loose, unreadable or dislodged, replace the labels. If purchased in US/Canada, contact Customer Service for replacement labels. If purchased outside US/Canada, contact your local distributor for them.
- Do not try to change the design or functionality of the machine being serviced as this can adversely affect user safety.
- Do not use the machine until all shrouds, instructions, warning labels and correct functionality have been verified and tested for correct performance.

• SAVE THESE INSTRUCTIONS

Tools Required (not included)

#2 Phillips screwdriver		15mm Wrench 10mm Wrench	
Small flathead screwdriver		16mm Socket and Wrench 15mm Socket and Wrench	
25mm Crank puller		3.5mm Hex wrench 5mm Hex wrench	
Red Loctite® 272 or equivalent (high strength)		Tape or marking pen	

NOTICE: At the end of this procedure, make sure that the Drive Belt tension is correct. Refer to the “Adjust the Belt Tension” procedure.

Note: Your machine may not match the images provided exactly.

1. Unplug the AC Adapter from the wall outlet and machine.
2. Fully turn the Resistance Knob clockwise to lock the Flywheel into place.
3. Using a flathead screwdriver, remove the threaded Cap from the right Crank Arm.



4. Using a 16mm socket and wrench, remove the Crank Nut under the threaded Cap.

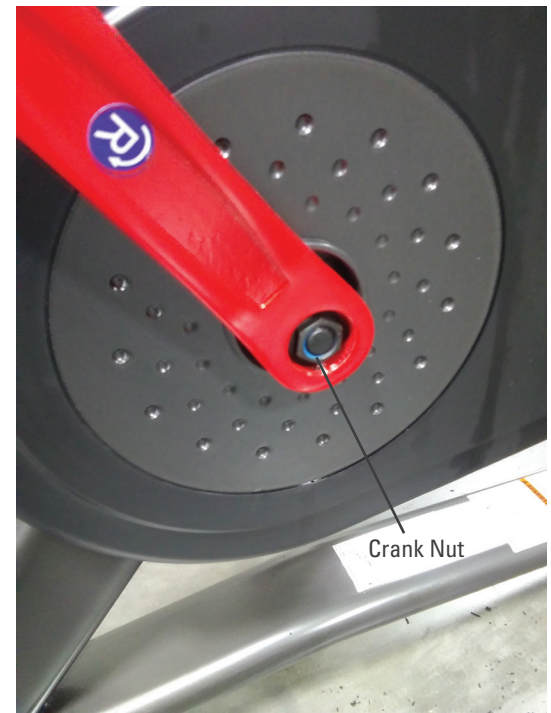

5. Thread the Crank Puller into the Crank Arm. When the Crank Puller is in the correct position, only 1-2 threads on the outer portion (CP2) of the Crank Puller should show.

Note: Be sure the end of the Bolt (CP1) in the Crank Puller is flush with the inner surface (CP2) as shown, before use.

6. Using a 15mm wrench, turn the inner portion (CP3) of the Crank Puller clockwise. The Crank Arm will slide off as it is tightened.

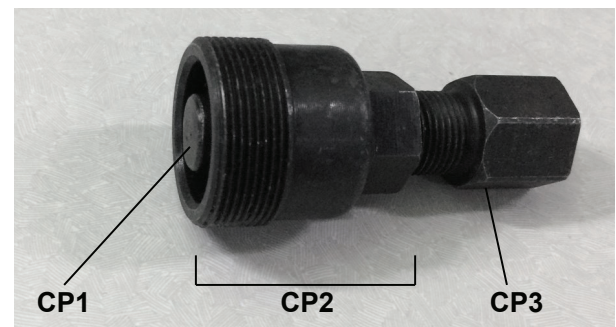

7. Using a #2 Phillips screwdriver, loosen and remove the hardware (indicated on one side by ovals) that attaches the Fender to the Main Frame. Set the hardware safely aside for reassembly.

NOTICE: Hold the Fender so that it does not fall.

8. Remove the Fender from the front of the machine after noting how the Resistance Cable routes through it. Place the Fender outside the work area.

9. Loosen the Resistance Knob to the minimum resistance setting.



10. Using a #2 Phillips screwdriver, remove the hardware (indicated by ovals) that secures the Resistance Sensor. Allow the Resistance Sensor to hang from the Cable.

NOTICE: Do not crimp the cable.

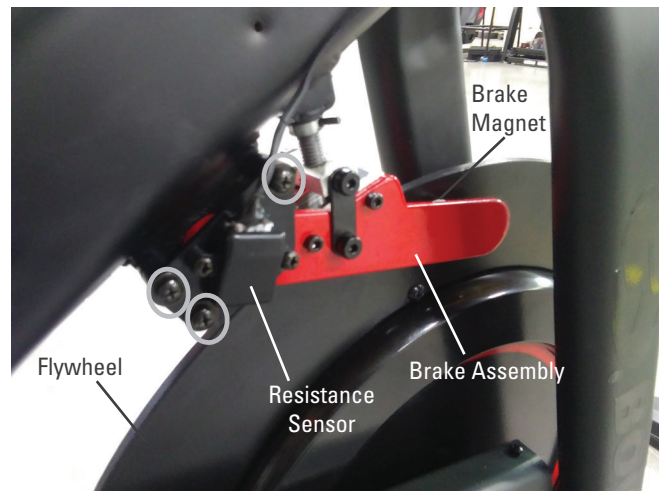

11. Remove the Resistance Sensor Magnet after noting the flat segments are oriented up and downward. This will assist with re-assembly.



12. Using a 10mm open end wrench and a 5mm hex wrench, remove the hardware (indicated by arrows) from both sides of the machine.



13. Using a 3.5mm hex wrench, remove the hardware (indicated by ovals) that attaches the Brake Assembly to the Resistance Nut from both sides of the machine. Carefully remove the Brake Assembly.

NOTICE: Be prepared to support the Brake Assembly.

14. Using a #2 Phillips screwdriver, remove the indicated hardware from the Drive Belt Cover. Carefully remove the Drive Belt Cover and set it safely aside for reassembly.

Note: The oval indicates the two machine screws with washers.

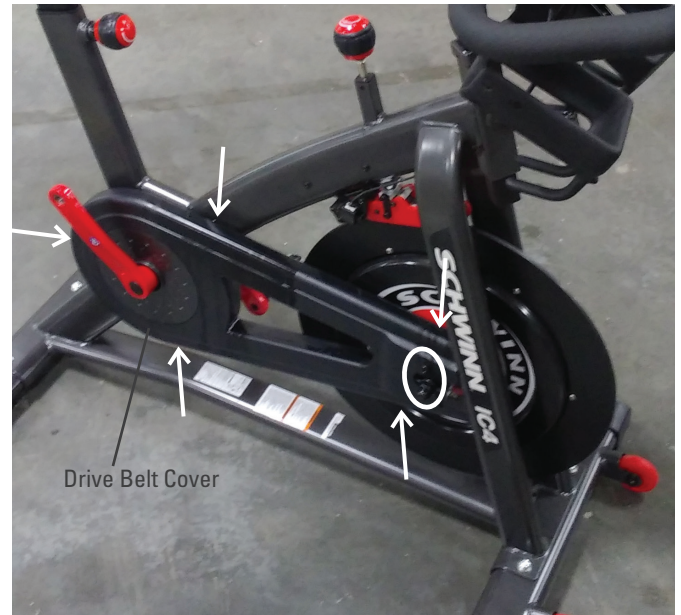

Note: Please disregard the Right Crank Arm in the above image. It was removed during an earlier step.

15. Mark the position of the Flywheel Axle Nut on the Flywheel Bracket. Also record the number of threads showing on the Tensioner Eyebolt on each side of the Tensioner Support Bracket.

16. To loosen the Flywheel hardware, use a 15mm crescent wrench to hold the Flywheel Axle Nut on one side steady and loosen the Flywheel Axle Nut on the opposite side with a 15mm socket and wrench. Remove the Flywheel Axle Nuts from the Flywheel Axle. Set the hardware safely aside for reassembly.



17. Using a 10mm wrench, loosen and remove the outer Flywheel Retainer Nut from the Tensioner Eyebolt. Remove the Tensioner Eyebolt and inner Retaining Nut from the Flywheel Axle and Tensioner Support Bracket. Set the Tensioner hardware aside for reassembly.

NOTICE: It may be necessary to move the Flywheel. This step may require two people.



18. Pull the Lower Rubber Grommet out of the Left Frame Upright to expose the wire connector.

19. Disconnect the Speed Sensor Cable from the wire harness, being careful not to push wire harness connector back into the Left Frame Upright.

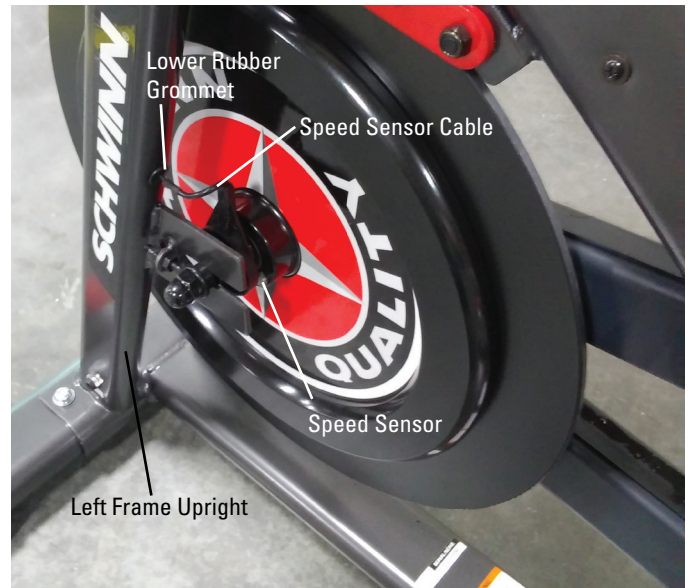

20. Carefully move the Flywheel to the opening in the Flywheel Brackets, and then remove the Flywheel from the Flywheel Bracket. Remove the Thin Nut from the left end of the Axle and set it safely aside for reassembly.

NOTICE: This step may require two people.

21. Carefully remove the Speed Sensor and Spacer from the Axle. Set the old Speed Sensor safely aside.

NOTICE: This step may require two people.

22. Put the new Speed Sensor and Spacer in position on the Axle. Reinstall the Thin Nut on the Axle.

NOTICE: This step may require two people. Do not crimp any cables

23. Place the Flywheel near the Flywheel Brackets, and put the Drive Belt in position on the Flywheel Pulley. Align the Flywheel Axle in the Flywheel Brackets. Hand tighten the hardware from steps 13 and 14 on each end of the Flywheel Axle.

NOTICE: Do not crimp any cables.

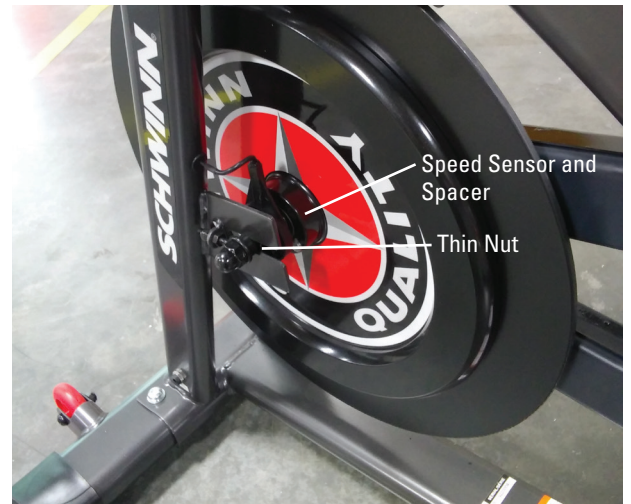

24. Put the Drive Belt around the edge of the Drive Pulley. Slowly turn the Drive Pulley and carefully walk the Drive Belt onto the Drive Pulley. Make sure the Drive Belt is aligned on the Flywheel Pulley and Drive Pulley.



Be sure to keep fingers clear of all pinch hazards as you turn the Drive Pulley and Flywheel.

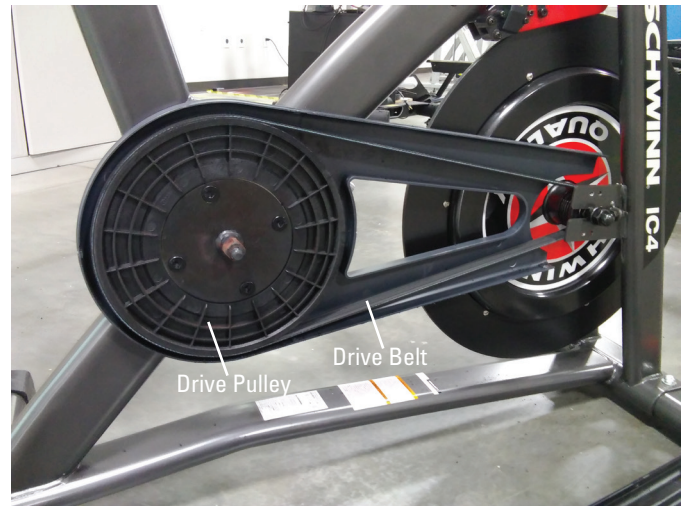

25. Connect the wire connector from the new Speed Sensor Cable to the harness plug, and push the connection into the Left Frame Upright.

26. Reinstall the Lower Rubber Grommet in the lower opening in the Left Frame Upright to hold the Speed Sensor Cable in position.

NOTICE: Do not crimp the cable.

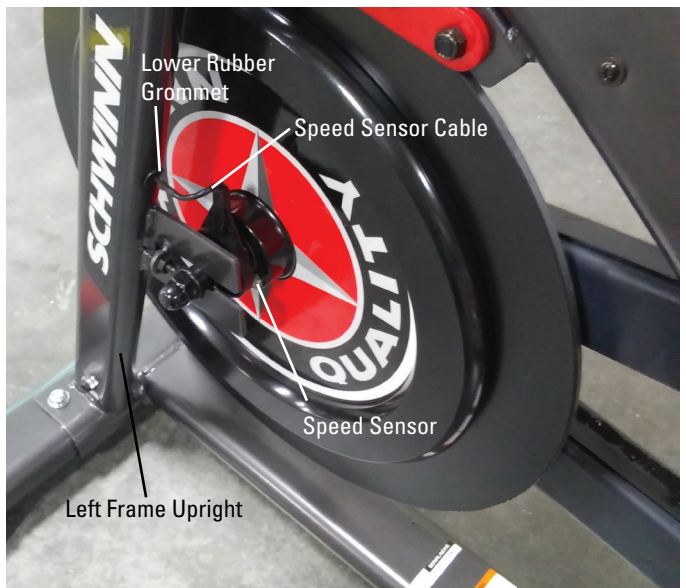

27. Re-install all remaining parts that were removed in reverse order up to the Crank Nut.

NOTICE: Do not crimp any cables. Install the Flywheel Tensioners at the position that you recorded in step 15. Make sure the Flywheel can turn easily. Verify that the Speed Sensor and Speed Sensor Magnet on the Flywheel do not touch.



Re-install the Fender, making sure the Resistance Cable is routed between the Frame and the top of the Fender.

Installation does not require the use of the Crank Puller. Be sure the Crank Arms are connected at 180° from each other.

28. Make sure that the Drive Belt tension is correct. Refer to the “Adjust the Belt Tension” procedure.



29. Add Loctite® 272 (or equivalent) to the inner threads of the Crank Nut. Do not to apply the Loctite® 272 to the Crank Shaft.

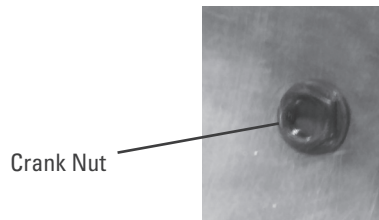

30. Install the Crank Nut onto the Crank Shaft, and fully tighten it.

31. Replace the threaded Cap onto the Crank Arm.

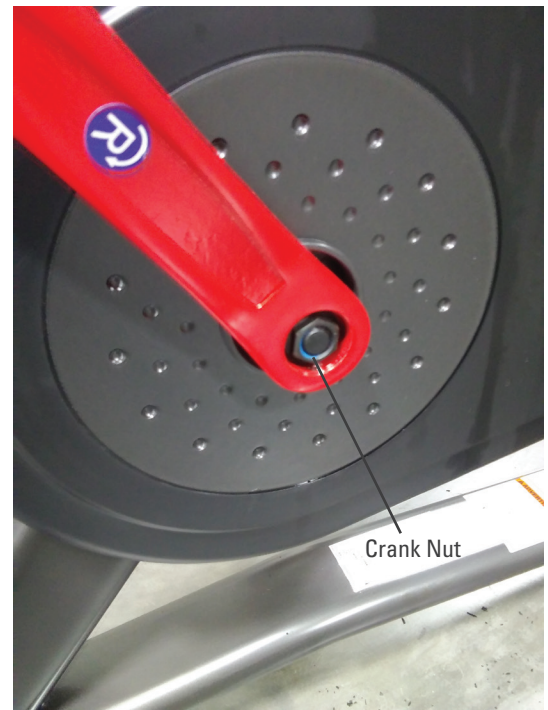

32. Final Inspection

Inspect your machine to ensure that all hardware is tight and components are properly assembled.



Do not use until the machine has been fully assembled and inspected for correct performance in accordance with the Owner's Manual.

NOTICE: This document provides instructions for the replacement of the Wiring Harness on the Schwinn™ IC4 / IC8 / 800IC and Bowflex™ C6 Bikes.

If you need assistance, please call Nautilus Customer Service (if purchased in US/Canada) or your local distributor (if purchased outside US/Canada). To find your local distributor, go to: www.nautilusinternational.com

 **This icon means a potentially hazardous situation which, if not avoided, could result in death or serious injury. Read and understand all Warnings on this machine.**

Nautilus, Inc., www.NautilusInc.com, 5415 Centerpoint Parkway, Groveport, OH 43125 U.S.A. - Customer Service: North America (800) 605-3369, csnl@nautilus.com | outside U.S. www.nautilusinternational.com | Printed in China | © 2020 Nautilus, Inc. | Nautilus, the Nautilus logo, Bowflex and Schwinn are trademarks owned by or licensed to Nautilus, Inc., which are registered or otherwise protected by common law in the United States and other countries. | ORIGINAL DOCUMENT - ENGLISH VERSION ONLY

Important Safety Instructions - Before servicing or using this equipment, obey the following warnings:

 **This icon means a potentially hazardous situation which, if not avoided, could result in death or serious injury. Read and understand all Warnings on this machine.**

- Read and understand the Part Replacement Procedure before working on the machine. Failure to obey the instructions and safety warnings could cause injury to the service technician or bystanders.
- Keep bystanders and children away from the product being serviced at all times.
- Disconnect all power to the machine before you service it.
- Make sure that the repair is done in an appropriate work space away from foot traffic and exposure to bystanders.
- Some components of the equipment can be heavy or awkward. Enlist the service of a second person when you do maintenance steps involving these components. Do not try to do heavy or awkward steps on your own.
- Use only replacement parts and hardware that are supplied or approved by Nautilus. Failure to use Nautilus-approved replacement parts can adversely affect the safety and functionality of the equipment creating a risk to users and will void the warranty.
- Be sure that all warning stickers and instructional placards applied to the product stay present and in good condition when doing maintenance or replacing components. If at any time the Warning labels become loose, unreadable or dislodged, replace the labels. If purchased in US/Canada, contact Customer Service for replacement labels. If purchased outside US/Canada, contact your local distributor for them.
- Do not try to change the design or functionality of the machine being serviced as this can adversely affect user safety.
- Do not use the machine until all shrouds, instructions, warning labels and correct functionality have been verified and tested for correct performance.

• SAVE THESE INSTRUCTIONS

Tools Required (not included)

#2 Phillips screwdriver



14mm Wrench



(2) Pieces of string, 1.2m (4') in length each

Something to cut a Zip-Tie



Note: Your machine may not match the images provided exactly.

1. Unplug the AC Adapter from the wall outlet and machine.
2. Fully turn the Resistance Knob clockwise to lock the Flywheel into place.
3. Disconnect the Console Cable from the Console Cable Connector.
4. Remove the Console Cable Grommet from the Frame Assembly.
5. Using a #2 Phillips screwdriver, loosen and remove the hardware (indicated on one side by ovals) that attaches the Fender to the Main Frame. Set the hardware safely aside for reassembly.
NOTICE: Hold the Fender so that it does not fall.
6. Remove the Fender from the front of the machine after noting how the Resistance Cable routes through it. Place the Fender outside the work area.

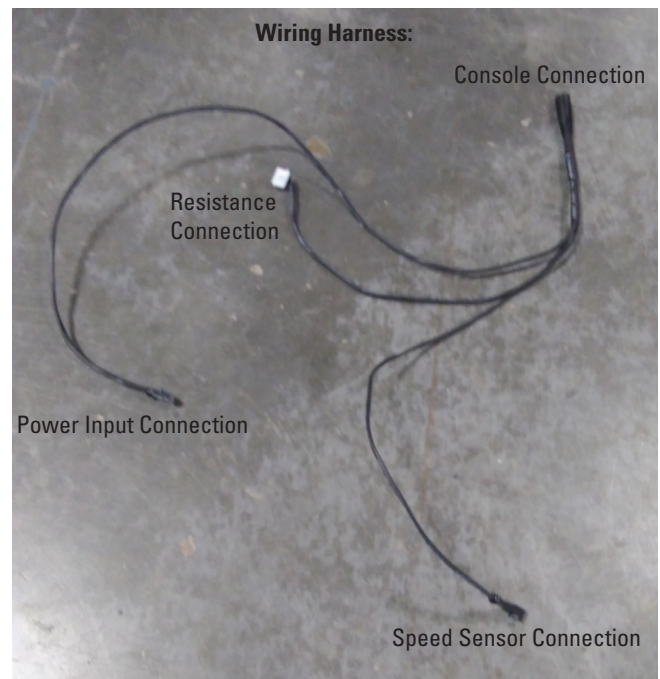

7. Remove the Resistance Cable from the Brake Assembly.

Note: If present, remove any adhesive used to secure the Cable.

8. Using a pair of clippers or scissors, cut the Zip-Tie that secures the Resistance Cable to the Frame Assembly.

Note: Be sure not to cut the Cable.

9. Remove the Resistance Cable Grommet from the Frame Assembly that captures the Resistance Cable.

Note: The Resistance Cable Grommet is needed for shipment of the machine only. The Grommet does not need to be re-installed and can be discarded.



10. Remove the Speed Sensor Grommet from the Frame Assembly that captures the Speed Sensor Cable.



11. Gently pull the Speed Sensor Cable from the Frame Assembly just enough to locate the Speed Sensor Connectors, and disconnect them.



12. Attach a string to the end of the Speed Sensor Connection.

NOTICE: Do not crimp the Cable.



13. Using a 14mm Open Faced Wrench, remove the securing ring from the Power Inlet.



14. Remove the Power Inlet Grommet that is on the other side of the Frame Assembly from the Power Inlet.

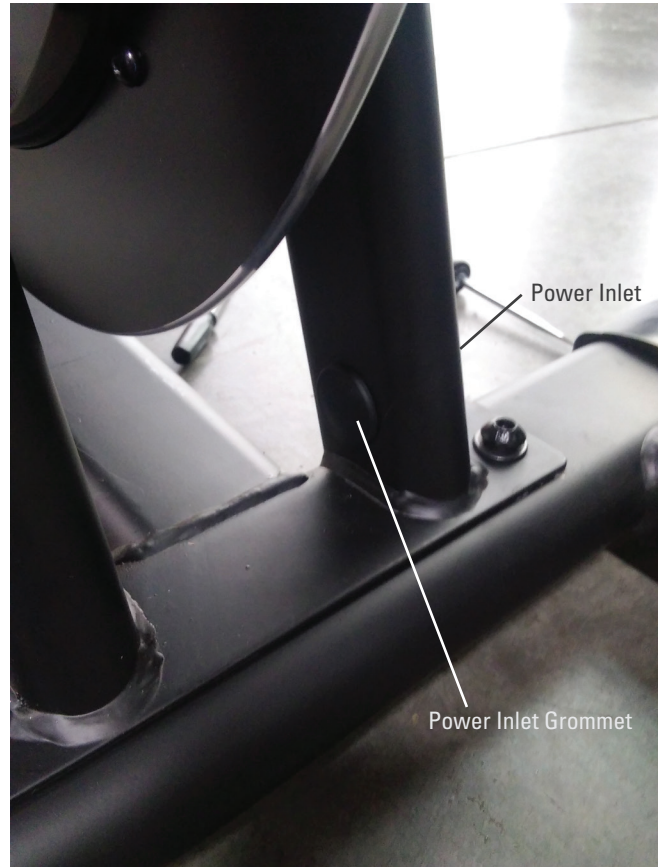

15. From the Power Inlet Grommet opening, gently pull the Power Inlet Cable from the Frame Assembly.

16. Remove the Power Inlet Cable from the Power Input Connection.



17. Attach the second string to the Power Input Connection.

NOTICE: Do not crimp the Cable.

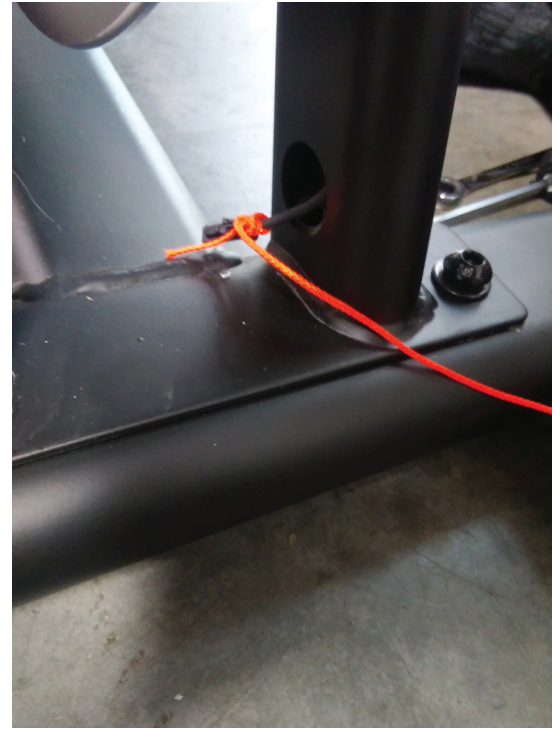

18. Gently pull the old Wiring Harness from the Frame Assembly while guiding the Speed Sensor and Power Input Connection into the Frame Assembly. Continue pulling until the strings are fully routed through the Frame Assembly, and stop pulling when both ends of each string are exposed.

Note: If the Wiring Harness becomes hard to pull or snagged at any point, briefly pull the strings in the opposite direction to release them.

19. Holding the new Wiring Harness next to the old one, remove the string from the old Speed Sensor Connection and attach it to the new Speed Sensor Connection. Be sure that it is the Speed Sensor Connection and not the other Connections.

20. Remove the string from the end of the old Power Input Connection, and attach it to the new Power Input Connection.

21. Route the new Wiring Harness through the Frame Assembly by gently pulling the strings one at a time, being sure to alternate between the strings every couple of inches of routing.

NOTICE: Do not crimp the Cables.

22. With the new Wiring Harness fully routed, remove the strings. Connect the Speed Sensor Cable.

NOTICE: Do not crimp the Cable.



23. Connect the Power Inlet Cable to the Power Input Connector of the Wiring Harness.

24. Gently pivot the Power Inlet Cable into place on the Frame Assembly, and secure it to the Frame Assembly with the securing ring.

25. Gently pull the slack of the Console and Resistance Cables upward out of the Frame Assembly, gradually feeding the Power Inlet and Speed Sensor Connectors into the Frame Assembly.

26. Replace the Power Inlet Grommet. Be sure not to push it into the Frame Assembly.

27. Replace the Speed Sensor Grommet.

NOTICE: Do not crimp the Cable.

28. Replace the Console Cable Grommet.

NOTICE: Do not crimp the Cable.

29. Connect the Resistance Cable.

NOTICE: Do not crimp the Cable.

30. Re-install the Fender, making sure the Resistance Cable is routed between the Frame and the top of the Fender.

31. Connect the Console to Console Cable.

32. Final Inspection

Inspect your machine to ensure that all hardware is tight and components are properly assembled.



Do not use until the machine has been fully assembled and inspected for correct performance in accordance with the Owner's Manual.

