

**BOWFLEX**

**MAX**  
TRAINER

M16

OWNER'S / ASSEMBLY MANUAL



# Table of Contents / Registration

Important Safety Instructions	3	Mounting / Dismounting	31
Safety Warning Labels / Serial Number	5	Getting Started	32
Specifications	6	Power Up / Idle Mode	32
Before Assembly	6	Warm Up Mode	33
Parts	7	MAX 14 MINUTE INTERVAL Program	33
Hardware	8	Edit a User Profile	33
Tools	8	Workout Programs	34
Assembly	8	Paused / Results Mode	35
Moving the Machine	18		
Leveling the Machine	18	Console Setup Mode	36
Features	19	Maintenance	37
Console Features	20	Maintenance Parts	38
Using your JRNY™ membership with your machine	22	Troubleshooting	40
Secure your Device	23	Body Weight Loss Plan	42
Fitness Basics	25	Buy Back Guarantee	50
Operations	31	Warranty	51

To validate warranty support, keep the original proof of purchase and record the following information:

**Serial Number** \_\_\_\_\_

**Date of Purchase** \_\_\_\_\_

**If purchased in US/Canada:** To register your product warranty, go to: [www.bowflex.com/register](http://www.bowflex.com/register) or call 1 (800) 605-3369.

**If purchased outside US/Canada:** To register your product warranty, contact your local distributor.

For details regarding product warranty or if you have questions or problems with your product, please contact your local distributor. To find your local distributor, go to: [www.nautilusinternational.com](http://www.nautilusinternational.com)

Nautilus, Inc., 5415 Centerpoint Parkway, Groveport, OH 43125 USA, [www.NautilusInc.com](http://www.NautilusInc.com) - Customer Service: North America (800) 605-3369, [csnls@nautilus.com](mailto:csnls@nautilus.com) | Nautilus (Shanghai) Fitness Equipments Co, Ltd, Room 1701 &1702, 1018 Changning Road, Changning District, Shanghai, China 200042, [www.nautilus.cn](http://www.nautilus.cn) - 86 21 6115 9668 | outside U.S. [www.nautilusinternational.com](http://www.nautilusinternational.com) | Printed in China | © 2018 Nautilus, Inc. | Bowflex, the Bowflex logo, Nautilus, the Nautilus logo, Schwinn, SelectTech, Max Trainer, and JRNY are trademarks owned or licensed by Nautilus, Inc., registered or otherwise protected by common law in the U.S. and other countries. Google Play™, and Nut Thins® are trademarks of their respective owners. Apple and the Apple logo are trademarks of Apple Inc., registered in the U.S. and other countries. App Store is a service mark of Apple Inc. The Bluetooth® word mark and logos are registered trademarks owned by Bluetooth SIG, Inc., and any use of such marks by Nautilus, Inc. is under license.

ORIGINAL MANUAL - ENGLISH VERSION ONLY

# IMPORTANT SAFETY INSTRUCTIONS

When using an electrical appliance, basic precautions should always be followed, including the following:

 This icon means a potentially hazardous situation which, if not avoided, could result in death or serious injury.

Obey the following warnings:

 Read and understand all warnings on this machine.  
Carefully read and understand the Assembly instructions.

**DANGER**

Carefully read and understand the Assembly instructions. Read and understand the complete Manual. Keep the Manual for future reference.

**WARNING**

To decrease the risk of burns, electric shock, or injury to persons, read and understand the complete Owner's Manual. Failure to follow these guidelines can cause a serious or possibly fatal electrical shock or other serious injury.

- Keep bystanders and children away from the product you are assembling at all times.
- Do not connect power supply to the machine until instructed to do so.
- The machine should never be left unattended when plugged in. Unplug from outlet when not in use and before cleaning, maintaining or repairing the machine.
- Before each use, examine the machine for damage to power cord, loose parts or signs of wear. Do not use if found in this condition. If purchased in US/Canada, contact Customer Service for repair information. If purchased outside US/Canada, contact your local distributor for repair information.
- Not intended for use by persons with medical conditions where those conditions may impact the safe operation of the machine or pose a risk of injury to the user.
- Do not drop or put objects into any opening of the machine.
- Never operate this machine with the air openings blocked. Keep the air openings free of lint, hair and the like.
- Do not assemble this machine outdoors or in a wet or moist location.
- Make sure assembly is done in an appropriate work space away from foot traffic and exposure to bystanders.
- Some components of the machine can be heavy or awkward. Use a second person when doing the assembly steps involving these parts. Do not do steps that involve heavy lifting or awkward movements on your own.
- Set up this machine on a solid, level, horizontal surface.
- Do not try to change the design or functionality of this machine. This could compromise the safety of this machine and will void the warranty.
- If replacement parts are necessary, use only genuine Nautilus replacement parts and hardware. Failure to use genuine replacement parts can cause a risk to users, keep the machine from operating correctly and void the warranty.
- Do not use until the machine has been fully assembled and inspected for correct performance in accordance with the Manual.
- Read and understand the complete Manual supplied with this machine before first use. Keep the Manual for future reference.
- Do all assembly steps in the sequence given. Incorrect assembly can lead to injury or incorrect function.

• **SAVE THESE INSTRUCTIONS.**

**Before using this equipment, obey the following warnings:**

-  **Read and understand the complete Manual. Keep the Manual for future reference.**
- Read and understand all warnings on this machine. If at any time the Warning labels become loose, unreadable or dislodged, replace the labels. If purchased in US/Canada, contact Customer Service for replacement labels. If purchased outside US/Canada, contact your local distributor for them.**

- Children must not be let on or near to this machine. Moving parts and other features of the machine can be dangerous to children.
- Not intended for use by anyone under 14 years of age. Individuals between 14 and 17 years of age must be supervised when using this machine.
- Consult a physician before you start an exercise program or a new health and diet plan. Stop exercising if you feel pain or tightness in your chest, become short of breath, or feel faint. Contact your doctor before you use the machine again. Use the values calculated or measured by the machine's computer for reference purposes only. The heart rate displayed on the console is an approximation and should be used for reference only.
- Before each use, examine this machine for loose parts or signs of wear. Do not use if found in this condition. Monitor the Pedals and Crank Arms closely. If purchased in US/Canada, contact Customer Service for repair information. If purchased outside US/Canada, contact your local distributor for repair information.
- Maximum user weight limit: 136 kg (300 lb). Do not use if you are over this weight.
- This machine is for home use only. Do not place or use the machine in a commercial or institutional setting. This includes gyms, corporations, work places, clubs, fitness centers and any public or private entity that has a machine for use by its members, customers, employees or affiliates.
- Do not wear loose clothing or jewelry. This machine contains moving parts. Do not put fingers or other objects into moving parts of the exercise equipment.
- Set up and operate this machine on a solid, level, horizontal surface.
- Make the Pedals stable before you step on them. Use caution when you step on and off the machine.
- Do not operate this machine outdoors or in moist or wet locations.
- Keep at least 0.6 m (24 in) along the side used to access the machine and to the rear of the machine clear. This is the recommended safe distance for access and passage around and emergency dismounts from the machine. Keep third parties out of this space when machine is in use.
- Do not over exert yourself during exercise. Operate the machine in the manner described in this manual.
- Perform all regular and periodic maintenance procedures recommended in the Owner's Manual.
- Keep the Pedals and Handlebars clean and dry.
- Exercise on this machine requires coordination and balance. Be sure to anticipate that changes in speed and resistance level can occur during workouts, and be attentive in order to avoid loss of balance and possible injury.
- This machine cannot stop the Pedals or Upper Handlebars independently of the Resistance Fan. Reduce the pace to slow the Resistance Fan, Upper Handlebars and Pedals to a stop. Do not dismount the machine until the Pedals and Upper Handlebars have come to a complete stop.
- Do not drop or put objects into any opening of the machine.
- Prior to use read and understand the Owner's Manual. The appliance is not to be used by persons with functional limitations and impairments, reduced physical, sensory or mental capabilities, or lack of experience and knowledge.
- This appliance is not intended for use by persons with reduced physical, sensory or mental capabilities, or lack of knowledge, unless they have been given supervision or instruction concerning use of the appliance by a person responsible for their safety. Keep children under the age of 14 away from this machine.
- Children should be supervised to ensure that they do not play with the appliance.
- **SAVE THESE INSTRUCTIONS.**



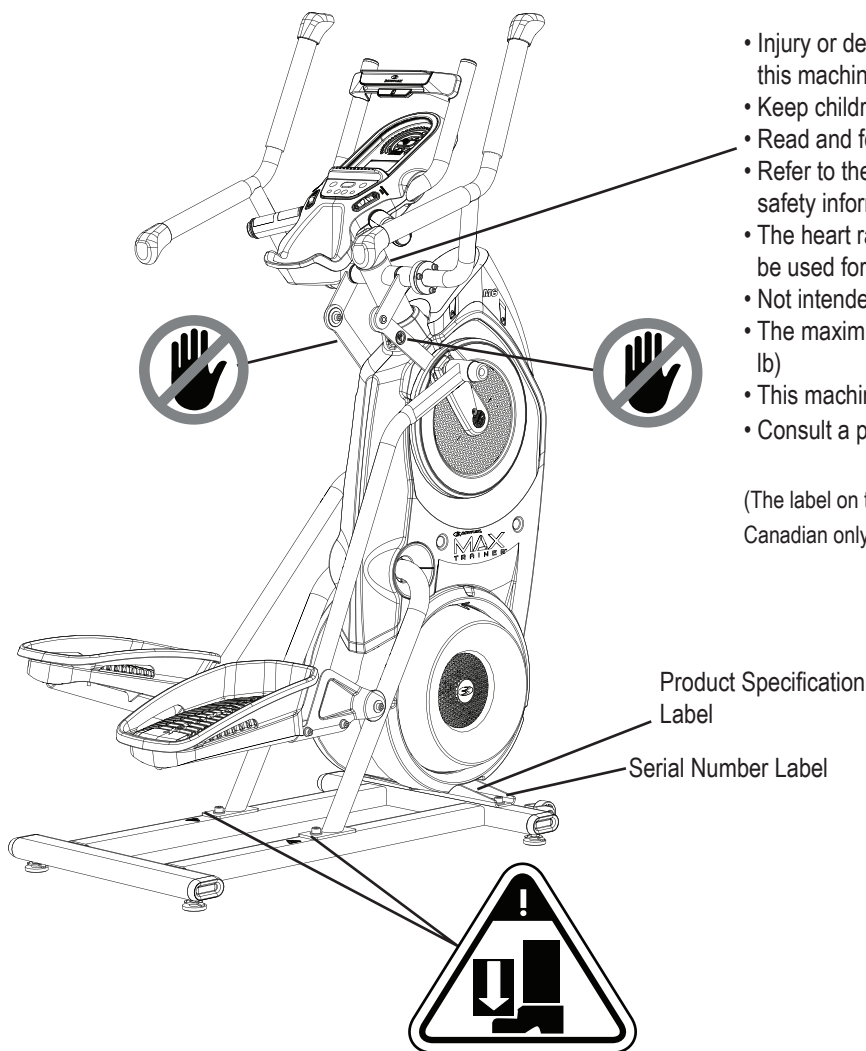

## WARNING!

- Injury or death is possible if caution is not used while using this machine.
- Keep children and pets away.
- Read and follow all warnings on this machine.
- Refer to the Owner's Manual for additional warnings and safety information.
- The heart rate displayed is an approximation and should be used for reference only.
- Not intended for use by anyone under 14 years of age.
- The maximum user weight for this machine is 136 kg. (300 lb)
- This machine is for home use only.
- Consult a physician prior to using any exercise equipment.

(The label on the machine is available in English and French Canadian only.)

Product Specification Label

Serial Number Label

## FCC Compliance

- ⚠ **Changes or modifications to this unit not expressly approved by the party responsible for compliance could void the user's authority to operate the equipment.**

The machine and power supply comply with part 15 of the FCC rules. Operation is subject to the following two conditions: (1) This device may not cause harmful interference, and (2) this device must accept any interference received, including interference that may cause undesired operation.

Note: This machine and power supply have been tested and found to comply with the limits for a Class A digital device, pursuant to Part 15 of the FCC Rules. These limits are designed to provide reasonable protection against harmful interference in a residential installation. This equipment generates, uses and can radiate radio frequency energy and, if not installed and used in accordance with the instructions, may cause harmful interference to radio communications.

However, there is no guarantee that interference will not occur in a particular installation. If this equipment does cause harmful interference to radio or television reception, which can be determined by turning the equipment off and on, the user is encouraged to try to correct the interference by one or more of the following measures:

- Reorient or relocate the receiving antenna.
- Increase the separation between the equipment and receiver.
- Connect the equipment into an outlet on a circuit different from that to which the receiver is connected.
- Consult the dealer or an experienced radio/TV technician for help.

**This product complies with the European Radio Equipment Directive 2014/53/EU**

# Specifications / Before Assembly

- Maximum User Weight:** 136 kg (300 lb)
- Total Surface Area (footprint) of equipment:** 9648.8 cm<sup>2</sup>
- Maximum Pedal Height:** 48.5 cm (19.1 in)
- Machine Weight:** 61.7 kg (136 lb)
- Power Requirements (Power Adapter):**  
Input Voltage: 100-240V AC, 50-60Hz, 0.5A  
Output Voltage: 9V DC, 1.5A

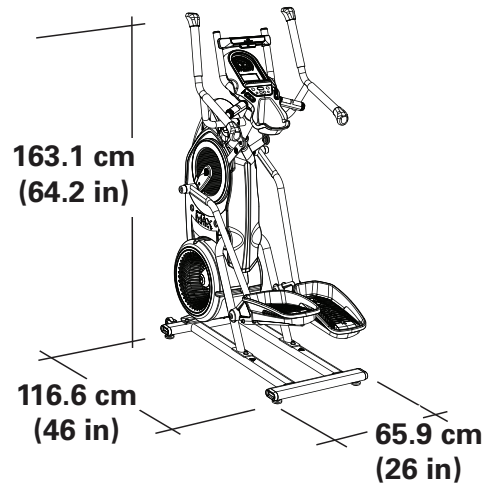

DO NOT dispose of this product as refuse. This product is to be recycled. For proper disposal of this product, please follow the prescribed methods at an approved waste center.

## Before Assembly

Select the area where you are going to set up and operate your machine. For safe operation, the location must be on a hard, level surface. Allow a workout area of a minimum 127 cm (50 in) x 177.8 cm (70 in). Keep the workout area clear 0.6 m (24 in) along the side used to access the machine and to the rear of the machine. Be sure that the workout space you are utilizing has adequate height clearance, taking into consideration the height of the user and the maximum pedal height of the fitness machine.

## Basic Assembly Tips

Follow these basic points when you assemble your machine:

- Read and understand the “Important Safety Instructions” before assembly.
- Collect all the pieces necessary for each assembly step.
- Using the recommended wrenches, turn the bolts and nuts to the right (clockwise) to tighten, and the left (counterclockwise) to loosen, unless instructed otherwise.
- When attaching 2 pieces, lightly lift and look through the bolt holes to help insert the bolt through the holes.
- The assembly requires 2 people.

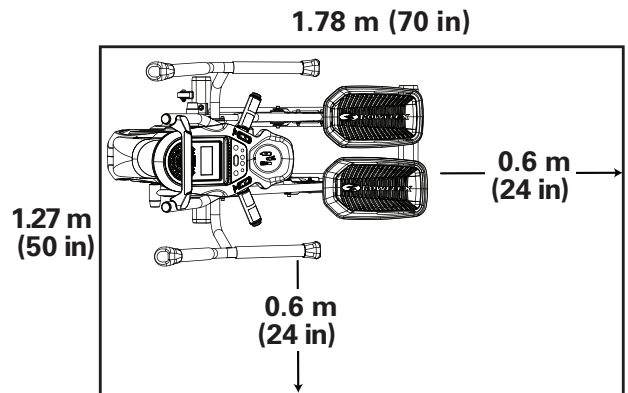

## Machine Mat

The Bowflex™ Max Trainer™ Machine Mat is an optional accessory that helps keep your workout area clear and adds a layer of protection to your floor. The rubber machine mat provides a non-slip, rubber surface which limits static discharge and reduces the possibility of display errors. If possible, put your Bowflex™ Max Trainer™ Machine Mat in your selected workout area before you begin assembly.

To order the optional machine mat, contact Customer Service (if purchased in US/Canada) or your local distributor (if purchased outside US/Canada).

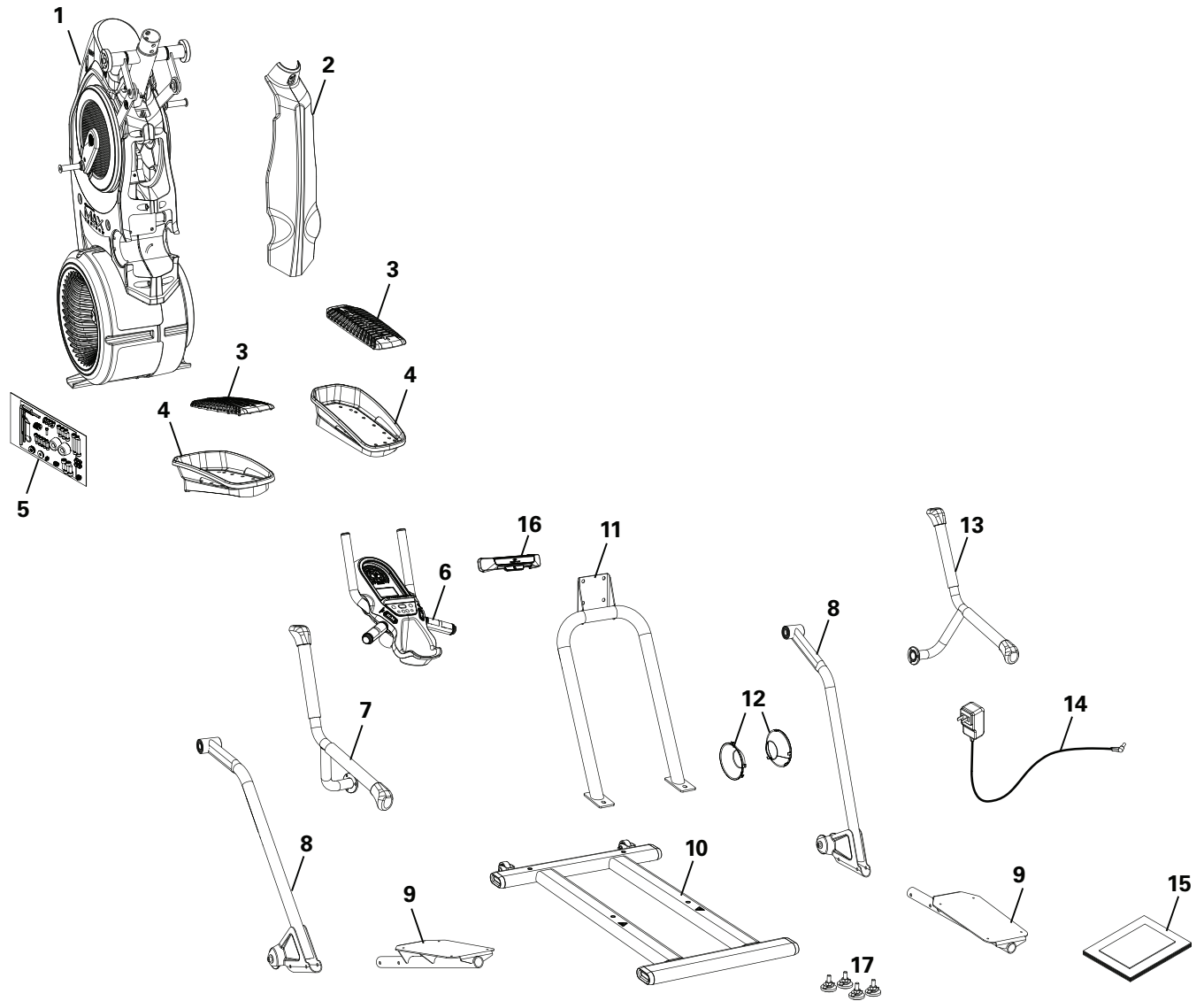

A decal has been applied to all right (" R ") and left (" L ") parts to assist with assembly.

Item	Qty	Description	Item	Qty	Description
1	1	Frame	10	1	Stabilizer Assembly
2	1	Shroud, Rear	11	1	Rail Assembly
3	2	Foot Platform	12	2	Cap
4	2	Foot Pad	13	1	Dynamic Handlebar, Right
5	1	Hardware Card	14	1	AC Adapter
6	1	Console Assembly (w/Aerobars)	15	1	Manual Kit
7	1	Dynamic Handlebar, Left	16	1	Media Capture Bar
8	2	Leg	17	4	Levelers
9	2	Pedal			

# Hardware / Tools

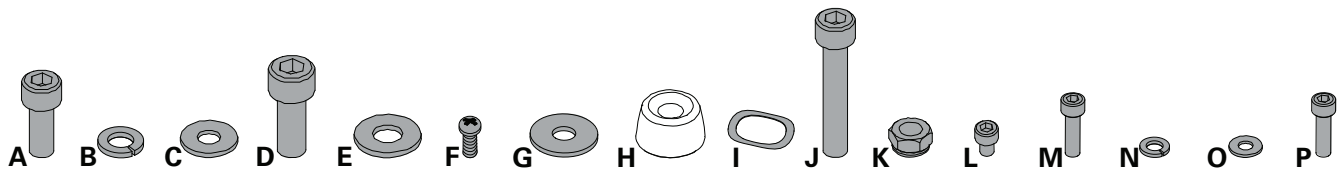

Item	Qty	Description	Item	Qty	Description
A	6	Socket Head Hex Screw, M8x1.25x20 Black	I	2	Wave Washer, 17.2x22 Black
B	6	Lock Washer, M8x14.8 Black	J	4	Socket Head Hex Screw, M8x1.0x55 Black
C	12	Washer, Flat M8x18 Black	K	4	Lock Nut, M8 Black
D	4	Socket Head Hex Screw, M10x1.5x25 Black	L	8	Socket Head Hex Screw, M6x1.0x8 Black
E	4	Washer, Flat M10x23 Black	M	4	Socket Head Hex Screw, M6x1.0x20 CL10.9 Black
F	1	Pan Phillips Screw, M5x0.8x20 Black	N	10	Lock Washer, M6x14.8 Black
G	2	Washer, Flat M8x24 Black	O	4	Washer, Flat M6x13 Black
H	2	Cap	P	6	Socket Head Hex Screw, M6x1.0x20 CL12.9 Black

**Note:** Select pieces of Hardware have been provided as spares on the Hardware Card. Be aware that there may be remaining Hardware after the proper assembly of your machine.

## Tools

Included



#2  
5 mm  
6 mm  
8 mm



13 mm

# Assembly

## 1. Attach Levelers to the Stabilizer Assembly

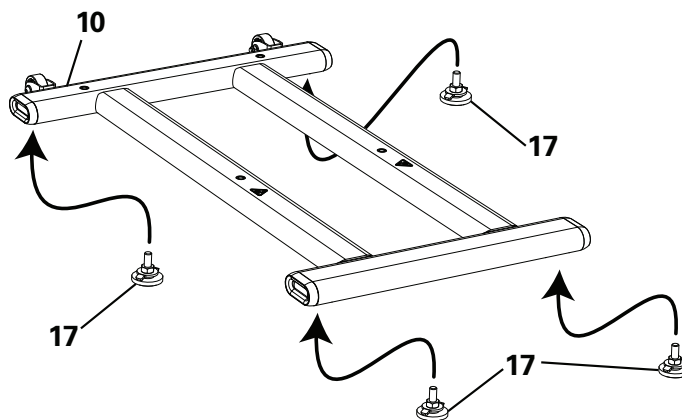

## 2. Attach Rail Assembly to Frame and then Release the Frame from the Shipping Plate

**!** Some components of the machine can be heavy or awkward. Use a second person when doing the assembly steps involving these parts. Do not do steps that involve heavy lifting or awkward movements on your own.

*NOTICE:* Hand tighten hardware.

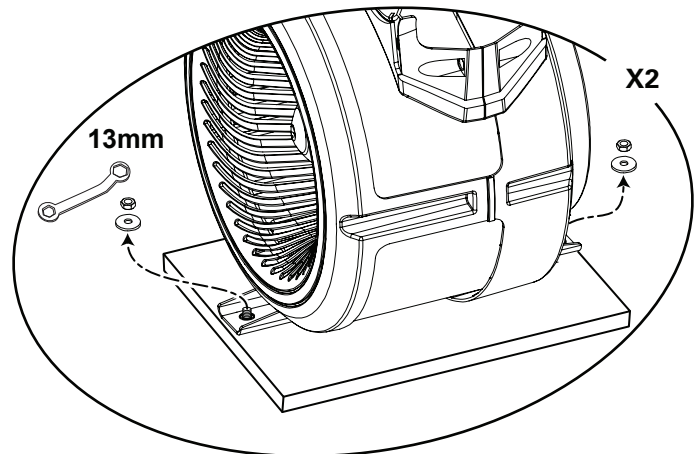
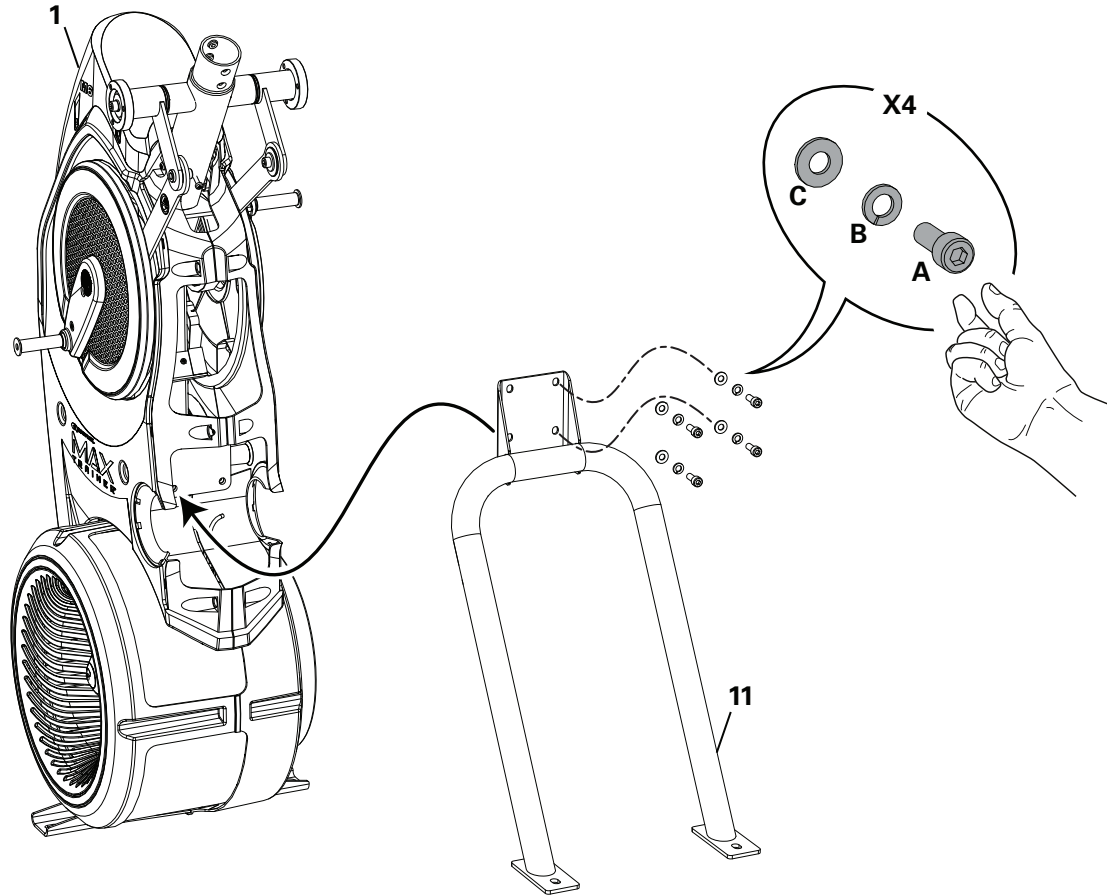

### 3. Carefully Lift the Frame Assembly from the Shipping Plate and Attach to the Stabilizer Assembly

**!** Some components of the machine can be heavy or awkward. Use a second person when doing the assembly steps involving these parts. Do not do steps that involve heavy lifting or awkward movements on your own. Lift the Frame Assembly from the exterior of the pivot assembly as indicated below.

*NOTICE:* Once all hardware has been hand tightened, fully tighten ALL hardware from previous steps.

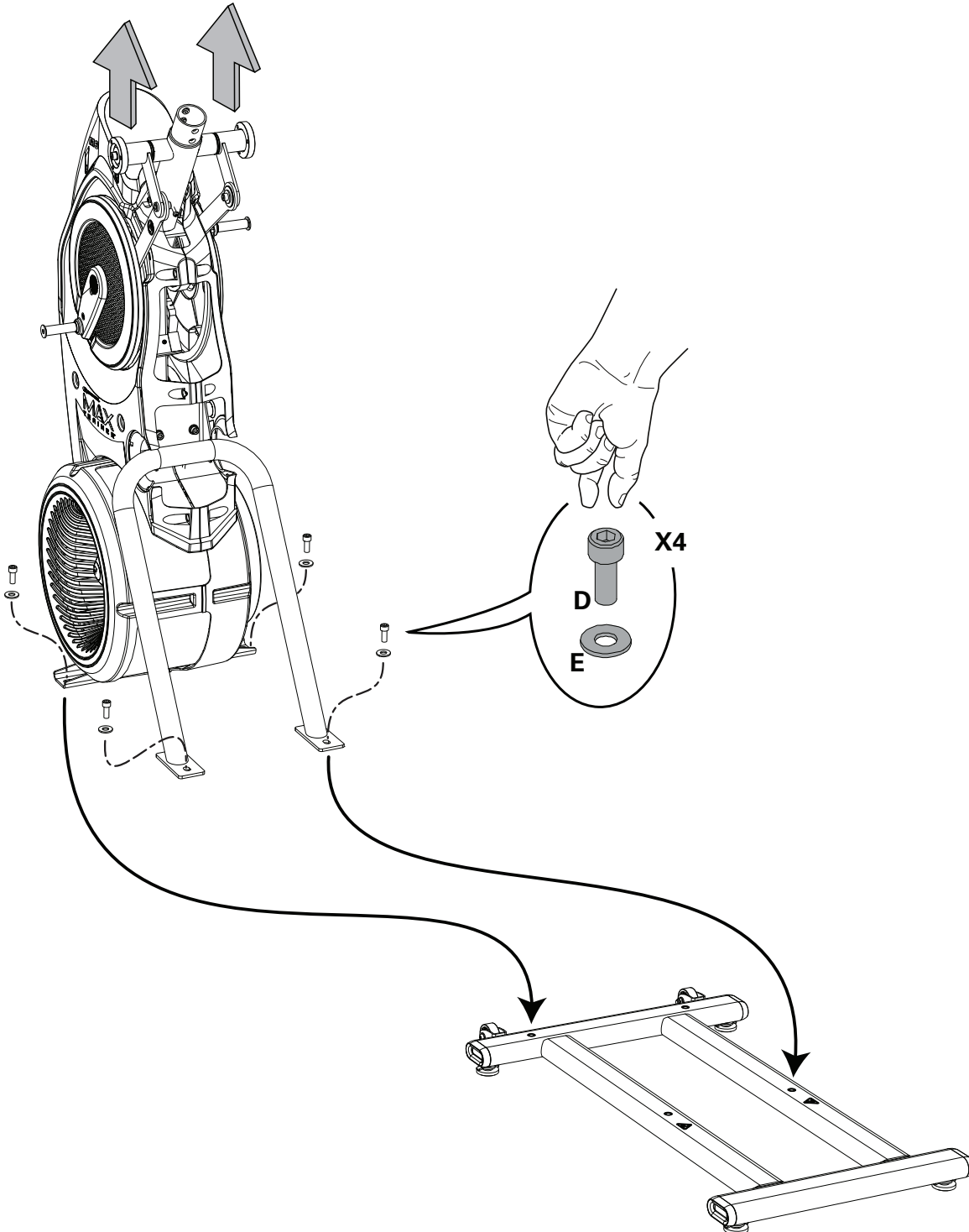



#### 4. Attach Rear Shroud and Caps to the Frame Assembly

*NOTICE:* Place the inside hook of the Rear Shroud on the Frame Assembly and then pivot it up into place.

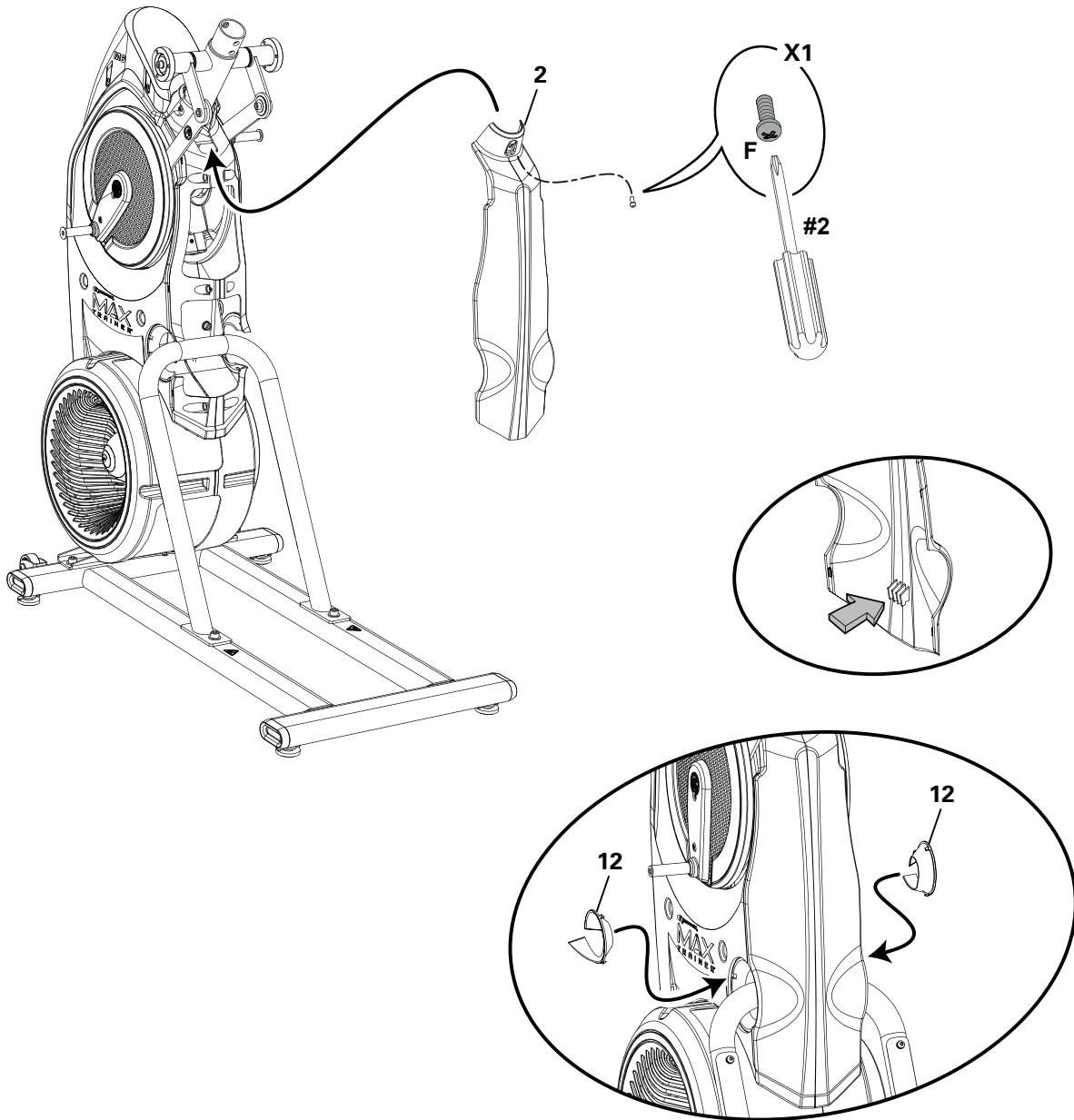

## 5. Attach Legs to Frame Assembly

 Be aware that the Legs are connected and when either of these parts move the other does as well.

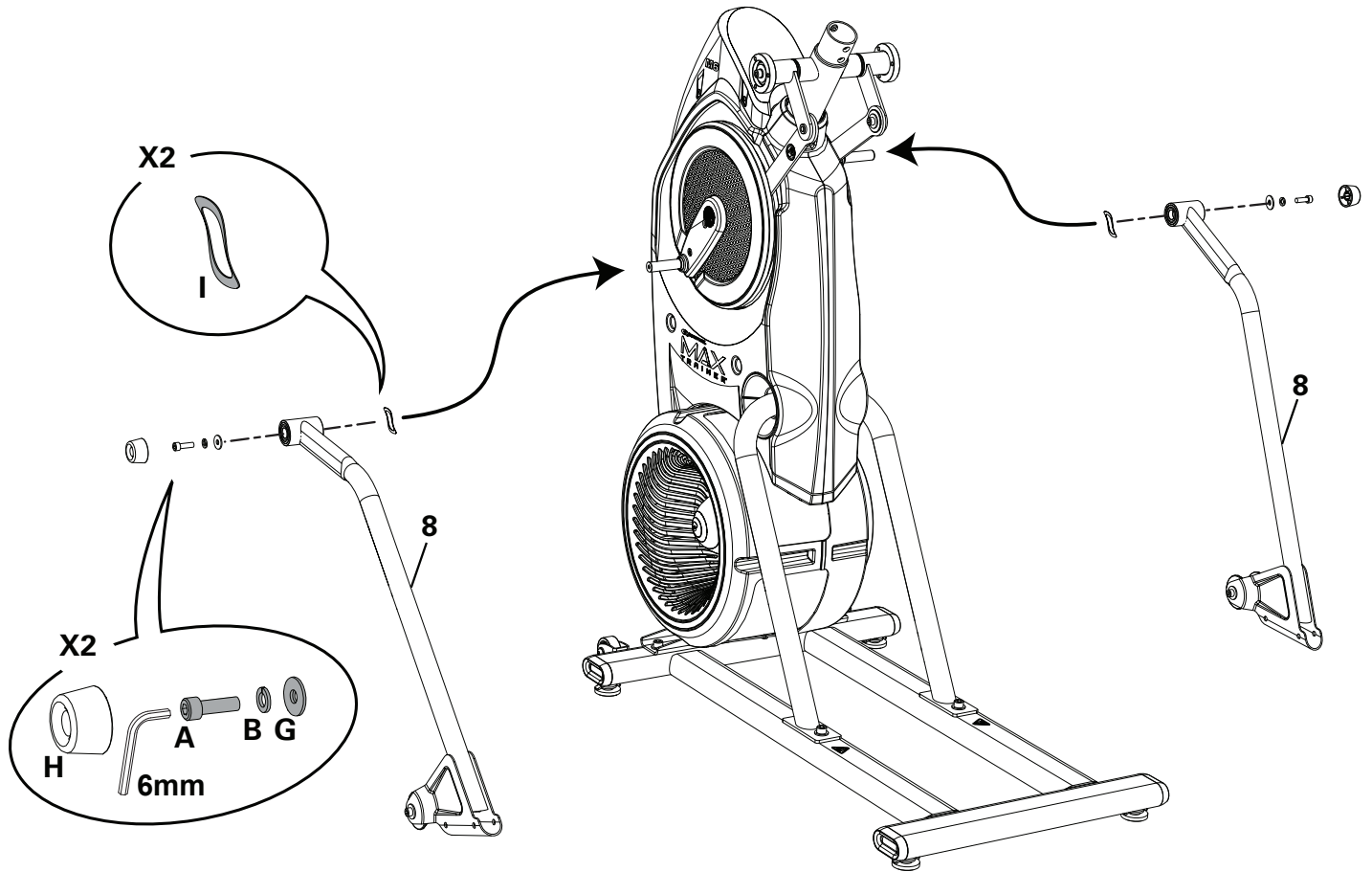

## 6. Attach Pedals to Frame Assembly

**!** In order to avoid possible serious injury, when inserting the tube ends into the Leg Assemblies be careful to avoid fingers or hands being caught or pinched.

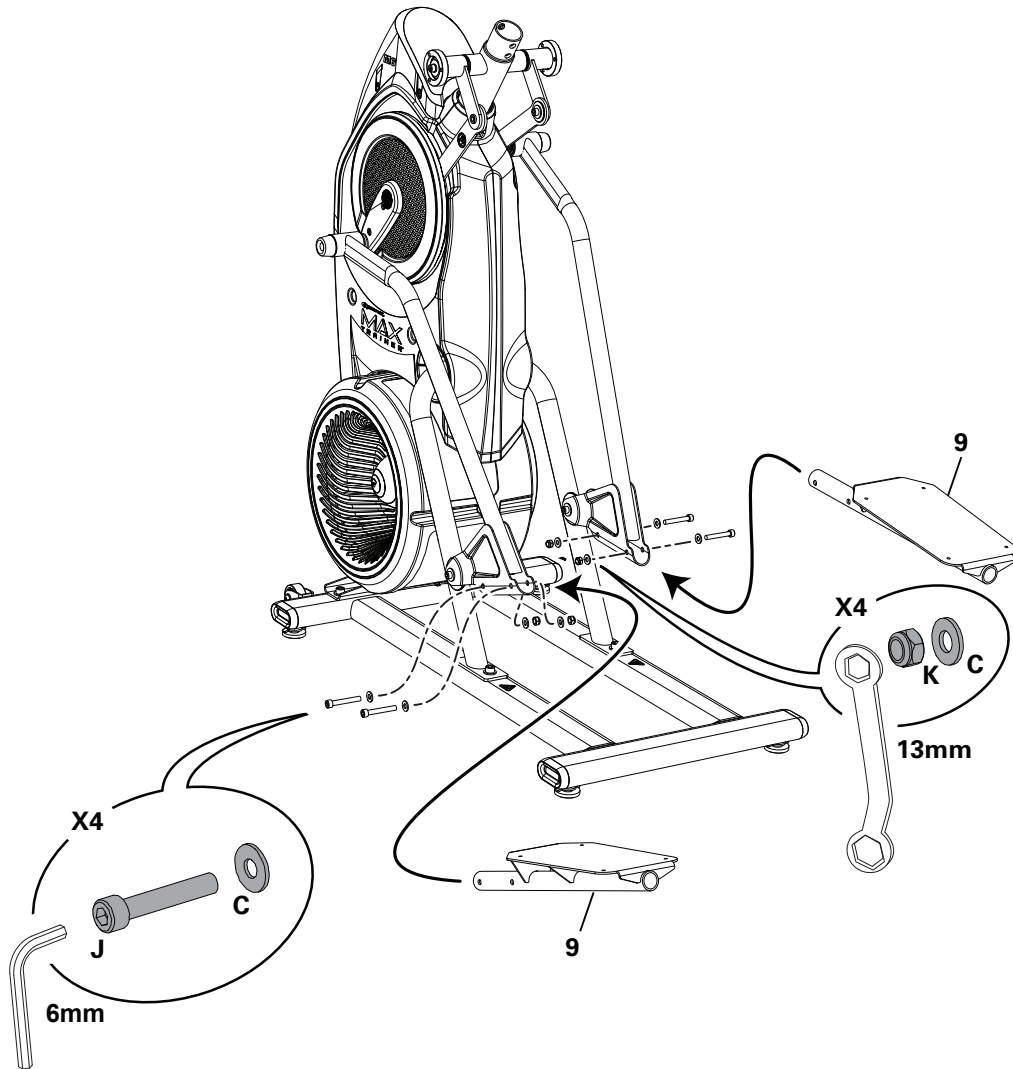

## 7. Attach the Foot Platforms and then the Foot Pads to the Pedals

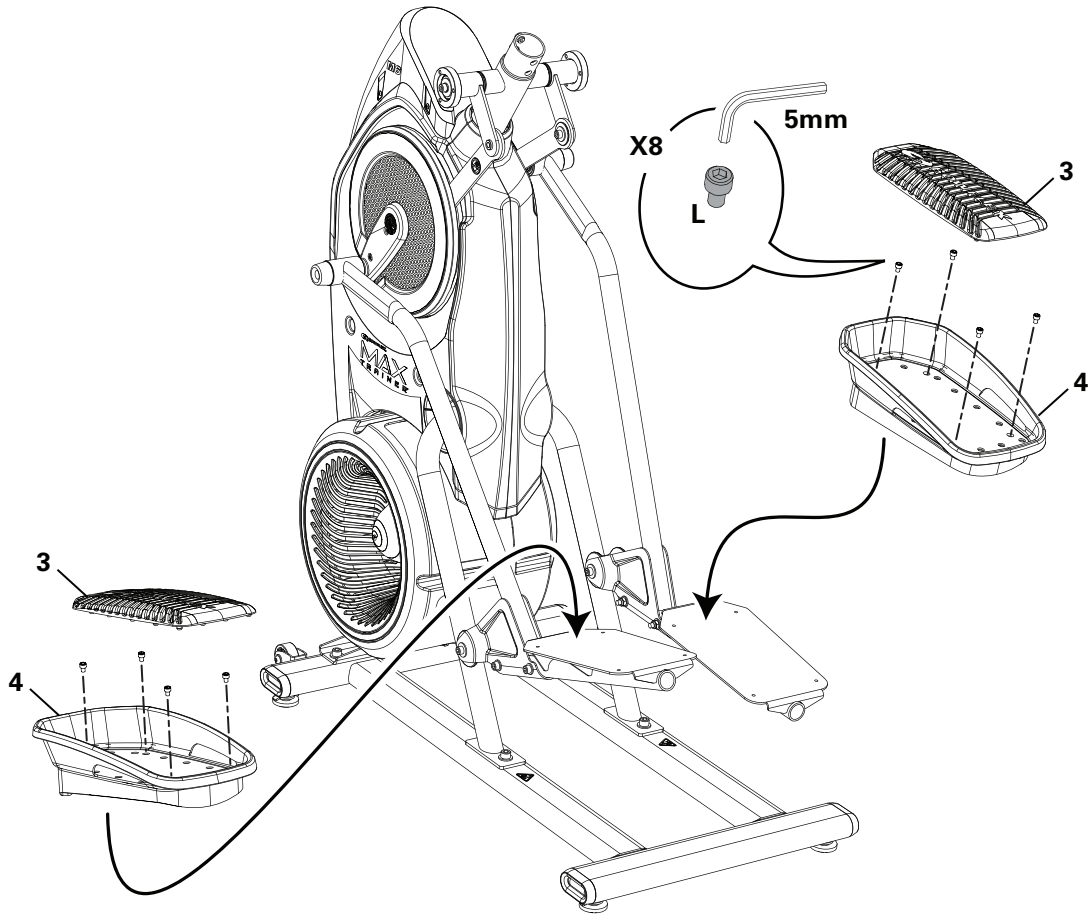

## 8. Cut the Shipping Zip-Tie that Secures the Cables, Connect the Cables, and Attach the Console Assembly and Media Capture Bar

**NOTICE:** Do not let the Cables drop into the Frame Assembly. Do not cut or crimp the Console Cables. Once all hardware has been hand tightened, fully tighten the hardware with the 5mm hex wrench.

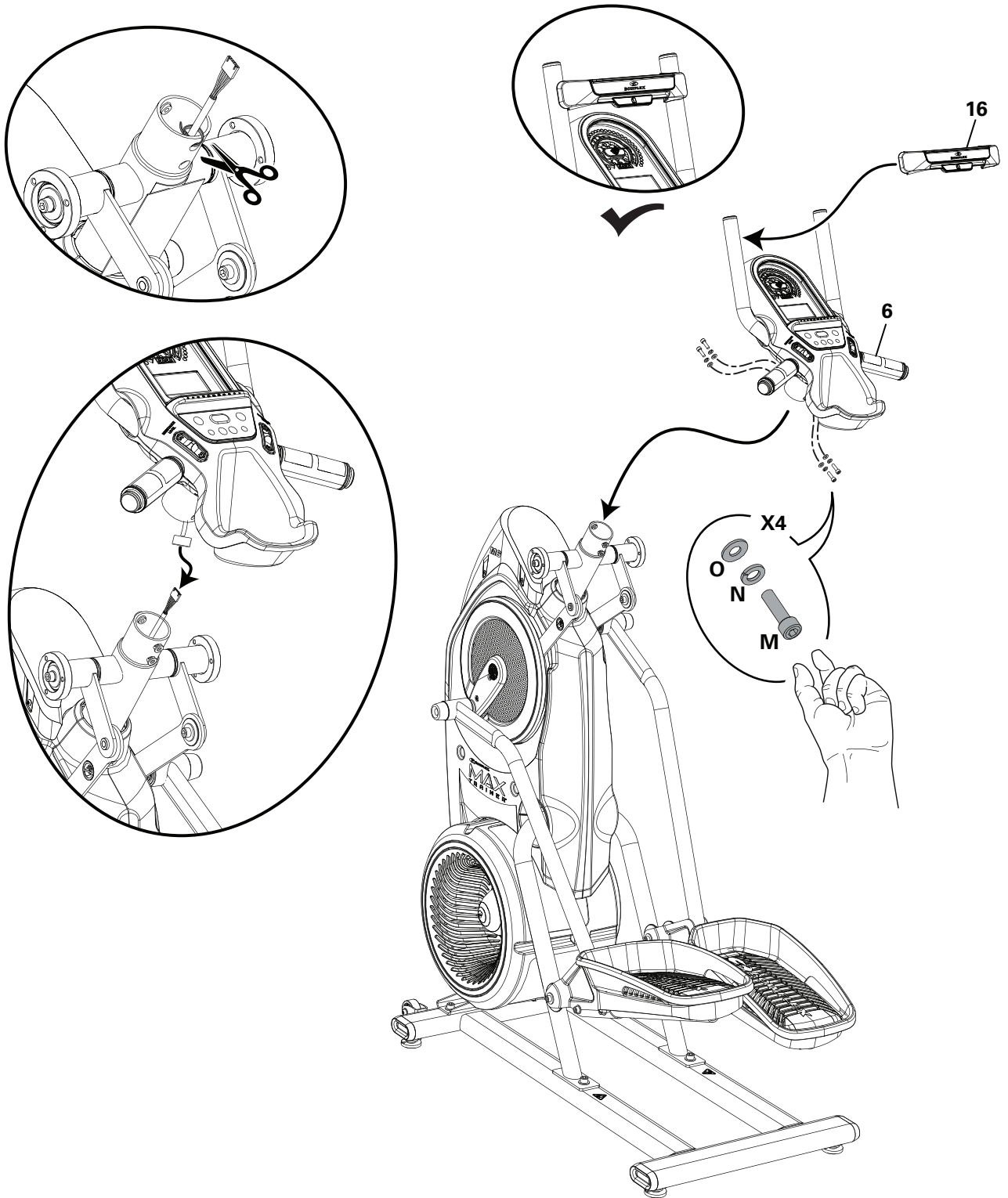

## 9. Attach the Upper Handlebars to Frame Assembly

**!** Be aware that the Pedals and the Upper Handlebars are connected and when either of these parts move the other does as well. Some components of the machine can be heavy or awkward. Use a second person when doing the assembly steps involving these parts. Do not do steps that involve heavy lifting or awkward movements on your own.

*NOTICE:* Be sure to attach the Upper Handlebars so that they are in the range of operation for the User.

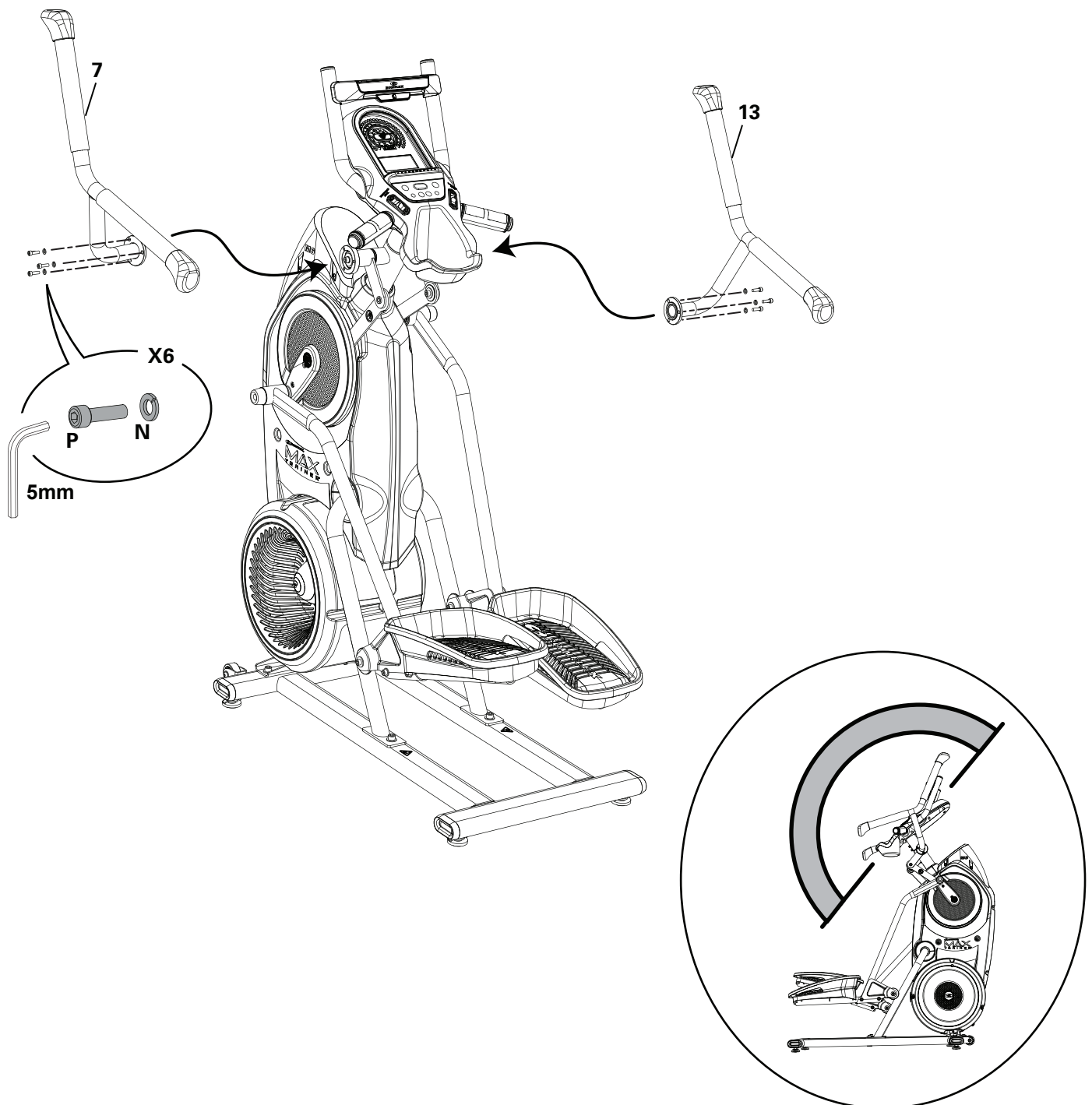



## 10. Connect the AC Adapter to the Frame Assembly

*NOTICE:* Be sure to use the appropriate AC Adapter plug for your region.

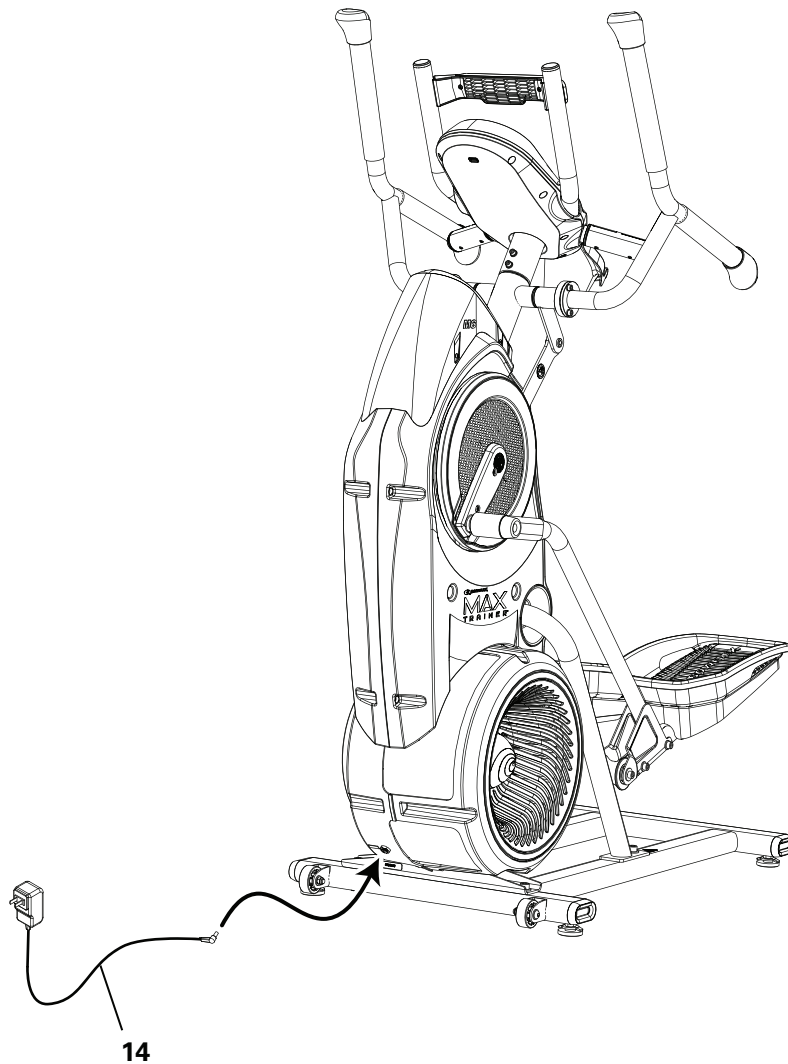

## 11. Final Inspection

Inspect your machine to ensure that all hardware is tight and components are properly assembled.

**Note:** Remove any protective covers from the face of the Console. Remove the plastic scratch guard strips from Rails.

Be sure to record the serial number in the field provided at the front of this manual.

**⚠ Do not use until the machine has been fully assembled and inspected for correct performance in accordance with the Owner's Manual.**

# Adjustments

## Moving the Machine

**!** The machine may be moved by one or more persons depending on their physical abilities and capacities. Make sure that you and others are all physically fit and able to move the machine safely.

1. Grasp the Aero Bars to carefully tilt the machine toward you onto the transport rollers. Be sure not to grab the Media Shelf.

**!** Be aware of the Handlebars and the weight of the machine before tilting the machine.

2. Push the machine into position.
3. Carefully lower the machine into position.

**NOTICE:** Be careful when you move the machine. All abrupt motions can affect the computer operation.

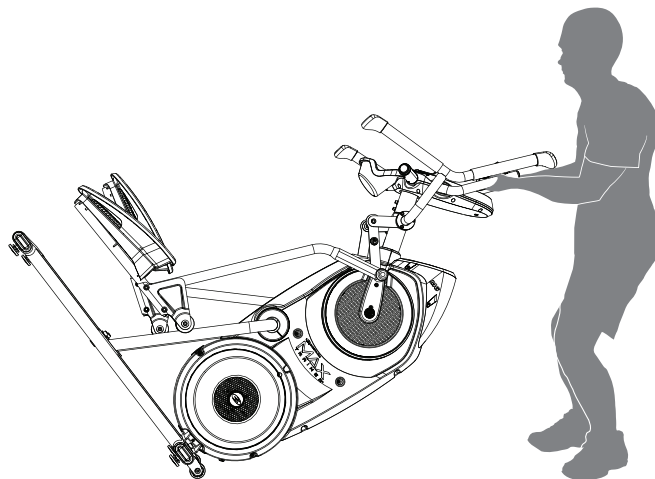

## Leveling the Machine

The machine needs to be leveled if your workout area is uneven or if the Rail Assembly is slightly off the floor. To adjust:

1. Place the machine in your workout area.
2. Loosen the locking nuts and adjust the levelers until they are evenly balanced in contact with the floor.

**!** Do not adjust the levelers to such a height that they detach or unscrew from the machine. Injury to you or damage to the machine can occur.

3. Tighten the locking nuts.

**!** Make sure the machine is level and stable before you exercise.

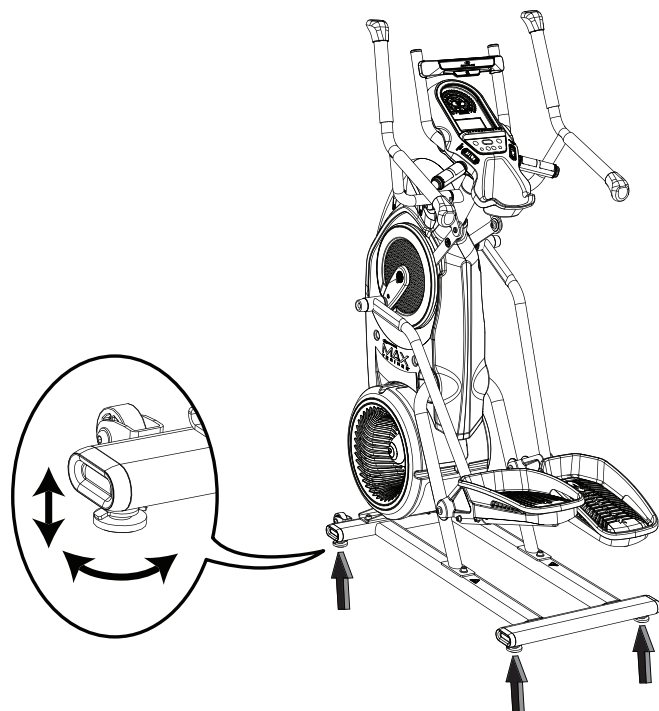

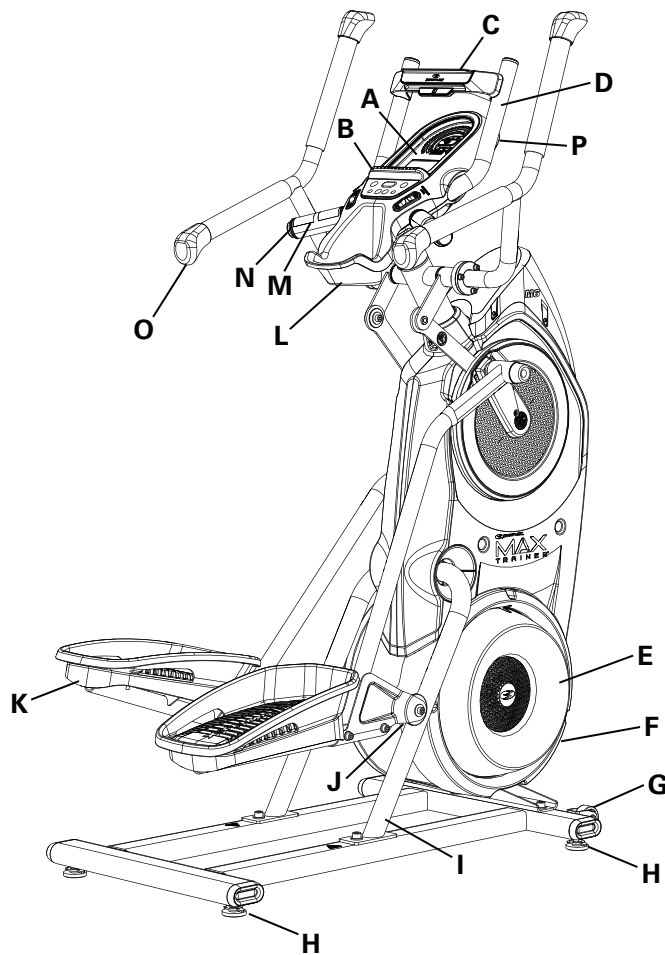

A	Console	J	Roller
B	Media Shelf	K	Pedal
C	Media Capture Bar	L	Water Bottle Holder / Tray
D	Aerobars	M	Contact Heart Rate (CHR) Sensors
E	Resistance Fan	N	Static Handlebars
F	Power Connector	O	Dynamic Handlebars
G	Transport Roller	P	USB Port
H	Leveler	Q	Bluetooth® Connectivity (not shown)
I	Rail Assembly		

## **⚠ WARNING**

Use the values calculated or measured by the machine's computer for reference purposes only. The heart rate displayed is an approximation and should be used for reference only. Over exercising may result in serious injury or death. If you feel faint stop exercising immediately.

## Console Features

### Burn Rate display

The Burn Rate display shows the level of calories being burned per minute (CAL/MIN). This rate is a function of Intensity, which is the current level of RPM (pedal speed) and resistance level (1-16). As either of those values increase, the Burn Rate will increase.

### Burn Rate Target LED range

The Burn Rate Target LED range is a workout coach based on the settings of the selected User Profile. A range of three LED's are activated during a workout. The first of the LEDs in the range is a suggested beginner level, with the higher LEDs being for a more advanced fitness user. The Intensity of the range is based on the Workout Profile Display.

**Note:** Be sure the User Profile is current for a more exact calorie burn rate and suggested target range.

**!** The Target LED Range is a suggested workout level, and should only be followed if your physical fitness level allows.

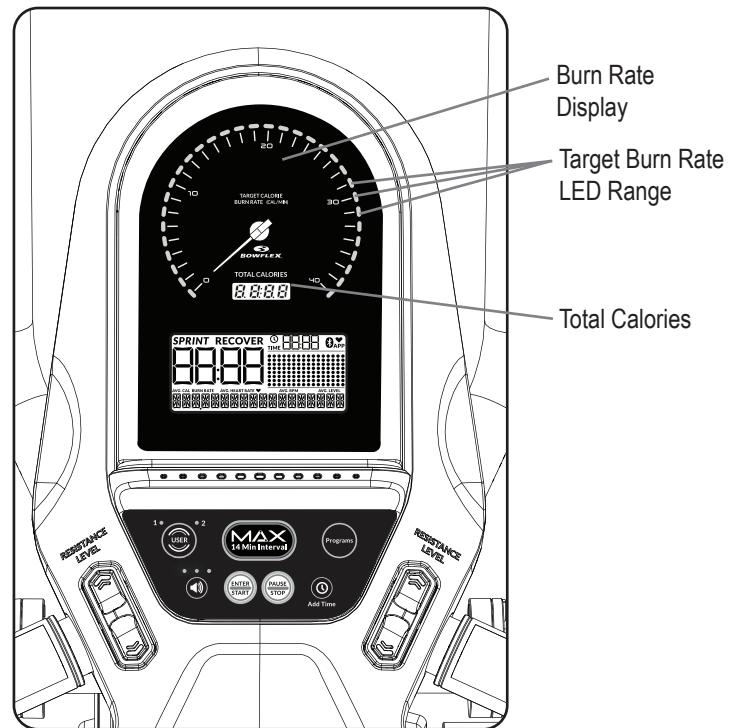

During an Interval workout, the SPRINT segment will be red LEDs, and the RECOVER segment will be green LEDs.

### Maximum Burn Rate LED marker

The Maximum Burn Rate LED marker is an orange LED that shows the highest rate of calorie burn achieved during the current workout.

### Total Calories display

The Total Calories display shows the estimated calories that have been burned during the workout. The maximum display is 9999.

### Active User display

The Active User display shows the selected user profile. A user profile is always selected.

**Note:** For more accurate calorie counts and Burn Rate Targets, be sure to edit your User Profile.

### User button

Push to select the desired User Profile, push and hold for 3 seconds to edit the selected User Profile.

### Volume button and indicator lights

The Volume button sets the sound level of the Console, and the indicator lights show the current setting; low (1 LED), medium (2 LEDs), high (3 LEDs), or off (no LEDs).

### MAX 14 Minute Interval button

Push to start the MAX 14 Minute Interval workout.

### PROGRAMS button

Push to select a workout program.

### ENTER/START button

Starts the selected Program workout, or resumes a paused workout. Push to accept the displayed value for an option.

### PAUSE/STOP button

Pauses an active workout, ends a paused workout, or goes to the Power-Up Mode screen.

### Add Time button

Increases the length of a workout by 2.5 minutes for non-Interval Workouts.

**Note:** Button is disabled during a Manual program.

### Resistance Level buttons

Adjusts the resistance level of the workout, selects a workout program, or changes a displayed value.

### Console Display

The console display shows the workout measurements and current options.

#### SPRINT

The high Intensity segment of an Interval workout. During an Interval workout, the active segment shifts between the SPRINT and RECOVER segments with an audible confirmation, counting the time down for the currently active segment.

#### RECOVER

The reduced workout segment of an Interval workout, counting down until the next SPRINT segment.

#### Interval/Workout Time display

The Interval/Workout Time display shows the time count for the active segment (for an interval workout) or completed time of workout.

#### Total Time display

The Total Time display shows the time for the total workout.

#### Bluetooth® Connected display

Display shows when a device is paired through a Bluetooth® connection.

#### App icon

Display shows when the Console is paired with the App.

**Note:** When the App is paired, the Console display will be de-activated.

#### Heart icon

Display shows when the Console is paired with a Bluetooth® Heart Rate Strap.

#### Workout Profile display

The Workout Profile display area shows the course profile of the program. Each column in the profile shows one workout segment. The higher the column, the higher the intensity of the workout.

During an interval Program, the Workout Profile shows the intensity of Burn Rate. During a resistance-based Program, the Workout Profile shows the level of resistance. The Console will adjust the Resistance Level during the workout.

The flashing column shows the currently active segment.

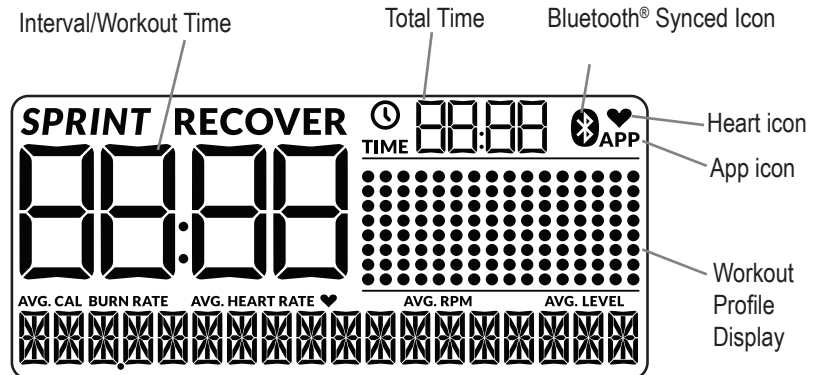

## Calorie Burn Rate

The Calorie Burn Rate display field shows the current rate at which calories are being burned per minute. The RPM and Resistance Level directly change this rate. The User Profile settings also affect the rate (User weight).

## Heart Rate

The Heart Rate display shows the heart rate in beats per minute (BPM) from the heart rate sensors. This value will not be shown if a heart rate signal is not detected.

 **Consult a physician before you start an exercise program. Stop exercising if you feel pain or tightness in your chest, become short of breath, or feel faint. Contact your doctor before you use the machine again. The heart rate displayed on the console is an approximation and should be used for reference only.**

## RPM

The RPM display field shows the machine revolutions per minute (pedal speed).

## Resistance Level

The Resistance Level display field shows the current Resistance Level (1-16). The higher the Resistance Level, the harder it will be to push the Pedals.

## Using your JRNY™ membership with your machine

If you have a JRNY™ membership\*, it can be accessed through your device when synced to the console of this Bowflex™ machine. With a JRNY™ membership, you receive guided workouts adapted to your capabilities, conveniently displayed on your device, and friendly virtual voice coaching designed to support you on your journey to long-term fitness success.

1. Download the app, named "Bowflex™ JRNY™". The app is available on the App Store and Google Play™.
2. Be sure that the Bluetooth® and Location Settings are active on your device. Activate them if necessary.
3. Open the app near the machine, and follow the instructions to sync your device to the machine.

If the app will not sync to the machine, restart your device and the machine. Repeat Step 3.

When notified that there is an update to your fitness machine, follow the prompts on the app. Place the device that is running the app on the Media Tray. The app will update the software on the machine with the latest version. Do not remove your device from the Media Tray until the update is complete. The machine will return to the Power-Up screen when the update is completed.

To break the connection from your device to the Console, simply close the app. If the connection does not break, push and hold down the USER button on the Console. This will break the connection and disconnect the device. If any buttons on the Console are pushed (besides the USER button), the Console will display, "Hold User Button to Disconnect".

\* A JRNY™ membership is required for the JRNY™ experience – see [www.bowflex.com/jrny](http://www.bowflex.com/jrny) for details. For United States and Canada customers, you can obtain a JRNY™ membership by calling 800-269-4126 or visiting [www.bowflex.com/jrny](http://www.bowflex.com/jrny). Where available (including the United States), you can also obtain a JRNY™ membership by downloading the JRNY™ app onto your phone or tablet and signing up within the downloaded app. JRNY™ memberships may not be available in all countries.



## Workout with Other Apps

This fitness machine has integrated Bluetooth® connectivity which allows it to work with a number of digital partners. For our latest list of supported partners, please visit: [bowflex.com/max-trainer-app.html](http://bowflex.com/max-trainer-app.html)

## USB Charging

If a USB Device is attached to the USB Port, the Port will attempt to charge the Device. The power supplied from the USB Port may not be enough to operate the Device and charge it at the same time.

## Secure Your Device for a Workout

This fitness machine is equipped with a Media Capture Bar that secures a variety of sized devices to the Media Tray. The Media Capture Bar has two tabs to use depending on the size of your device. The upper, or large device, tab is used for devices such as a tablet or larger phone. The lower, or small device, tab is used for smaller devices such as a phone or mini tablet.

To secure your device, place the lower edge of your device in the Media Tray. Then shift the Media Capture Bar downward until your device is captured securely in the appropriate tab and the Media Tray.

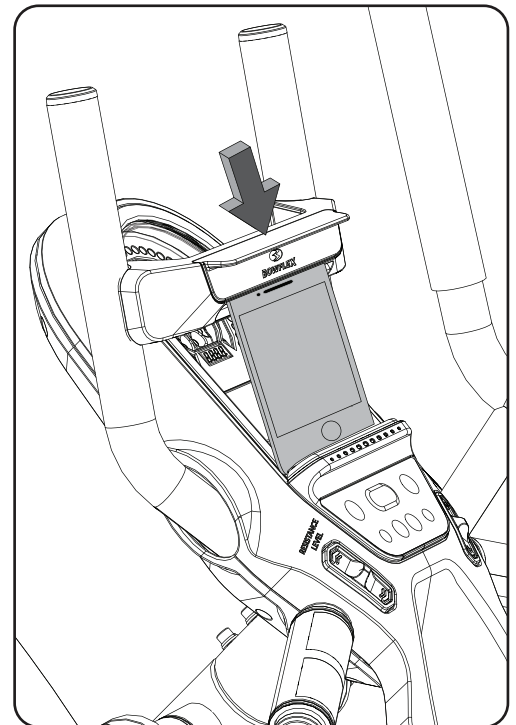
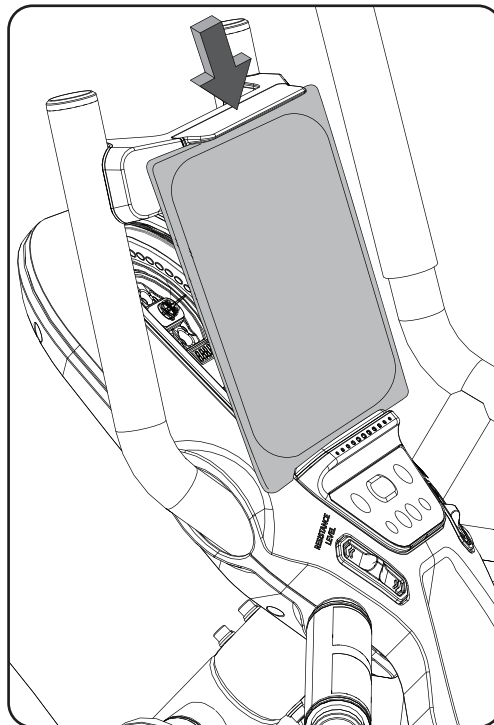
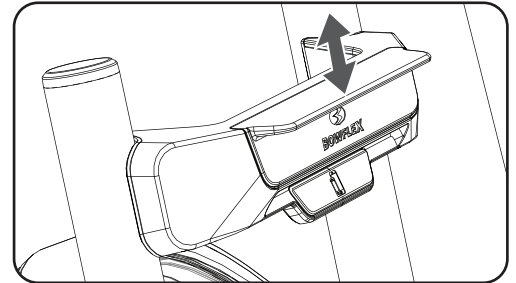

**Note:** Smaller devices that are placed on their side may not be able to be secured. Rotate the device and secure it in the upright position.

## Contact Heart Rate Sensors

Contact Heart Rate (CHR) sensors send your heart rate signals to the Console. The CHR sensors are the stainless steel parts of the Handlebars. To use, put your hands comfortably around the sensors. Be sure that your hands touch both the top and the bottom of the sensors. Hold firm, but not too tight or loose. Both hands must make contact with the sensors for the Console to detect a pulse. After the Console detects four stable pulse signals, your initial pulse rate will be shown.

Once the Console has your initial heart rate, do not move or shift your hands for 10 to 15 seconds. The Console will now validate the heart rate. Many factors influence the ability of the sensors to detect your heart rate signal:

- Movement of the upper body muscles (including arms) produces an electrical signal (muscle artifact) that can interfere with pulse detection. Slight hand movement while in contact with the sensors can also produce interference.
- Calluses and hand lotion may act as an insulating layer to reduce the signal strength.
- Some Electrocardiogram (EKG) signals generated by individuals are not strong enough to be detected by the sensors.
- The proximity of other electronic machines can generate interference.

**!** Use the values calculated or measured by the machine's computer for reference purposes only.

### Bluetooth® Heart Rate Strap (not supplied)

Your fitness machine is equipped to be able to receive a signal from a Bluetooth® Heart Rate Strap. When connected, the Console will display the Bluetooth® Connected icon.

**!** If you have a pacemaker or other implanted electronic device, consult your doctor before using a Bluetooth® strap or other Bluetooth® heart rate monitor.

1. Put on your Bluetooth® Heart Rate Strap.
2. If equipped, push the On/Off button on your strap to activate it. The Console actively searches for any devices in the area, and should connect to the strap when in range.
3. The Bluetooth® Connected icon will activate when connected. You are ready to workout.

At the end of your workout, push the On/Off button (if equipped) to disconnect your Heart Rate Strap from the Console.

### Heart Rate Calculations

Your maximum heart rate usually decreases from 220 Beats Per Minute (BPM) in childhood to approximately 160 BPM by age 60. This fall in heart rate is usually linear, decreasing by approximately one BPM for each year. There is no indication that training influences the decrease in maximum heart rate. Individuals of the same age could have different maximum heart rates. It is more accurate to find this value by completing a stress test than by using an age related formula.

Your at-rest heart rate is influenced by endurance training. The typical adult has an at-rest heart rate of approximately 72 BPM, whereas highly trained runners may have readings of 40 BPM or lower.

The Heart Rate table is an estimate of what Heart Rate Zone (HRZ) is effective to burn fat and improve your cardiovascular system. Physical conditions vary, therefore your individual HRZ could be several beats higher or lower than what is shown.

The most efficient procedure to burn fat during exercise is to start at a slow pace and gradually increase your intensity until your heart rate reaches between 60 – 85% of your maximum heart rate. Continue at that pace, keeping your heart rate in that target zone for over 20 minutes. The longer you maintain your target heart rate, the more fat your body will burn.

The graph is a brief guideline, describing the generally suggested target heart rates based on age. As noted above, your optimal target rate may be higher or lower. Consult your physician for your individual target heart rate zone.

**FAT-BURNING TARGET HEART RATE**

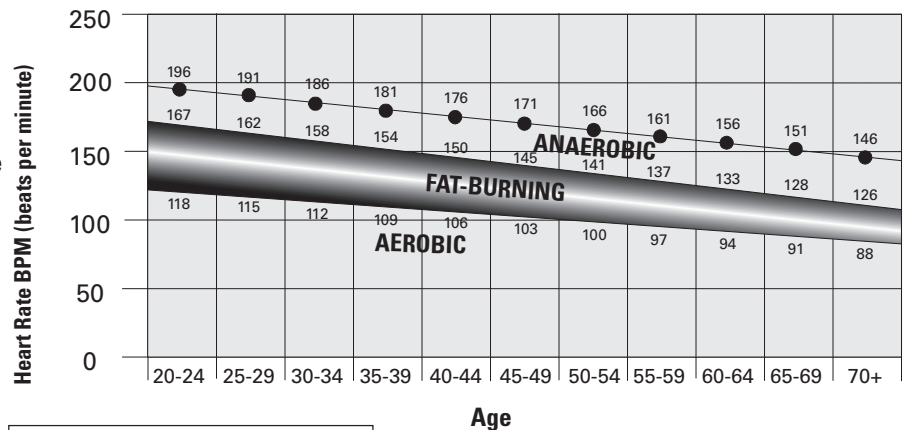

**Note:** As with all exercises and fitness regimens, always use your best judgment when you increase your exercise time or intensity.

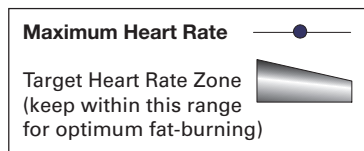

## **Fitness Basics**

### **Frequency**

To maintain good health, lose weight and improve your cardiovascular endurance, try and use the Bowflex™ Max Trainer™ cardio machine a minimum of 3 times per week, around 14 minutes each day.

If you are new to exercise (or returning to a regular exercise program), and you are unable to comfortably complete 14 minutes of continuous exercise at one time, just do 5 – 10 minutes, and gradually increase your workout time until you can reach a 14 minute total.

If your schedule is busy, and you are unable to fit 14 minutes of continuous exercise into your day, try accumulating 14 minutes by doing multiple shorter workouts on the same day. For example, 7 minutes in the morning and 7 minutes in the evening. This may be a great way to start your cardio training if you are new to vigorous activity.

For best results, combine your Bowflex™ Max Trainer™ cardio machine workouts with a strength training program using a Bowflex™ home gym or Bowflex™ SelectTech™ dumbbells, and follow the Bowflex™ Body Weight Loss Guide included in this manual.

### **Consistency**

Busy work schedules, family obligations and daily chores can make it difficult to fit regular exercise into your life. Try these tips to increase your chances of success:

Schedule your workouts the same way you schedule meetings or appointments. Select specific days and times each week, and try not to change your workout times.

Make a commitment to a family member, friend or spouse, and encourage each other to stay on track each week. Leave messages with friendly reminders to be consistent, and keep each other accountable.

Make your workouts more interesting by alternating between steady state (single-speed) workouts and interval training (varied speed) workouts. The Bowflex™ Max Trainer™ cardio machine is even more fun when you add this kind of variety.

### **Apparel**

It is important to wear appropriate, safe and comfortable footwear and clothing when using the Bowflex™ Max Trainer™ cardio machine, including:

- Rubber-soled athletic walking or running shoes.
- Exercise clothing that allows you to move freely, and keep comfortably cool.
- Athletic support that provides stability and comfort.
- Exercise friendly water bottle for constant hydration.

## Warm-Up\*

Before you use your Bowflex™ Max Trainer™ cardio machine, consider doing these dynamic warm-up stretches, which will help prepare your body for the workout:

---

### Dynamic Knee Hug

Stand with the feet together. Bring one knee forward and up toward the chest. Place the hands around the shin and pull the knee into the chest. Release the stretch by putting the foot on the floor. Each repetition of the sequence should take 1 to 3 seconds. Repeat as a continuous, controlled, fluid sequence 10 or 20 times. Repeat the stretch with the other leg.

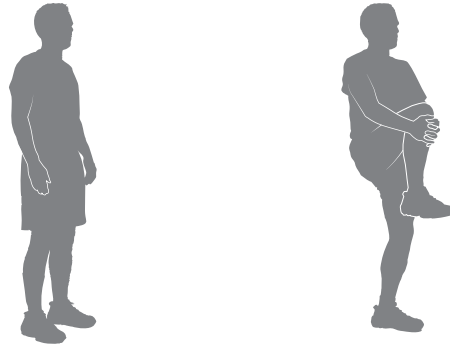

---

### Dynamic Knee Bend

Stand with the feet together. Hold onto a wall for balance with one hand, if necessary. Raise the heel of one foot toward the gluteals. Release the stretch by putting the foot on the floor. Each repetition of the sequence should take 1 to 3 seconds. Repeat as a continuous, controlled, fluid sequence 10 or 20 times. Repeat the stretch with the other leg.

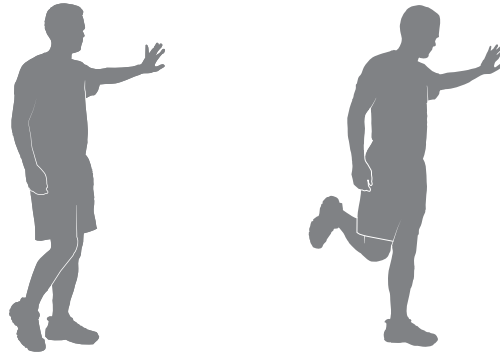

---

### Dynamic Knee Kick

Stand tall and hold one leg up with the hands at hip height, keeping the knee bent. Hold onto a wall for balance with one hand, if necessary. Straighten the knee as far as comfortably possible. Release the stretch by bending the knee. Each repetition of the sequence should take 1 to 3 seconds. Repeat as a continuous, controlled, fluid sequence 10 or 20 times. Repeat the stretch with the other leg.

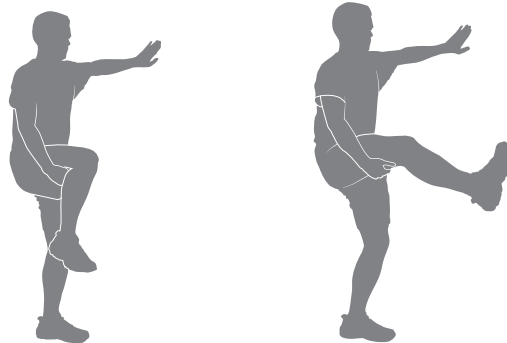

---

### Dynamic Twist

Stand with the feet shoulder-width apart. Bend the elbows; hold the arms out to the sides. Twist the upper body to one side and then the other side as far as comfortably possible. Each repetition of the sequence should take 1 to 3 seconds. Repeat as a continuous, controlled, fluid sequence 10 or 20 times.

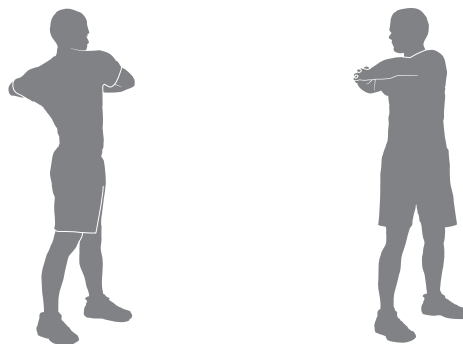

---

\* Source: Jay Blahnik's Full-Body Flexibility, Second Edition, 2010. HumanKinetics.com.

### Dynamic Bent Knee Heel Press

Stand with one foot forward and one foot back, hip-width apart and feet facing forward. Hold onto a wall for balance with one hand, if necessary. Bend both knees putting weight on the back heel. Release the stretch by returning to the start position. Each repetition of the sequence should take 1 to 3 seconds. Repeat as a continuous, controlled, fluid sequence 10 or 20 times. Repeat the stretch with the other leg. Touch a wall or hold onto something for balance, if necessary.

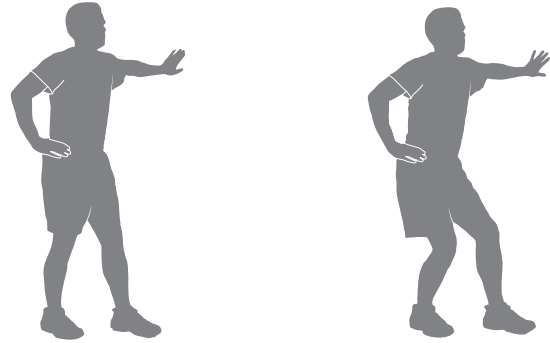

### Dynamic Side Reach

Stand with the feet apart, the knees slightly bent and the arms at the sides of the body. Reach with one hand above the head and lean over to the opposite side. Release the stretch by returning to the start position. Then reach with the other hand to the opposite side. Use the other arm to support the body weight on the thigh, if necessary. Each repetition of the sequence should take 1 to 3 seconds. Repeat as a continuous, controlled, fluid sequence 10 or 20 times.

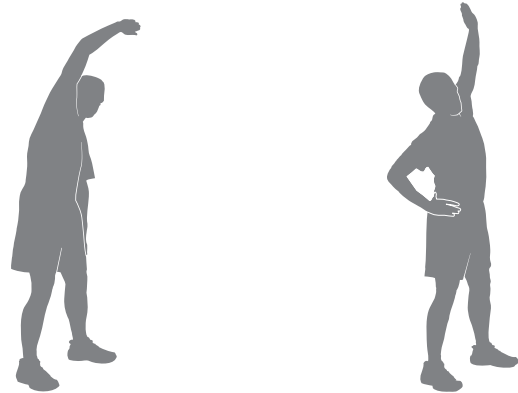

## Workouts

Follow these guidelines to ease yourself into a weekly exercise regimen. Use your judgment and/or the advice of your physician or health care professional to find the intensity and level of your workouts.

**⚠️ Consult a physician before you start an exercise program. Stop exercising if you feel pain or tightness in your chest, become short of breath, or feel faint. Contact your doctor before you use the machine again. Use the values calculated or measured by the machine's computer for reference purposes only. The heart rate displayed on the console is an approximation and should be used for reference only.**

Steady State and Interval Training are 2 types of workouts you can do on your Bowflex™ Max Trainer™ cardio machine:

### Steady State workouts

A Steady State workout involves slowly increasing your workout speed to a challenging, but comfortable, speed you can hold for most of your workout. Getting your Heart Rate up into the Fat-Burning, Heart Zone zone for an entire workout would be a great Steady State workout. For example, holding a 6 calories per minute Burn Rate pace for the entire workout, except during the warm-up and cool-down. Steady State workouts help you build exercise confidence, stamina and endurance, and are essential to a well-rounded cardiovascular training program.

### Interval Training workouts

An Interval Training workout involves adjusting your workout intensity for specific lengths of time to raise and lower your breathing rate, heart rate and calorie burn. This form of workout allows you to burn more calories than a standard workout in a shorter period of time. Using the Calorie Burn Rate display, you can adjust the intensity of your workout quickly to achieve your goals.

The Bowflex™ Max Trainer™ cardio machine combines 8 “SPRINT” and 8 “RECOVER” segments to create an Interval workout. During an “SPRINT” segment, push yourself to a level of high calorie burn that can be repeated for the 8 segments. Then during the “RECOVER” segments, allow yourself to decrease the intensity and prepare for the next “SPRINT” segment. These extreme changes in intensity, along with pushing your body toward exhaustion, is where the maximum benefits are gained from Interval Training workouts.

Interval Training workouts provide variety, maximize calorie burn and improve fitness.

The Bowflex™ Max Trainer™ cardio machine is designed to be low impact, and both Steady State and Interval Training workouts should feel more comfortable than running outside on a hard surface or a treadmill.

### After Burn Rate

At the end of an intense Interval Training workout, your body will actually need to expend additional energy to replenish your body's reserves. This additional amount of energy that your body will be using is the After Burn Rate, or EPOC (Excess Post-exercise Oxygen Consumption). The level of this additional energy requirement for your body is directly related to many factors. Some factors are your physical fitness level, intensity level of the interval training workout, length of oxygen deprivation during the workout, and physical demands during the recovery phase.

In summary, your body may be burning more calories after an intense Max Interval workout





### Side Lying Knee Bend

Lie on the floor on one side of the body and rest the head on the lower arm. Bend the top knee and hold the ankle with the same-side hand, then pull the heel toward the gluteals. Hold the stretch for 10 to 30 seconds. Lie on the other side and repeat the stretch with the other leg. Remember to hold the knees close together.

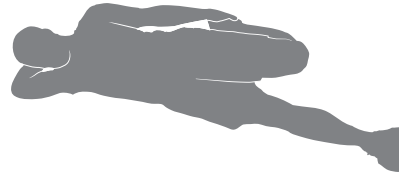

### Lying Figure Four

Lie on the floor face up with the legs bent. Place one foot across the thigh of the opposite leg in the figure four position. Reach for the leg on the floor and pull it toward the chest. Hold the stretch for 10 to 30 seconds. Repeat the stretch with the other leg. Keep the head on the floor.

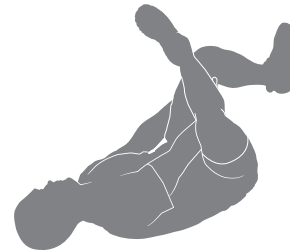

### Seated Twist

Sit on the floor and extend the legs straight out in front of the body with the knees slightly bent. Place one hand on the floor behind the body and the other hand across the thigh. Twist the upper body as far as comfortably possible to one side. Hold the stretch for 10 to 30 seconds. Repeat the stretch on the other side.

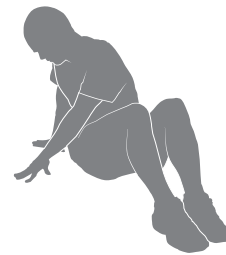

### Seated Figure Four

Sit on the floor and extend one leg straight out in front of the body. Place the foot of the other leg across the thigh in the figure four position. Move the chest toward the legs, pivoting at the hip. Hold the stretch for 10 to 30 seconds. Repeat on the other leg. Use the arms to support the back.



### Dynamic Heel Drop

Place the ball of one foot on the edge of a step or staircase. Place the other foot slightly in front. Hold onto a wall for balance with one hand, if necessary. Lower the heel of the back foot as far as comfortably possible, keeping the knee straight. Release the stretch by lifting the heel as high as comfortably possible. Each repetition of the sequence should take 1 to 3 seconds. Repeat as a continuous, controlled, fluid sequence 10 or 20 times. Repeat the stretch with the other leg.

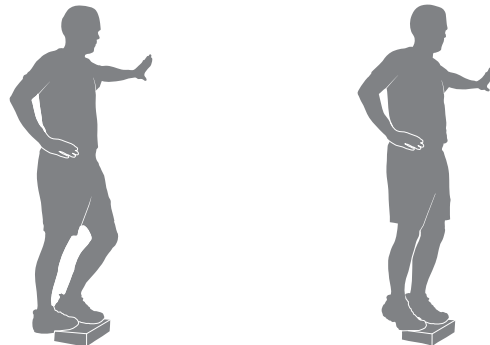

\* Source: Jay Blahnik's Full-Body Flexibility, Second Edition, 2010. HumanKinetics.com.

## How Often Should You Exercise

**!** Consult a physician before you start an exercise program. Stop exercising if you feel pain or tightness in your chest, become short of breath, or feel faint. Contact your doctor before you use the machine again. Use the values calculated or measured by the machine's computer for reference purposes only. The heart rate displayed on the console is an approximation and should be used for reference only.

- 3 times a week for about 14 minutes each day.
- Schedule workouts in advance and try to follow the schedule.

**Note:** If you are new to exercise (or returning to a regular exercise program), and you are unable to comfortably complete 14 minutes of continuous exercise at one time, just do 5 – 10 minutes, and gradually increase your workout time until you can reach a 14 minute total.

## Intensity of Workout

To increase the intensity of your workout:

- Push yourself to increase the number of Pedal revolutions per minute.
- Place your feet further out toward the rear of the Pedals.
- Increase the Intensity Level and keep your RPM consistent, or increase it as well.
- Use your upper and lower body at different levels.
- Shift your grip location on the Handlebars to work out other parts of your upper body.

## Hand Placement (Grip Selection)

This fitness machine is equipped with multiple Handlebars which allow for a variety of different types of workouts. As you progress on your fitness routine, shift your hand placement to target different muscle groups.

**!** Exercise on this machine requires coordination and balance. Be sure to anticipate that changes in speed and resistance level can occur during workouts, and be attentive in order to avoid loss of balance and possible injury.

The Dynamic Handlebars allow for a variety of upper body workouts. When starting out, place your hands where it feels most comfortable and stable on the Dynamic Handlebars.

The Static Handlebars below the Console Assembly can also be used to add stability during a workout, as well as provide your heart rate.

For a workout focused on legs, lean in until your forearms run along the Aerobars with your hands upward. When leaning in, be aware of the motion of the Dynamic Handlebars during the workout.

## Mounting and Dismounting Your Machine

**!** Care should be used when mounting or dismounting the machine.

Be aware that the Pedals and the Handlebars are connected and when either of these parts move the other does as well. In order to avoid possible serious injury, grasp the Static Handlebars to steady yourself.

Be sure there is nothing under the Pedals or in the Air Resistance Fan before moving anything on the machine.

To mount your fitness machine:

1. Move the Pedals until the one nearest to you is in the lowest position.
2. Grasp the Static Handlebars under the Console Assembly.
3. Steadying yourself with the Static Handlebars, step up onto the lowest Pedal and place your other foot onto the opposite Pedal.

**Note:** "Bottomed out" is when the User is unable to start a workout because the Pedals will not move. If this occurs, safely grasp the Static Handlebars and apply your weight to the heel of the higher foot. While still grasping the Static Handlebar, lean back slightly applying more weight onto the heel. Once the Pedals begin to move, resume your intended workout.

To dismount your fitness machine:

1. Move the Pedal you want to dismount from to the highest position, and bring the machine to a complete stop.



**This machine is not equipped with a free-wheel. Pedal speed should be reduced in a controlled manner.**

2. Grasp the Static Handlebars under the Console to steady yourself.
3. With your weight on the lowest foot, swing the upper foot off the machine and down onto the floor.
4. Step off of the machine and release your grip from the Static Handlebars.

## Getting Started

1. Place the fitness machine in your workout area.



**Place the machine on a clean, hard, level surface, free from unwanted material or other objects that may hamper your ability to move freely. A rubber mat can be used below the machine to prevent the release of static electricity and protect your flooring.**

**The machine can be moved by one or more persons. Make sure that your own physical strength is capable of safely moving the machine.**

2. Examine for any objects below the Pedals and in the Air Resistance Fan. Be sure it is clear.
3. Connect the power cord to the machine and into a grounded AC Wall Outlet.
4. If you use a Heart Rate Monitor, follow the Heart Rate Monitor directions.
5. To mount the machine, move the Pedals until the one nearest you is in the lowest position.



**Care should be used when mounting or dismounting the machine.**

**Be aware that the Pedals and the Handlebars are connected and when either of these parts move the other does as well. In order to avoid possible serious injury, grasp the Static Handlebars to steady yourself.**

6. Grasp the Static Handlebars under the Console Button Assembly.
7. Steadying yourself with the Static Handlebars, step up onto the lowest Pedal and place your other foot onto the opposite Pedal.
8. Push the USER button to select the desired User Profile.
9. Push and hold the USER button to edit the User Profile.
10. The Console will display the Units value. Use the Increase/Decrease buttons to adjust the Units value, and push the ENTER/START button to set the value.

11. The Console will display the Weight value for the User Profile. Use the Increase and Decrease buttons to adjust the weight value, and push the ENTER/START button to set the value.

**Note:** Be sure to program your User Profile (see the Edit a User Profile section) before starting a workout. The suggested Target Burn Rates are based on your User Profile settings.

12. Push the Max 14 Minute Interval button to begin a Quick Start workout. Allow time to become familiar with how your Bowflex™ Max Trainer™ machine operates and responds to adjustments of Resistance Level and rpm.

**Note:** When operating the Bowflex™ Max Trainer™ machine, be sure the Legs are moving in the direction as shown on the Crank Cover.

## Power-Up / Idle Mode ( GET READY screen )

The Console will enter Power-Up / Idle Mode if it is plugged into a power source, any button is pushed, or if it receives a signal from the RPM sensor as a result of pedaling the machine.

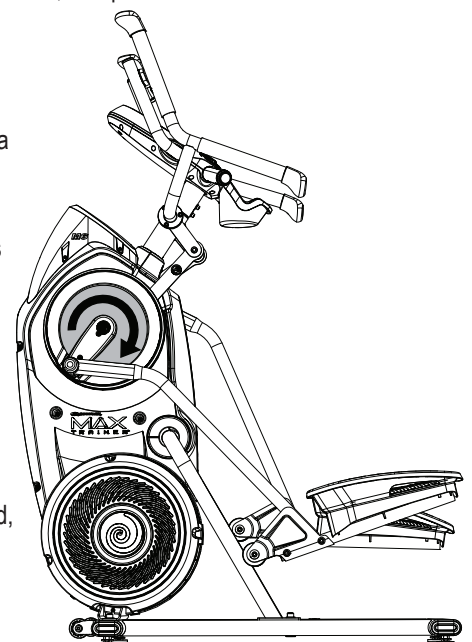

## Auto Shut-Off (Sleep Mode)

If the Console does not receive any input in approximately 5 minutes, it will automatically shut off. The LCD display is off while in Sleep Mode.

**Note:** The Console does not have an On/Off switch.

## Warm Up Mode

A Warm Up mode is available from the Power-Up screen. To begin, just start using the machine until ready for a workout. During Warm Up, the User Profile and the workout can be selected. The Console will only display the current Burn Rate during Warm-Up.

**Note:** The workout values from a Warm Up period are not added to the workout or saved for export to the App.

## MAX 14 MINUTE INTERVAL Program

The MAX Interval Workout Program is a workout that alternates from intense bursts of output ( "SPRINT" ), to a slower paced, 'catch your breath' time period ( "RECOVER" ), both of which are repeated over eight cycles. The Workout Profile Display shows the Burn Rate Target for the MAX 14 Minute Interval program.

1. Stand on the machine.
2. Push the USER button to select your User Profile.

**Note:** During the workout, the Console will show the Target LED Range based on the selected User Profile settings.

3. Push the MAX 14 Minute Interval button.
4. The workout will begin with an audible countdown as the Burn Rate display needle sweeps across the display and then settles on the current Burn Rate. The Target Burn Rate LED's will also activate and sweep up to the recommended Burn Rate.

The first Interval segment is a "SPRINT" segment that lasts for a shorter period of time. Safely push yourself to get the Burn Rate display into the Burn Rate Target (red LED's) and keep it in the range until the time reaches 00:00.

**Note:** The Burn Rate Target (LED) Range is provided only as a suggested target. The three LED range provides a lesser target, and allows a User to progress to the higher LED's in the range as their fitness level increases.

During the last 3 seconds of the "SPRINT" segment, the Console will begin an audible countdown.

5. As the time reaches "00:00", the Console will make the third audible confirmation and the next segment of the workout, the "RECOVER" segment, will begin.

The Target LED Range will shift from red to green and sweep to a reduced Burn Rate. During the RECOVER segment, continue to work out but at a lower Intensity.

During the last 3 seconds of the "RECOVER" segment, the Console will begin an audible countdown.

6. As the time reaches "00:00", the Console will make an audible confirmation and shift to the next "SPRINT" segment. This is the completion of the first Interval.

The shift from "SPRINT" to "RECOVER" segments will repeat for a total of 8 cycles over the workout.

7. When the last "RECOVER" segment is completed, the Console will display "WORKOUT COMPLETE", and then show the workout results. The Console will display the time for each "SPRINT" segment, along with TOTAL TIME. If there is no input for 5 minutes, the Console will automatically go into Sleep Mode.

**Note:** If an Interval workout is ended before all 16 segments have been completed, the Console will only show the last segment completed on the Program Profile.

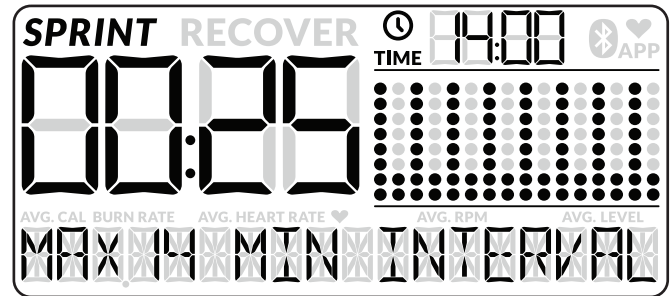

## Edit a User Profile

For a more accurate calorie count and Target Calorie Burn, a User Profile should be customized to the User.

1. Push USER button to select your User Profile (User 1- 2).

2. Push and hold the USER button for 3 seconds to begin the Edit User mode.
3. The Console will display the DISPLAY UNITS prompt ( "LBS" or "KG"). Use the Resistance Level/Increase or Decrease buttons to adjust the value, and push ENTER/START to set the value.
4. The Console will display the WEIGHT prompt with the current weight value. Use the Resistance Level/Increase or Decrease buttons to adjust the value, and push ENTER/START to set the value. Push and hold down the Resistance Level/Increase or Decrease buttons to change the value quickly.

**⚠ Maximum user weight limit: 136 kg (300 lbs.). Do not use if you are over this weight.**

5. The Console will display the ENABLE BLE HR prompt with the current value ( "NO" or "YES"). If necessary, use the Resistance Level/Increase or Decrease buttons to adjust the value. Push ENTER/START to accept the value.
6. The Console will display the ERASE WORKOUTS prompt with the current value ( "NO" or "YES"). If necessary, use the Resistance Level/Increase or Decrease buttons to adjust the value. Push ENTER/START to accept the value.
7. The User Profile review is complete, and the Console will display the GET READY screen.

To exit the Edit User mode, push the PAUSE/STOP button. The current values will be saved to the User Profile.

## Workout Programs

### Max 14 Minute Interval

The Max 14 Minute Interval Program alternates from intense bursts of output ( "SPRINT" ), to a slower paced, 'catch your breath' time period ( "RECOVER" ), both of which are repeated over the number of intervals. The Workout Profile display shows the Burn Rate Target for the Interval program. For additional details, reference the "MAX 14 MINUTE INTERVAL Program" section of the manual.

Max 14 Minute Interval (8 Intervals)

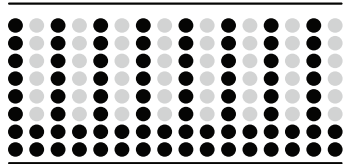

### Calorie Burn, Fat Burn, and Stairs Programs

The Calorie Burn, Fat Burn, and Stairs Programs show the course profile of the program in Resistance Levels. Each column in the profile shows one workout segment. The higher the column, the higher the resistance level. Each workout is for 15 minutes.

The flashing column shows the currently active segment. The Console will adjust the Resistance Level to follow the Workout Profile Display.

**Note:** If the Resistance Level is adjusted during a workout, the profile of the Workout Program will change.

Calorie Burn (4 segments)

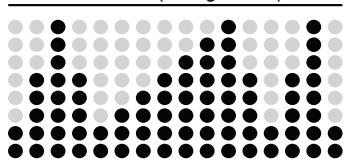

Fat Burn (4 segments)

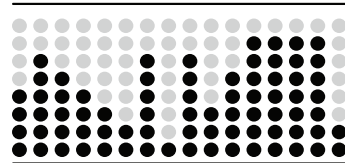

### Stairs (4 segments)

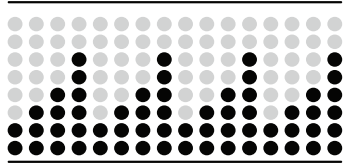

### Manual

The Manual workout program is an open-ended workout that tracks the total workout time. During a Manual workout, the Workout Profile Display shows the Resistance Level.

**Note:** Because of the open-ended design of the Manual workout, the Add Time button is disabled.

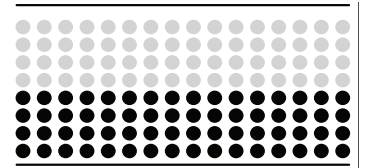

To start a Workout Program:

1. Stand on the machine.
2. Push the PROGRAMS button to select the desired Workout Program.
3. Push the ENTER/START button to begin the selected Workout Program.

### Paused / Results Mode

To Pause a workout:

1. Stop pedaling and push the PAUSE/STOP button to pause your workout.

When paused, the Console display will show "WORKOUT PAUSED".

**Note:** The Console will automatically pause if there is no RPM signal for 5 seconds.

2. To continue your workout, push ENTER/START or start pedaling.

To end the workout, push the PAUSE/STOP button. The Console will display "WORKOUT COMPLETE", save the workout, and then display the workout result values (Total Calories, Total Time, Average Calorie Burn Rate, Average Heart Rate, Average RPM, and Average Resistance Level).

If there is no input to the Console for 5 minutes, it automatically goes to the Power-Up / Idle Mode.



# Console Setup Mode

The Console Setup Mode lets you view maintenance statistics (Total Run Hours and Software Version) or fully reset the Console.

1. Push and hold down the Volume and PAUSE/STOP buttons for 3 seconds while in the Power-Up Mode to go into the Console Setup Mode.  
**Note:** Push PAUSE/STOP to exit the Console Setup Mode and return to the Power-Up Mode screen.
2. The Console display shows the TOTAL HOURS the machine has operated.
3. Push the ENTER/START button for the next prompt.
4. The Console display shows the Firmware Version prompt.
5. Push the ENTER/START button for the next prompt.
6. The Console display shows the BLE VERSION prompt.
7. Push the ENTER/START button for the next prompt.
8. The Console displays the DISCONNECT BLEHR prompt.  
**Note:** If you want to disconnect the Bluetooth® transmitter, push the Increase/Decrease buttons to select the “DISCONNECT BLEHR YES” option, and push ENTER/START. The Console will exit the Machine Settings Mode and return to the Power-Up Mode screen.
9. The Console displays the VIEW ERROR LOG NO option. This option is for Service Technicians use only.
10. Push the ENTER/START button for the next prompt.
11. The Console displays the RESET CONSOLE NO prompt.  
**Note:** If you want to reset the Console to factory settings, push the Increase/Decrease buttons to select the “RESET CONSOLE YES” option, and push ENTER/START. Unplug the AC Adapter from the machine when the Console displays the “POWER CYCLE NOW” prompt.
12. Push the PAUSE/STOP button to exit the Console Setup Mode.  
The Console will display the Power-Up Mode screen.

Read all maintenance instructions fully before you start any repair work. In some conditions, an assistant is required to do the necessary tasks.

 **Equipment must be regularly examined for damage and repairs. The owner is responsible to make sure that regular maintenance is done. Worn or damaged components must be repaired or replaced immediately. Only manufacturer supplied components can be used to maintain and repair the equipment.**

If at any time the Warning labels become loose, unreadable or dislodged, replace the labels. If purchased in US/Canada, contact Customer Service for replacement labels. If purchased outside US/Canada, contact your local distributor for them.

To reduce the risk of electrical shock or usage of the equipment, always unplug the power cord from the wall outlet and the machine and wait 5 minutes before cleaning, maintaining or repairing the machine. Place the power cord in a secure location.

**Daily:** Before each use, examine the exercise machine for loose, broken, damaged, or worn parts. Do not use if found in this condition. Repair or replace all parts at the first sign of wear or damage. After each workout, use a damp cloth to wipe your machine and Console free of sweat.

Note: Avoid excessive moisture on the Console.

**Weekly:** Check for smooth roller operation. Wipe the machine to remove dust, dirt, or grime. Clean the rails and surface of the rollers with a damp cloth.

Apply silicone lubricant to a dry cloth and wipe the rails to eliminate roller noise.

 **Silicone lubricant is not intended for human consumption. Keep out of reach of children. Store in a safe place.**

**Note:** Do not use petroleum based products.

**Monthly or after 20 hours:** Make sure all bolts and screws are tight. Tighten as necessary.

**NOTICE:** If necessary, only use a mild dish soap with a soft cloth to clean the Console. Do not clean with a petroleum based solvent, automotive cleaner, or any product that contains ammonia. Do not clean the Console in direct sunlight or at high temperatures. Be sure to keep the Console free of moisture.

# Maintenance Parts

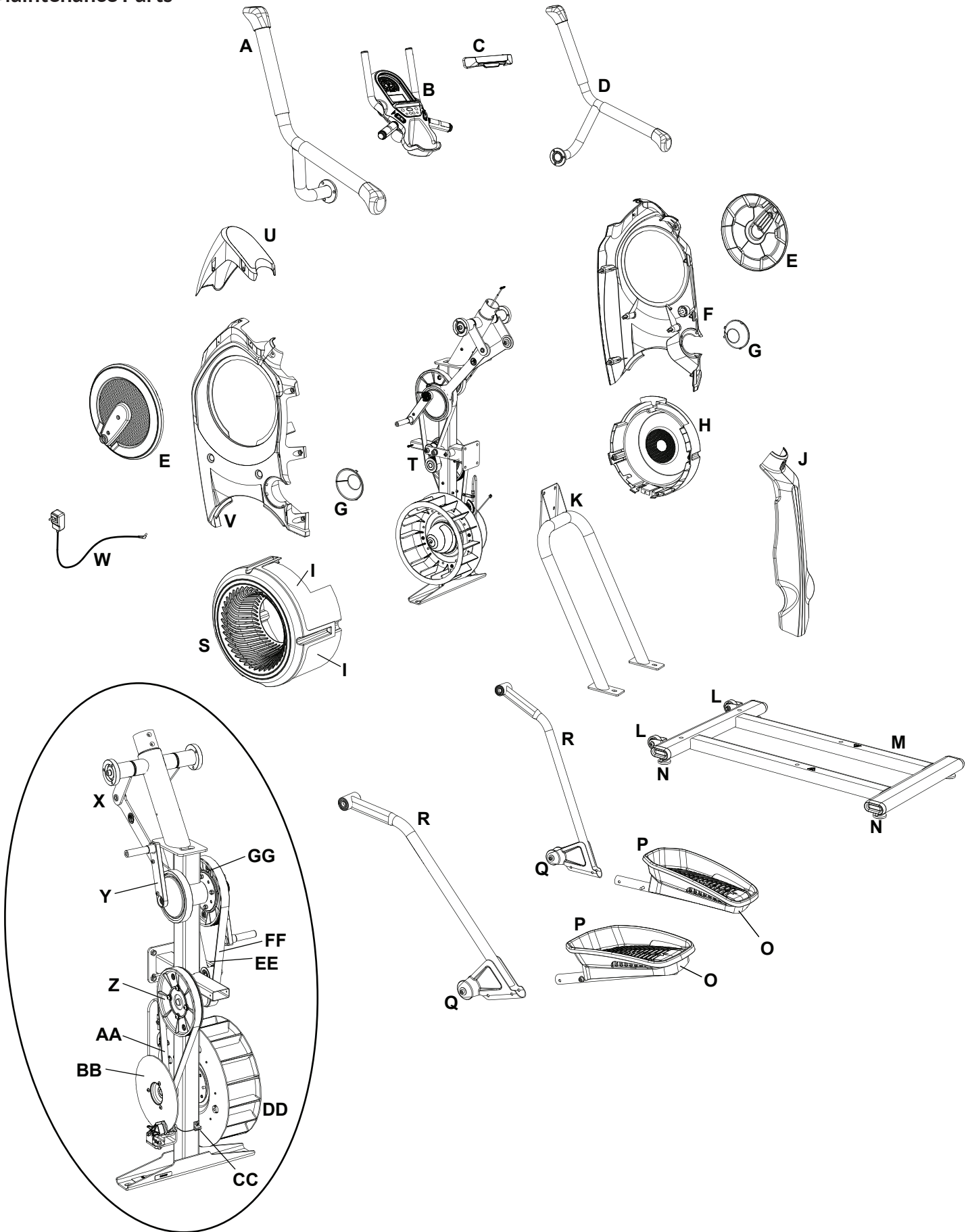

A	Dynamic Handlebar, Left	L	Transport Wheel	W	Power Cord
B	Console Assembly (w/Aerobars)	M	Stabilizer	X	Arm Drive Assembly
C	Media Capture Bar	N	Leveler	Y	Crank Arm
D	Dynamic Handlebar, Right	O	Pedal	Z	Drive Pulley, Lower
E	Crank Cover	P	Foot Pad	AA	Fan Belt
F	Shroud, Right	Q	Roller	BB	Disc Brake
G	Cap	R	Leg	CC	Speed Sensor
H	Shroud, Right Fan	S	Shroud, Left Fan	DD	Speed Sensor (behind Fan)
I	Fan Assembly Inserts	T	Frame Assembly	EE	Tensioner
J	Shroud, Rear	U	Upper Shroud	FF	Drive Belt
K	Rail Assembly	V	Shroud, Left	GG	Drive Pulley, Upper

# Troubleshooting

Condition/Problem	Things to Check	Solution
No display/partial display/unit will not turn on	Check electrical (wall) outlet	Make sure unit is plugged into a functioning wall outlet.
	Check connection at front of unit	Connection should be secure and undamaged. Replace adapter or connection at unit if either are damaged.
	Check data cable connections/orientation	Be sure cable is connected securely and oriented properly. Small latch on connector should line up and snap into place.
	Check data cable integrity	All wires in cable should be intact. If any are visibly crimped or cut, replace cable.
	Check console display for damage	Check for visual sign that console display is cracked or otherwise damaged. Replace Console if damaged.
	AC Adapter	Check for visual sign that AC Adapter is cracked or otherwise damaged. Replace AC Adapter if damaged.
	Console Display	If Console only has partial display and all connections are fine, replace the Console.
		If the above steps do not resolve the problem, contact Customer Service (if inside US/Canada) or your local distributor (if outside US/Canada).
No response on Console when button is pushed	Console Button Assembly	Try other buttons to get any response on the Console.
	Check data cable integrity from Console Button Assembly to Console	All wires in cable should be intact. If any are visibly crimped or cut, replace cable.
	Check data cable connections/orientation	Be sure cable is connected securely and oriented properly. Small latch on connector should line up and snap into place.
	Check console display for damage	Check for visual sign that console display is cracked or otherwise damaged. Replace Console if damaged.
	Check Console Button Assembly	Check for visual sign that the Console Button Assembly is otherwise damaged. Replace the Console Button Assembly if damaged.
		If the above steps do not resolve the problem, contact Customer Service (if inside US/Canada) or your local distributor (if outside US/Canada).
No speed/RPM reading	Check data cable integrity	All wires in cable should be intact. If any are cut or crimped, replace cable.
	Check data cable connections/orientation	Be sure cable is connected securely and oriented properly. Small latch on connector should line up and snap into place.
	Check magnet position (requires shroud removal)	Magnet should be in place on pulley.
	Check Speed Sensor (requires shroud removal)	Speed sensor should be aligned with magnet and connected to data cable. Realign sensor if necessary. Replace if there is any damage to the sensor or the connecting wire.
	Console Electronics	If tests reveal no other issues, contact Customer Service (if inside US/Canada) or your local distributor (if outside US/Canada).
Unit operates but Bluetooth® Heart Rate (HR) not displayed	Heart Rate Strap (not provided)	Make sure strap is directly against skin and contact area is wet.
	Heart Rate Strap Batteries	If strap has replaceable batteries, install new batteries.
	Interference	Try moving unit away from sources of interference (TV, Microwave, etc).
	Replace Chest Strap	If interference is eliminated and HR does not function, replace strap.
	Replace Console	If HR still does not function, replace Console.

Condition/Problem	Things to Check	Solution
Console shuts off (enters sleep mode) while in use	Check electrical (wall) outlet	Make sure unit is plugged into a functioning wall outlet.
	Check connection at front of unit	Connection should be secure and undamaged. Replace adapter or connection at unit if either are damaged.
	Check data cable integrity	All wires in the cable should be intact. If any are cut or crimped, replace cable.
	Check data cable connections/orientation	Be sure cable is connected securely and oriented properly. Small latch on connector should line up and snap into place.
	Reset machine	Unplug unit from electrical outlet for 5 minutes. Reconnect to outlet.
	Check magnet position (requires shroud removal)	Magnet should be in place on pulley.
	Check Speed Sensor (requires shroud removal)	Speed sensor should be aligned with magnet and connected to data cable. Realign sensor if necessary. Replace if there is any damage to the sensor or the connecting wire.
Pedals will not move	Pedal locations	The Pedals may be "bottomed out". Safely grasp the Static Handlebars and apply your weight to the heel of the higher foot. While still grasping the Static Handlebar, lean back slightly applying more weight onto the heel. Once the Pedals begin to move, resume your intended workout.
Fan will not turn	Check for blockage of fan	Remove material from fan. Be sure not to move the Handlebars, Legs or Pedals.  <b>Be aware that the Fan, Handlebars, Legs and Pedals are connected and when either of these parts move the other does as well.</b> If necessary, detach the Shrouds to help with removal. Do not operate machine until Shrouds have been replaced.
Unit rocks/does not sit level	Check leveler adjustment	Adjust levelers until machine is level.
	Check surface under unit	Adjustment may not be able to compensate for extremely uneven surfaces. Move machine to level area.
Foot pedals loose/unit difficult to operate	Hardware	Tightly secure all hardware on the Pedal Arms and Handlebar Arms.
Rubbing sound outside of Shrouds during operation	Caps	Slightly loosen Caps on Crank Arms
Metallic rubbing sound from within Shrouds during operation	Brake bracket	Brake bracket needs to be aligned. Contact Customer Service (if inside US/Canada) or your local distributor (if outside US/Canada).
Machine seems to release Pedals for a moment during operation	Belt slip	Contact Customer Service (if inside US/Canada) or your local distributor (if outside US/Canada).
Workout results will not sync with Bluetooth® enabled device	Current console mode	Machine must be in Idle Mode to sync. Push the PAUSE/STOP button until the "GET READY" screen is displayed.
	Total time of workout	A workout must be longer than 1 minute to be saved and posted by the Console.
	Fitness machine	Unplug unit from electrical outlet for 5 minutes. Reconnect to outlet.
	Bluetooth® enabled device	Consult your device to be sure that the Bluetooth® wireless feature has been enabled on it.
	Fitness App	Review Specifications of Fitness App and confirm your device is compatible.
		Contact <a href="mailto:appsupport@nautilus.com">appsupport@nautilus.com</a> (if inside US/Canada) or your local distributor (if outside US/Canada) for further assistance.

# Bowflex™ Body Weight Loss Guide

## Introduction and Overview

Welcome to the Bowflex™ Body Weight Loss Guide. This guide is designed to be used with your Bowflex™ equipment and will help you:

- Lose weight and get lean
- Improve your health and wellness
- Increase your energy and vitality

**⚠ Consult a physician before you start an exercise program or a new health and diet plan. Stop exercising if you feel pain or tightness in your chest, become short of breath, or feel faint. Contact your doctor before you use the machine again. Use the values calculated or measured by the machine's computer for reference purposes only. The heart rate displayed on the console is an approximation and should be used for reference only.**

By focusing on the main three elements of the Bowflex™ Body Weight Loss Guide- quality, balance, and consistency- you'll be able to reach and maintain your weight loss and fitness goals for the next six weeks and beyond.

- **Quality** – The emphasis of this plan is on eating more whole foods and getting the most nutrients from your calories as possible. Making the majority of your diet from foods that have a single ingredient (for example fruits, vegetables, fish, lean protein, eggs, beans, nuts, and whole grains) provides the vitamins, minerals, fiber, protein, and healthy fats your body needs.
- **Balance** – Each of the meals and snacks in this guide have a source of fiber or smart carbohydrate, protein, and healthy fat to keep your energy levels consistent throughout the day to fuel your workouts. By having this balance you'll feel fuller longer, which is critical to weight loss success.
- **Consistency** – Getting about the same number of calories each day is important for your metabolism and your mindset. If you overdo it one day, don't try to make up for it the next day by not eating or cutting your calories drastically. Get right back on track by following this guide!

## Results & Expectations

Results will vary depending on your age, starting weight, and exercise level. By adhering to a diet and exercise routine, you may lose 1-3 lbs per week and experience increased energy levels.

## 5 Tips for Long-Term Success

1. **Keep a food log** including hunger levels and water intake. Free online food logs and mobile apps are available at [www.myfitnesspal.com](http://www.myfitnesspal.com) and [www.loseit.com](http://www.loseit.com)
2. **Weigh and/or take measurements weekly** – no more and no less. Weighing weekly rather than daily or every other day is best. You'll track your progress and keep yourself in check without getting discouraged if the scale doesn't move for a few days. And remember, weight is just a number and it's influenced by muscle gain as well as fat loss. Feeling how your clothes fit can often be a better indicator of progress as your body adapts to exercise and nutrition changes.
3. **Measure portions** – To avoid portion creep, use measuring cups and spoons for grains (rice, pasta, cereal), beans, nuts, oils, and dairy. Use the Portion Sizes Guide for other foods.
4. **Plan ahead** – Make a meal plan for the week or log your food a day in advance. Planning sets you up for success, especially for social events and eating out.
5. **Practice your desired long-term habits** – It's easy to justify poor eating choices when you're only focused on the short term. Focus on the long term satisfaction of a slimmer, healthier you rather than the temporary gratification you'll get from splurging.

## How to Use this Guide

- **Eat breakfast within 90 minutes of waking up and balance your meals and snacks throughout the day**
  - Don't go longer than 5-6 hours without eating
  - If you're not used to eating breakfast, start out small with a piece of fruit and have something else 1-2 hours later. Your body adapts to not eating breakfast, but as soon as you start eating early in the day and cutting back on dinner portions you'll notice your hunger will increase. This is a good sign your metabolism is working!
- **Mix and match meal options**
  - Select 1 option from the appropriate meal plan (male or female) for breakfast, lunch, and dinner, paying close attention to portion sizes
  - Select 1-2 snack options per day
  - You have the option to substitute one snack for one treat under 150 calories



- Use the meal plan, sample options, and grocery list to create your own meals for more variety
- You can swap out any type of protein, vegetables or smart carbs for the suggested meal options. For example:
  - Turkey for tuna
  - Any fish or seafood for chicken
  - Cooked vegetables instead of salad
- **Eat your calories**
  - Cut out high calorie beverages like soda, juices, coffee drinks, and alcohol
  - Stick with water, unsweetened tea, and coffee. Aim for a minimum of 64oz (1.9 liters) of water per day to stay well hydrated
- **If you're still hungry after or in between meals:**
  - Have a glass of water and wait 15-20 minutes. Many times we mistake thirst (or even boredom!) for hunger. Wait out the initial urge to eat and sometimes it will pass.
  - If you're still hungry after waiting 15-20 minutes have a snack or mini-meal with fruit, vegetables, and protein.

#### **If your goal is muscle gain or strength:**

- Use the same meal plan but increase portion sizes in the same ratios to increase the total number of calories you eat every day. For example, increase portion sizes of protein and smart carbs at meals by 50%. Adding a snack is another option to meet your body's increased calorie needs in order to gain muscle and strength.
- Focus on post-workout nutrition by having one of your snacks within 30 minutes after you complete your workout. Make sure to have a combination of carbohydrates such as fruit with protein (yogurt, milk, or protein powder) to promote muscle growth and recovery. Chocolate milk is also a great option.

## **Meal Plan Overview**

The female meal plan provides about 1400 calories, and the male plan provides about 1600 calories, of high quality nutrition to not only help you lose weight and feel great but get the most out of your calories. The vitamins, minerals, and antioxidants from eating mostly whole foods help support optimal health. These calorie levels will result in healthy weight loss for the majority of people. Keep in mind that everyone's metabolism is very different depending on age, height, weight, activity level, and genetics. Pay close attention to your weight, hunger levels, and energy and adjust your calories if needed.

#### **Follow these guidelines if you're over 55:**

- If you're over 55, you need fewer calories because your metabolism slows as you age. Stick with three meals with one optional snack per day.

#### **Follow these guidelines if you're under 25:**

- If you're under 25 you may need more calories. Add another snack if you feel low on energy or are extremely hungry.

## **Breakfast**

Breakfast includes a smart carb, fruit, and a source of protein, which will also have fat. With a balance of carbohydrates and fiber from the smart carb and fruit combined with protein and fat, you'll energize your day and help control hunger levels throughout the day.

## **Snacks**

Each snack is a balance of carbohydrates and protein to keep your blood sugar more consistent, which means you won't experience hunger and energy level spikes and drops.

This happens when you have a high carb-only snack like chips, candy, soda, crackers, or pretzels.

## **Lunch and Dinner**

Lunch combines filling fiber from vegetables and smart carbs with a lean, or low-fat, protein. The healthy fat can come either from the protein added during cooking (nuts on a salad) or as a dressing or sauce (such as oil and vinegar salad dressing).

Here's an overview of what an ideal day looks like:  
(See Portion Size Guide for proper serving sizes)

### Breakfast

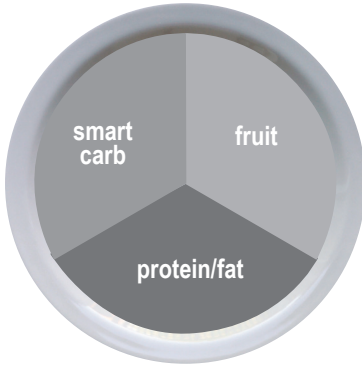

### Snack #1

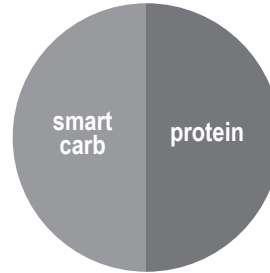

### Lunch

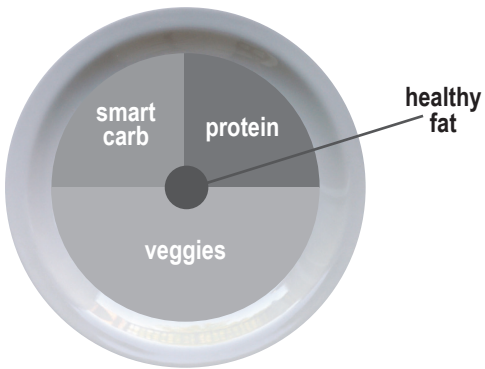

### Snack #2

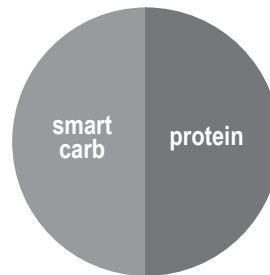

### Dinner

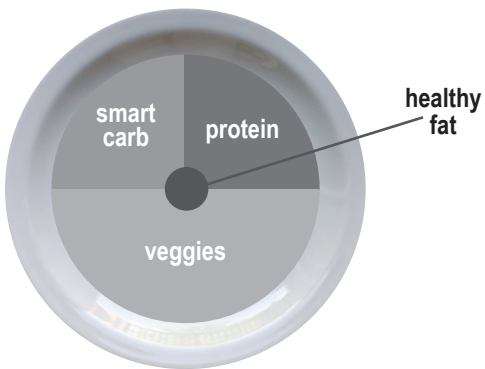

<b>Breakfast Options</b>	<b>Fruit</b>	<b>Smart Carb</b>	<b>Protein/Fat</b>
<b>Fruit and Nut Oatmeal</b> Cook plain oats in water. Top with fruit, nuts, milk, cinnamon, and honey.	Berries or banana	Plain oats (Regular or quick-cook)	Nuts and milk
<b>Egg Muffin</b> Cook egg/s. Toast bread and top with 1 slice of cheese, 1 slice of ham, and tomato.	Tomato	English muffin or sandwich thin	Egg, ham, and cheese
<b>Yogurt Power Parfait</b> Top yogurt with fruit. Sprinkle with 1 serving of nuts, 2-3 tbsp wheat germ, or ground flaxseed, 1 tbsp oats, and cinnamon.	Chopped fruit of your choice	Oats, wheat germ, and ground flaxseed	Plain non-fat Greek yogurt and nuts
<b>On the Go PB &amp; Apple Sandwich</b> Toast bread. Spread on peanut butter, thin slices of ½ an apple, and 1 teaspoon of honey.	Sliced apple	Sandwich thin, bread, or bagel thin	Peanut butter

<b>Lunch &amp; Dinner Options</b>	<b>Lean Protein</b>	<b>Smart Carb</b>	<b>Veggies</b>
<b>Pork Loin, Sweet Potato &amp; Green Beans</b>	Grilled or baked pork loin	Baked Sweet Potato	Green Beans
<b>Chicken Stir Fry</b> Flavor with 2 tablespoon teriyaki sauce	Chicken breast or boneless skinless thigh	Brown or wild rice	Mixed stir fry vegetables (fresh or frozen)
<b>Steak Tacos with Side Salad</b> (3 for males, 2 for females) Top with salsa, cilantro, and sprinkle of shredded cheese	Flank or sirloin steak	Corn tortillas	Salad
<b>Whole Wheat Pasta with Shrimp or Cannellini Beans &amp; Marinara Sauce</b>	Shrimp (frozen or fresh) or cannellini beans	Whole wheat pasta	Steamed broccoli
<b>Bunless Burgers with Oven Fries, Corn, &amp; Salad</b> Grill burgers. Bake sliced potatoes on sprayed cookie sheet for 25-30 minutes @ 425°F.	93% lean ground beef or turkey	Oven baked fries	Corn on the cob + side salad
<b>Tuna &amp; Avocado Wrap with Vegetable Soup</b> Use 3oz of tuna (1 can). Top with lettuce, tomato, avocado, and mustard.	Tuna	High-fiber wrap	Vegetable soup (homemade or low-sodium canned)

Snack Options	
Smart Carb	Protein
1 medium apple	10-15 almonds
Baby carrots	2 tbsp hummus
1 serving of crackers*	1 string cheese
Energy or protein bar with <200 calories*	

\*See [www.Bowflex.com/Resources](http://www.Bowflex.com/Resources) for brand recommendations

## Optional Treats

You have the choice of replacing Snack #2 with a 100-150 calorie treat. You can have an optional treat every day but for optimal health it is recommended to limit small splurges to 3-4 times per week. Use the approach that works best for you. Here are a few examples:

- ½ cup lowfat ice cream
- 1 small bag of baked potato chips
- 4oz of wine or 12oz light beer
- 3 cups of air-popped or light popcorn

## Sample 3 Day Plan

Based on each of the meal options listed above, a typical 3 day plan could look like this:

	Day 1	Day 2	Day 3
<b>Breakfast</b>	Egg muffin	Power yogurt parfait	Fruit + nut oatmeal
<b>Snack 1</b>	Apple with almonds	Nut Thins® + string cheese	Baby carrots and hummus
<b>Lunch</b>	Tuna & avocado wrap with soup	Leftovers from dinner- day 1	Leftovers from dinner- day 2
<b>Optional Snack 2 or Treat</b>	½ cup ice cream bar	Energy bar	100 calorie bag of light popcorn
<b>Dinner</b>	Shrimp pasta	Chicken stir fry	Bunless burgers

## Portion Size Guide

Each of the items listed are for one serving

MALE	FEMALE
<b>PROTEIN</b>	
2 eggs 5oz chicken, fish, lean meat, or tofu 2/3 cup beans or lentils* 1 cup greek yogurt* 1.5oz cheese*	1 egg 3oz chicken, fish, or lean meat 1/2 cup beans or lentils* 1/2 cup greek yogurt* 1.5oz cheese*
<b>HEALTHY FAT</b>	
2 Tblspn peanut or nut butter* 2 tspn olive, flax, or walnut oil 1/4 cup of nuts 1/3 medium avocado	1 tblspn peanut or nut butter* 1 tspn olive, flax or walnut oil 1/8 cup or 2 tablespoons of nuts (approx. 15 almonds) 1/4 medium avocado
<b>SMART CARB</b>	
1 cup cooked grains (1/2 cup raw): oats, brown rice, quinoa, pasta 1 medium sweet or regular potato 2 corn tortillas 1 slice of bread (or 2 light slices equaling 120 calories or less) 1 english muffin, sandwich thin, or high-fiber wrap	1/2 cup cooked (1/4 cup raw) grains 1/2 medium sweet potato or regular potato 2 corn tortillas 1 slice of bread (or 2 light slices equaling 120 calories or less) 1 english muffin, sandwich thin, or high-fiber wrap
<b>FRUIT</b>	
1 medium apple, orange, or pear 1 small banana (length of your hand) 1 cup berries or chopped fruit 1/4 cup dried fruit (fresh or frozen is optimal)	
Vegetables* You can have unlimited vegetables except for peas and corn; stick with 1/2 cup serving	
2 cups spinach or lettuce = 2 cupped hands 1 cup raw vegetables 1/2 cup cooked vegetables 6oz low sodium vegetable juice	
<b>OPTIONAL TREATS</b>	
1/2 cup lowfat ice cream 1 small bag of baked potato chips 1oz dark chocolate 4oz of wine or 12oz light beer 3 cups air-popped or light popcorn	

\* some foods are a combination of protein and carbs or protein and fat

## Portion Samples:



1 cup = baseball



1/2 cup = lightbulb



1 oz or 2 tbsp = golf ball

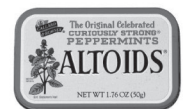

1/4 cup nuts = Altoids tin



3 oz chicken or meat = deck of cards



1 medium potato = computer mouse



1 medium piece of fruit = tennis ball



1 - 1/2 oz cheese = 3 dice

## Grocery List

<b>BREAD &amp; GRAINS</b>							
100% whole wheat bread Sprouted grain breads Light or whole wheat english muffins Sandwich or bagel thins Corn or low-carb whole wheat tortillas High-fiber wraps Plain oats: 1 minute or old fashioned Whole grains: brown rice, bulgar, barley, quinoa, couscous	Tips: Look for 100% whole wheat as the first ingredient. Look for 4g of fiber per slice or 5g per 2 slices of light or diet bread. Aim for bread with less than 100 calories per slice.						
<b>DAIRY &amp; DAIRY ALTERNATIVES</b>	<b>CRACKERS, SNACKS &amp; ENERGY BARS</b>						
Plain non-fat greek yogurt Kefir (yogurt like drink) Organic low-fat milk Enriched almond or soy milk Cheese: feta, parmesan, mozzarella, light havarti, provolone, swiss, string cheese, or single serving packages	<table border="1"> <tr> <td>Any unsalted nuts or seeds</td> <td>Energy bars</td> </tr> <tr> <td>Air-popped or light popcorn</td> <td>Crackers</td> </tr> <tr> <td>Edamame in the pod</td> <td>Hummus</td> </tr> </table>	Any unsalted nuts or seeds	Energy bars	Air-popped or light popcorn	Crackers	Edamame in the pod	Hummus
Any unsalted nuts or seeds	Energy bars						
Air-popped or light popcorn	Crackers						
Edamame in the pod	Hummus						
<b>MEAT, FISH, POULTRY &amp; PROTEIN</b> Wild game Salmon, halibut, tuna, tilapia, shrimp, catfish, scallops, or crab Pork loin, pork chops, or pork roast Chicken or turkey breast or thighs (no skin) Eggs and 100% egg whites Lean beef: sirloin, chuck, round, tenderloin, 93% lean (organic and grass fed is best) Canned salmon or tuna (in water) Nitrate-free, reduced sodium ham, turkey, chicken, or roast beef lunch-meat Any type of bean, dry or canned low-sodium varieties Tofu and tempeh Tips: Look for "Choice" or "Select" cuts of meat rather than "Prime". Prime cuts are fattier. Limit intake of highly processed meat and imitation meat products like sausage, bacon, pepperoni, and hot dogs to once a week or less.	Tips: Limit crackers, pretzels, and chips to 2-3 servings per week. Always pair with protein such as hummus, cheese, or nuts. Look for energy bars with less than 200 calories and 20g of sugar and at least 3g of protein and 3g of fiber. Look for crackers with less than 130 calories and 4g or less of fat per serving.						
<b>FROZEN FOODS</b> All vegetables without sauce All fruit Grains and grain medleys	<b>FATS &amp; OILS</b> Avocado Olive, grapeseed, walnut, sesame, or flaxseed oil Butter/spreads: look for products free of trans fats and partially hydrogenated oils on the ingredient list. Tips: Light olive oil refers to the flavor, not the calorie content. Always measure oil and butter. Even if a fat is considered healthy, it's still very high in calories and portions need to be controlled.						
	<b>DRESSINGS, CONDIMENTS &amp; SAUCES</b> Vinegars: rice, wine, balsamic All fresh or dried herbs and spices Mustard Salsa and chili sauce Marinara sauce with no high-fructose corn syrup Lemon and lime juice Bottled minced garlic and ginger Low-sodium soy sauce Tips: Look for products free of MSG, added colors, and high fructose corn syrup. Look for sauces under 50 calories per serving. Avoid cream based sauces and dressings like ranch, bleu cheese, and alfredo.						

All fruits and vegetables, fresh and frozen, are great choices. Since every meal has one or both, your shopping cart should reflect this.

## Keep It Going

### Tips for continued weight loss and maintaining changes

- **Keep weighing yourself weekly**, even after you've reached your goal weight
- **Continue keeping a food log**. If you have your meal plan well-established, log your food every other week to keep yourself on track. Don't feel like you have to do it every day.
- **Prepare for plateaus**. The scale might not budge for a few weeks or even months after some initial weight loss. This is normal and to be expected. It's the body's natural process for adjusting to your new lower weight. Stay focused on your long-term goal, celebrate your successes and changes, and mix up your workouts to help overcome the plateau.
- **Calorie adjustments for maintaining weight loss**. Once you've reached your goal weight, you can increase your calories 100-200 per day as long as your activity level stays the same
- **Treat yourself**. Have a non-food reward for each goal you hit such as a massage, a new outfit, or an outing with friends and family
- **Use the resources below** to find new recipes, get expert advice, and support to stay motivated

## Resources

### Downloadable Resources from Bowflex™ Website ([www.Bowflex.com/Resources](http://www.Bowflex.com/Resources))

- Grocery Shopping List for Fridge (Blank Form)
- 7 Day Meal Planning Form
- Additional Dinner Options
- Pre and Post Workout Fueling Guide

### Questions & Support

- Ask questions, post suggestions, and connect with our online Bowflex™ Dietitian on the Bowflex Facebook page

### Recipes

- [www.wholeliving.com](http://www.wholeliving.com)
- [www.eatingwell.com](http://www.eatingwell.com)
- [www.whfoods.org](http://www.whfoods.org)
- [www.livebetteramerica.org](http://www.livebetteramerica.org)

### Online food logs

- [www.myfitnesspal.com](http://www.myfitnesspal.com)
- [www.loseit.com](http://www.loseit.com)



# Buy Back Guarantee *( if purchased in US/Canada )*

We want you to know that your Bowflex™ Max Trainer™ machine is a superior product. Your satisfaction is guaranteed. If, for any reason, you are not 100% satisfied with your Bowflex™ Max Trainer™ machine, please follow the instructions below to return your merchandise and receive a refund of the purchase price, less shipping and handling.

This Bowflex™ Max Trainer™ Buy Back Guarantee applies only to merchandise purchased by consumers directly from Nautilus, Inc. This guarantee does not apply to sales made by dealers, retailers, or distributors.

1. Call a Bowflex™ Max Trainer™ Representative at 1-800-605-3369 for a Return Authorization Number (RMA). An RMA will be granted if:
  - a. The Bowflex™ Max Trainer™ exercise machine was purchased directly from Nautilus, Inc.
  - b. The request to return the product is within 6 weeks of the delivery date of your merchandise.
  
2. If an RMA is granted, the following instructions will prevent delays in the processing of your refund.
  - a. The merchandise must be returned to the address given to you at the time of the Return Authorization Call.
  - b. All returned merchandise must be properly packaged in good condition, preferably in the original boxes.
  - c. The exterior of the boxes should be marked clearly with:
    - Return Authorization Number
    - Your Name
    - Your Address
    - Your Phone Number
  - d. Additionally, a piece of paper with your name, address and phone number or copies of your original invoice should be placed in each box of merchandise.
  - e. Your RMA number is time sensitive. Your shipment must be post marked within two weeks from the date the Bowflex™ Max Trainer™ Representative issued the Return Authorization Number.

Note: You are responsible for return shipping and for any damage or loss to merchandise that occur during return shipment. Nautilus recommends that you obtain tracking numbers and insure your shipment.

## Unauthorized Returns

Nautilus, Inc. defines an unauthorized return as any merchandise returned to our facilities without a valid and current Return Merchandise Authorization (RMA) number issued by Nautilus. Failure to properly mark packages with a valid RMA number, or allowing an RMA number to expire, will cause Nautilus, Inc. to consider a return unauthorized. Any merchandise returned without a RMA number will not be subject to a refund or credit and Nautilus will discard the product. The customer assumes all shipping and handling charges for any unauthorized return.

#### Who Is Covered

This warranty is valid only to the original purchaser and is not transferable or applicable to any other person(s).

#### What Is Covered

Nautilus, Inc. warrants that this product is free from defects in materials and workmanship, when used for the purpose intended, under normal conditions, and provided it receives proper care and maintenance as described in the Product's Assembly and Owner's manual. This warranty is good only for authentic, original, legitimate machines manufactured by Nautilus, Inc. and sold through an authorized agent and used in the United States or Canada.

#### Terms

Warranty terms for products purchased in US/Canada are as stated below.

- Frame 2 years
- Parts 2 years
- Labor 90 days

(Labor support does not include the installation of replacement parts involved in the initial product assembly and preventative maintenance services. All repairs covered under the labor portion of the warranty must be preauthorized by Nautilus. The customer will be responsible for a minimal trip charge.)

For warranty & service of products purchased outside US/Canada, please contact your local distributor. To find your local international distributor, go to: [www.nautilusinternational.com](http://www.nautilusinternational.com)

#### How Nautilus Will Support the Warranty

Throughout the terms of the warranty coverage, Nautilus, Inc. will repair any machine that proves to be defective in materials or workmanship. Nautilus reserves the right to replace the product in the event a repair is not possible. When Nautilus determines replacement is the correct remedy, Nautilus may apply a limited credit reimbursement toward another Nautilus, Inc. brand Product, at our discretion. This reimbursement may be prorated based on length of ownership. Nautilus, Inc. provides repair service within major metropolitan areas. Nautilus, Inc. reserves the right to charge the consumer for travel outside these areas. Nautilus, Inc. is not responsible for dealer labor or maintenance charges beyond the applicable warranty period(s) stated herein. Nautilus, Inc. reserves the right to substitute material, parts or products of equal or better quality if identical materials or products are not available at the time of service under this warranty. Any replacement of the product under the terms of the Warranty in no way extends the original Warranty period. Any limited credit reimbursement may be prorated based on length of ownership. **THESE REMEDIES ARE THE EXCLUSIVE AND SOLE REMEDIES FOR ANY BREACH OF WARRANTY.**

#### What You Must Do

- Retain appropriate and acceptable Proof of Purchase.
- Operate, maintain, and inspect the Product as specified in the Product Documentation (Assembly, Owner's Manuals, etc.).
- Product must be used exclusively for the purpose intended.
- Notify Nautilus within 30 days after detecting an issue with the Product.
- Install replacement parts or components in accordance with any Nautilus instructions.
- Perform diagnostic procedures with a trained Nautilus, Inc representative if requested.

#### What Is Not Covered

- Damage due to abuse, tampering or modification of the Product, failure to properly follow assembly instructions, maintenance instructions, or safety warnings as stated in the Product Documentation (Assembly, Owner's Manuals, etc), damage due to improper storage or the effect of environmental conditions such as moisture or weather, misuse, mishandling, accident, natural disasters, power surges.
- A machine placed or used in a commercial or institutional setting. This includes gyms, corporations, work places, clubs, fitness centers and any public or private entity that has a machine for use by its members, customers, employees or affiliates.
- Damage caused by exceeding maximum user weights as defined in the Product's Owner's manual or warning label.
- Damage due to normal usage and wear and tear.
- This warranty does not extend to any territories or countries outside the United States and Canada.

#### How to Obtain Service

For Products purchased directly from Nautilus, Inc. contact the Nautilus office listed on the Contacts page of the products Owner's manual. You may be required to return the defective component to a specified address for repair or inspection, at your expense. Standard ground shipping of any warranty replacement parts will be paid by Nautilus, Inc. For products purchased from a retailer, you may be asked to contact your retailer for warranty support.

#### Exclusions

The preceding warranties are the sole and exclusive express warranties made by Nautilus, Inc. They supersede any prior, contrary or additional representations, whether oral or written. No agent, representative, dealer, person or employee has the authority to alter or increase the obligations or limitations of this warranty. Any implied warranties, including the WARRANTY OF MERCHANTABILITY and any WARRANTY OF FITNESS FOR A PARTICULAR PURPOSE, are limited in duration to the term of the applicable express warranty provided above, whichever is longer. Some states do not allow limitations on how long an implied warranty lasts, so the above limitation may not apply to you.

#### Limitation of Remedies

EXCEPT AS OTHERWISE REQUIRED BY APPLICABLE LAW, THE PURCHASER'S EXCLUSIVE REMEDY IS LIMITED TO REPAIR OR REPLACEMENT OF ANY COMPONENT DEEMED BY NAUTILUS, INC. TO BE DEFECTIVE UNDER THE TERMS AND CONDITIONS STATED HEREIN. IN NO EVENT WILL NAUTILUS, INC. BE LIABLE FOR ANY SPECIAL, CONSEQUENTIAL, INCIDENTAL, INDIRECT OR ECONOMIC DAMAGES, REGARDLESS OF THE THEORY OF LIABILITY (INCLUDING, WITHOUT LIMITATION, PRODUCT LIABILITY, NEGLIGENCE OR OTHER TORT) OR FOR ANY LOST REVENUE, PROFIT, DATA, PRIVACY OR FOR ANY PUNITIVE DAMAGES ARISING OUT OF OR RELATED TO THE USE OF THE FITNESS MACHINE EVEN IF NAUTILUS, INC. HAS BEEN ADVISED OF THE POSSIBILITY OF SUCH DAMAGES. THIS EXCLUSION AND LIMITATION SHALL APPLY EVEN IF ANY REMEDY FAILS OF ITS ESSENTIAL PURPOSE. SOME STATES DO NOT ALLOW THE EXCLUSION OR LIMITATION OF CONSEQUENTIAL OR INCIDENTAL TYPE DAMAGES SO THE ABOVE LIMITATION MAY NOT APPLY TO YOU.

#### State Laws

This warranty gives you specific legal rights. You may also have other rights, which vary from state to state.

#### Expirations

If the warranty has expired, Nautilus, Inc. may assist with replacements or repairs to parts and labor, but there will be a charge for these services. Contact a Nautilus office for information on post-warranty parts and services. Nautilus does not guarantee availability of spare parts after expiration of warranty period.

#### International Purchases

If you purchased your machine outside of the United States consult your local distributor or dealer for warranty coverage.

