

**Table of Contents**

Section Code	Section	Page Number
1	Important Safety Instructions	2
1	Safety Warning Labels and Serial Number	3
1	Specifications	4
1	Grounding Instructions	5
1	Emergency Stop Procedure	6
1	Moving and Storing the Machine	7
1	Unfolding the Machine	9
1	Leveling the Machine	10
1	Treadmill Belt (break in period)	10
1	Connectivity	11
1	Maintenance	12
1	Cleaning	12
1	Adjusting the Belt Tension	13
1	Aligning the Walking Belt	13
1	Lubricating the Walking Belt	14
1	Heart Rate Chest Strap Battery Replacement	15
1	Maintenance Parts	16
1	Troubleshooting	18
1	Machine Settings Mode	30
1	Engineering Mode	31
1	Electrical Wiring Diagram	32
1	Replacement Procedure Skill Level	33
	Mechanical / Modification Procedures	
2	Adjust the Walking Belt	34
	Part Replacement	
3	Replace the Circuit Breaker	36
4	Replace the Console Assembly	40
5	Replace the Deck Suspension	43
6	Replace the Deck Wheel	46
7	Replace the Drive Belt	49
8	Replace the Front Roller	54
9	Replace the Incline Motor Assembly	59
10	Replace the Lift Shock	66
11	Replace the Lower I/O Cable	70
12	Replace the Middle I/O Cable	75
13	Replace the Motor	80
14	Replace the Motor Control Board (MCB)	86
15	Replace the Motor Control Board Cover	90
16	Replace the Motor Cover	92
17	Replace the Motor Mount	94
18	Replace the Power Inlet	98
19	Replace the Rear Roller	102
20	Replace the Rear Roller Cover	106
21	Replace the Right Upright	109
22	Replace the Rocker Switch (On/Off)	115
23	Replace the Side Rail	119
24	Replace the Speed Sensor Assembly	123
25	Replace the Transport Wheel	127
26	Replace the Walking Belt	130
27	Replace the Walking Deck	139
28	Installation of the Walking Deck Kit	146
29	Update Firmware	153

**NOTICE:** This document provides important safety instructions, adjustments, and general troubleshooting information for the maintenance of the Bowflex™ BXT6 / BXT028 Treadmill.

If you need assistance, please contact Customer Service (if purchased in US/Canada) or your local distributor (if purchased outside US/Canada). To find your local distributor, go to: [www.nautilusinternational.com](http://www.nautilusinternational.com)

 This icon means a potentially hazardous situation which, if not avoided, could result in death or serious injury. Read and understand all Warnings on this machine.

Nautilus, Inc., [www.NautilusInc.com](http://www.NautilusInc.com), 5415 Centerpoint Parkway, Groveport, OH 43125 U.S.A. - Customer Service: North America (800) 605-3369, [csnls@nautilus.com](mailto:csnls@nautilus.com) | outside U.S. [www.nautilusinternational.com](http://www.nautilusinternational.com) | Printed in China | © 2018 Nautilus, Inc. | Bowflex and the B logo are trademarks owned or licensed by Nautilus, Inc., registered or otherwise protected by common law in the United States and other nations. The Bluetooth® word mark and logos are registered trademarks owned by Bluetooth SIG, Inc., and any use of such marks by Nautilus, Inc. is under license. | **ORIGINAL DOCUMENT - ENGLISH VERSION ONLY**

## Important Safety Instructions

 This icon means a potentially hazardous situation which, if not avoided, could result in death or serious injury. Read and understand all Warnings on this machine.

**Before servicing or using this equipment, obey the following warnings:**

 Read and understand the Service Manual before working on the machine. Failure to obey the instructions and safety warnings could cause injury to the service technician or bystanders.

**⚠ DANGER** To reduce the risk of electrical shock or unsupervised usage of the equipment, always unplug the power cord from the wall outlet and/or the machine and wait 5 minutes before cleaning, maintaining or repairing the machine. Place the power cord in a secure location.

- Keep bystanders and children away from the product being serviced at all times.
- Make sure that the repair is done in an appropriate work space away from foot traffic and exposure to bystanders.
- Some components of the equipment can be heavy or awkward. Enlist the service of a second person when you do maintenance steps involving these components. Do not try to do heavy or awkward steps on your own.
- Use only replacement parts and hardware that are supplied or approved by Nautilus. Failure to use Nautilus-approved replacement parts can adversely affect the safety and functionality of the equipment creating a risk to users and will void the warranty.
- Be sure that all warning stickers and instructional placards applied to the product stay present and in good condition when doing maintenance or replacing components. If at any time the Warning labels become loose, unreadable or dislodged, replace the labels. If purchased in US/Canada, contact Customer Service for replacement labels. If purchased outside US/Canada, contact your local distributor for them.
- Do not try to change the design or functionality of the machine being serviced as this can adversely affect user safety and will void the warranty.
- Do not put the machine back in service until all shrouds, instructions, warning labels and correct functionality have been verified and tested for correct performance.
- SAVE THESE INSTRUCTIONS.

# SAFETY WARNING LABELS AND SERIAL NUMBER



## CAUTION

Risk of Injury to Persons - To Avoid injury, use extreme caution when stepping onto or off of a moving belt. Read instruction manual before using.

## WARNING!

- Injury or death is possible if caution is not used while using this machine.
- Keep children and pets away.
- Read and follow all warnings on this machine.
- Refer to the Owner's Manual for additional warnings and safety information.
- The heart rate displayed is an approximation and should be used for reference only.
- Not intended for use by anyone under 14 years of age.
- The maximum user weight for this machine is 136 kg. (300 lbs)
- This machine is for home use only.
- Consult a physician prior to using any exercise equipment.

(Label is available in English and French Canadian only.)



## WARNING!

### HAZARDOUS VOLTAGE.

- Contact may cause electrical shock or burn.
- Turn off and lock out power before servicing.



## WARNING!

- Moving parts can crush and cut.
- Keep guards in place.
- Lock out power before servicing.

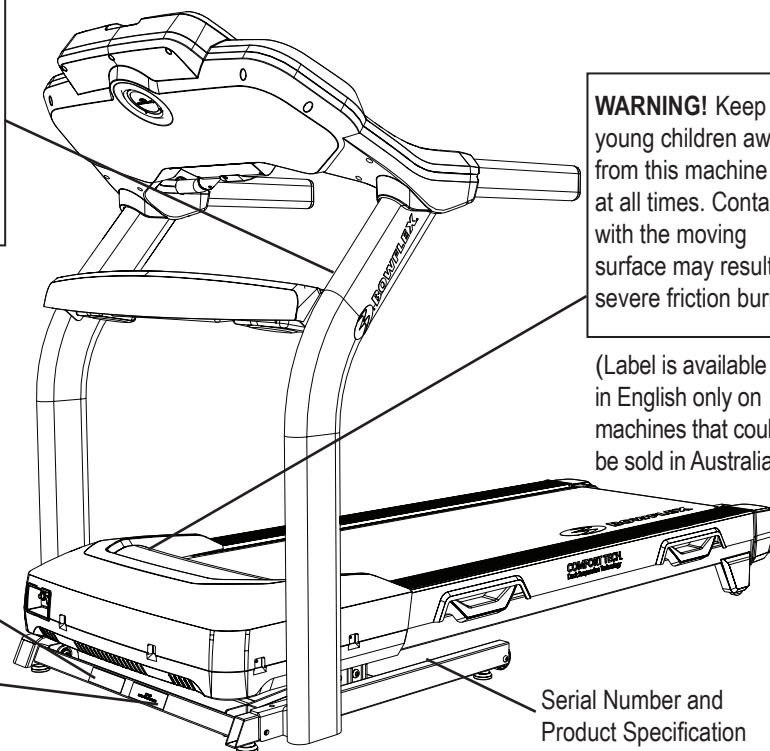

**WARNING!** Keep young children away from this machine at all times. Contact with the moving surface may result in severe friction burns.

(Label is available in English only on machines that could be sold in Australia.)

Serial Number and Product Specification

# SPECIFICATIONS

<b>Power Requirements:</b>	<b>120V</b>	<b>220V</b>
Operational Voltage:	120V AC, 60Hz	220V - 240V AC, 50/60Hz
Operating Current:	15 A	8 A
Heart Rate Chest Strap:	1 CR2032 battery	1 CR2032 battery

<b>Maximum User Weight:</b>	136 kgs (300 lbs)
<b>Total Surface Area (footprint) of equipment:</b>	17990 cm <sup>2</sup>
<b>Maximum Inclined Deck Height:</b>	43.7 cm (17.2 inches)
<b>Machine Weight:</b>	106.6 kg (235 lbs)

**Sound Emission:** Less than 70 db average without load. Noise emission under load is higher than without load.



DO NOT dispose of this product as refuse. This product is to be recycled. For proper disposal of this product, please follow the prescribed methods at an approved waste center.

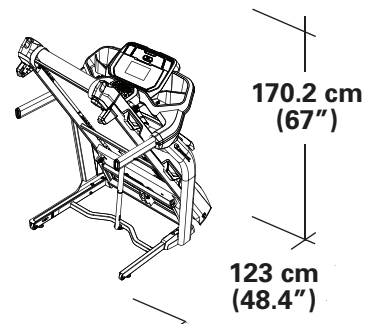
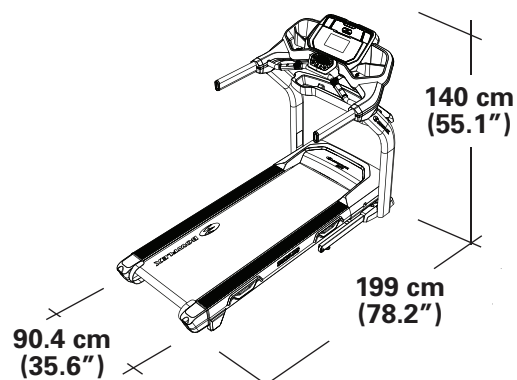

## Before Assembly

Select the area where you are going to set up and operate your machine. For safe operation, the location must be on a hard, level surface. Allow a minimum workout area of 212 cm x 400 cm (83.6" x 157.2"). Be sure that the workout space you are utilizing has adequate height clearance, taking into consideration the height of the user and the maximum incline of the machine.

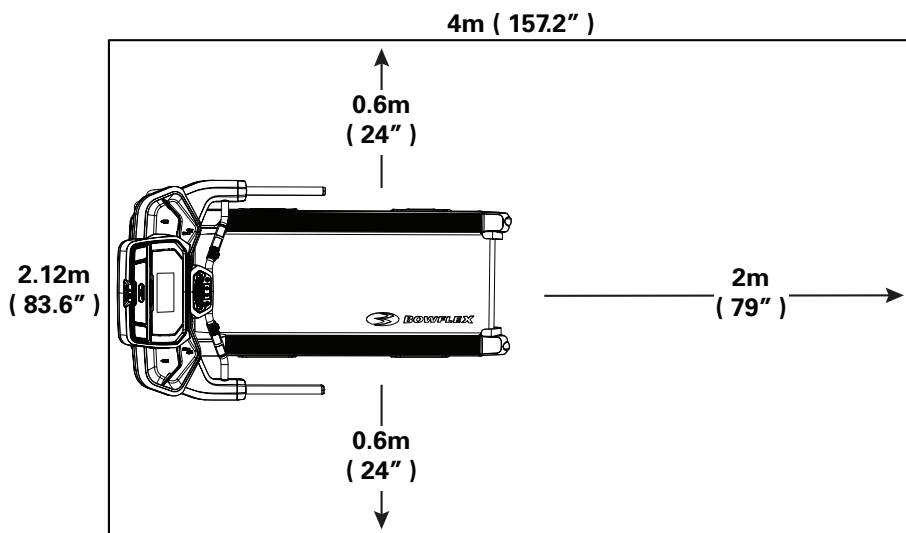

## Machine Mat

The Bowflex™ Machine Mat is an optional accessory that helps keep your workout area clear and adds a layer of protection to your floor. The rubber machine mat provides a non-slip, rubber surface which limits static discharge and reduces the possibility of display errors. If possible, put your Bowflex™ Machine Mat in your selected workout area before you begin assembly.

To order the optional machine mat, contact Customer Service (if purchased in US/Canada) or your local distributor (if purchased outside US/Canada).



## Grounding Instructions (for a 120V AC system)

This product must be grounded. If it should malfunction or break down, grounding provides a path of least resistance for electric current to reduce the risk of electric shock. This product is equipped with a cord having an equipment-grounding conductor and a grounding plug. The plug must be plugged into an appropriate outlet that is properly installed and grounded in accordance with all local codes and ordinances.

**⚠ DANGER** Improper connection of the equipment-grounding conductor can result in a risk of electric shock. Check with a qualified electrician or service person if you are in doubt as to whether the product is properly grounded. Do not modify the plug provided with the product – if it will not fit the outlet, have a proper outlet installed by a qualified electrician.

If you connect the machine to an outlet with GFI (ground fault interrupt) or AFI (arc fault interrupt), machine operation can cause the circuit to trip.

**⚠** This machine is for use on a nominal 120-V circuit, and has a grounding plug that looks like the plug illustrated below. A temporary adapter that looks like the adapter illustrated may be used to connect this plug to a 2-pole receptacle as shown if a properly grounded outlet is not available.

The temporary adapter should be used only until a properly grounded outlet can be installed by a qualified electrician. The tab for the grounding screw must be connected to a permanent ground such as a properly grounded outlet box cover. Whenever the adapter is used, it must be held in place by a metal screw.

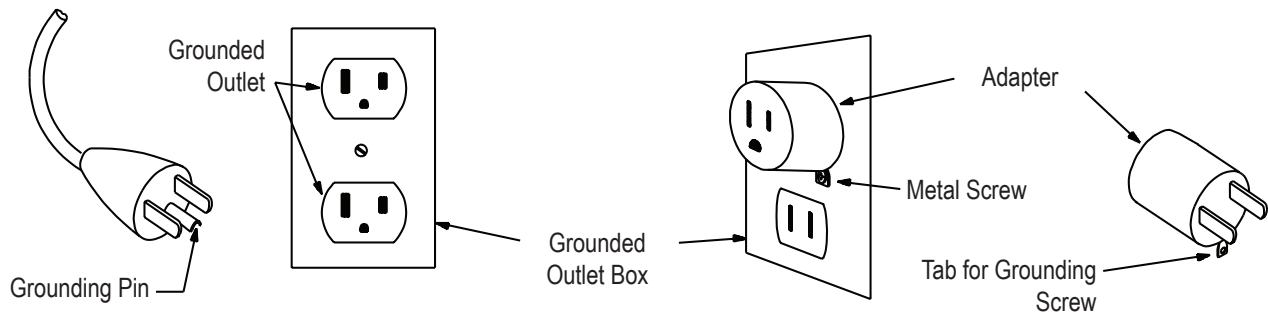

## Earthing Instructions (for a 220-240V AC system)

This product must be electrically earthed. If a malfunction occurs, correct earthing decreases the risk of electric shock. The power cord is equipped with an equipment-earthing conductor, and must be connected to an outlet that is properly installed and earthed.

**⚠ DANGER** The electrical wiring must comply with all applicable local and provincial standards and requirements. Incorrect connection of the equipment-earthing conductor can result in a risk of electric shock. Consult a licensed electrician if you are not sure that the machine is correctly earthed. Do not change the plug on the machine – if it does not fit the outlet, have a correct outlet installed by a licensed electrician.

If you connect the machine to an outlet with RCBO (Residual-Current circuit Breaker with Overload protection), machine operation can cause the circuit to trip. A Surge Protector Device is recommended to protect the machine.

**⚠** If a Surge Protector Device (SPD) is used with this machine, be sure that it matches the power rating of this equipment (220-240V AC). Do not connect other appliances or devices to the surge protector in combination with this machine.

**Make sure that the product is connected to an outlet having the same configuration as the plug. Use the appropriate adapter supplied with this product.**

## Emergency Stop Procedure

The Treadmill machine is equipped with a Safety Key that can prevent serious injury, as well as prevent children from playing with and/or being injured on the machine. If the Safety Key is not correctly inserted into the Safety Key Port, the belt will not operate.

** Always attach the Safety Key Clip to your clothing during your workout.**

**When you use the machine, only remove the Safety Key in an emergency. When the key is removed while the machine is in operation, it will stop quickly, which could cause the loss of balance and possible injury.**

**For safe storage of the machine, and to prevent unsupervised operation of the machine, always remove the Safety Key and disconnect the power cord from the wall outlet and the AC input. Place the power cord in a secure location.**

The Console will display “ + SAFETY KEY ”, or add Safety Key, for a Safety Key fault. The Treadmill machine will not start a Workout, or will end and clear an active Workout, when the Safety Key is removed. Inspect the Safety Key and be sure it is connected to the Console correctly.

## Moving and Storing the Machine

**!** The machine can be moved by one or more persons. Use caution when you move the machine. The treadmill is heavy and can be awkward. Make sure that your own physical strength is capable of moving the machine. Use a second person if necessary.

1. Before the machine can be moved, inspect the Walking Deck to be sure the Incline setting is at “1”. If necessary, adjust the Incline setting to “1”.

**!** Be sure the area below the machine is clear before adjusting the incline of the Deck. Fully lower the incline of the Deck after each workout.

2. Remove the Safety Key and place it in a secure location.

**!** When this machine is not in operation, remove the Safety Key and keep out of the reach of children.

3. Make sure that the power switch is turned Off, and the power cord is disconnected.

4. You must fold the treadmill before you move it. Never move the treadmill if it is not folded.

**!** Never move the machine with the Walking Deck not folded. Rotating or moving parts can pinch, resulting in personal injury.

5. Make sure that there is safe clearance around, on and above your treadmill. Make sure there is no object to spill or cause blockage from the fully folded position.

**!** Be sure there is adequate height clearance for the raised deck.

6. Using the support bar found below the rear of the walking belt, lift the walking deck fully upward and engage the hydraulic lift. Be sure that the hydraulic lift is correctly locked in place. You will hear an audible click when the hydraulic lift shifts into the locked position.

**!** Use proper safety precautions and lifting techniques. Bend your knees and elbows, keep your back straight and pull up equally with both arms. Straighten your legs to lift. Make sure that your own physical strength is capable of lifting the walking deck until it engages the locking mechanism. Use a second person if necessary.

Do not use the walking belt or rear roller to lift the treadmill. These parts do not lock in place and can abruptly move. Injury to you or damage to the machine can occur.

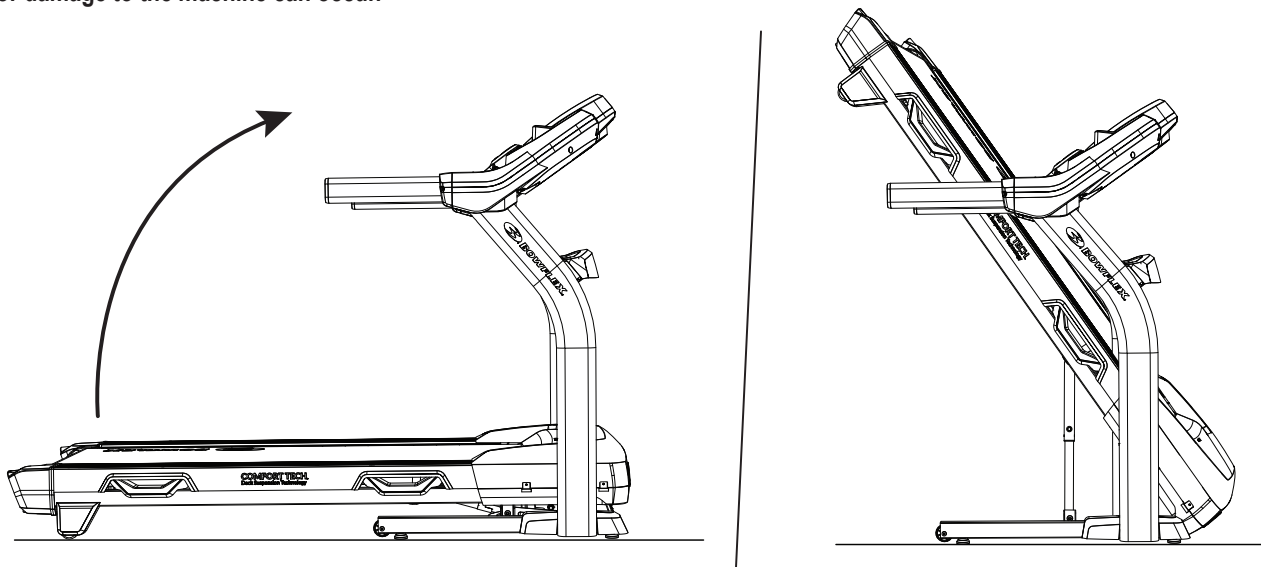

7. Make sure that the locking mechanism is engaged. Carefully pull back on the walking deck and make sure that it does not move. When you do this, keep clear of movement path in case the treadmill lock is not properly engaged.

**!** Do not lean against the treadmill when it is folded. Do not put items on it that could cause it to become unstable or fall.

Do not connect the power cord or try to operate the treadmill in the folded position.

8. Stand to one side of the treadmill. Place your front foot so it pins the Base Assembly. Grasping the Side Handrail, carefully pivot the treadmill rearward until it is balanced fully on the transport wheels. Be sure not to pivot the machine too far. Hold the treadmill in the balanced position.

**!** This step may require two persons on each side of the treadmill. The treadmill is heavy and can be awkward. Make sure that your own physical strength is capable of pivoting the machine.

Always wear fully enclosed shoes when moving this machine. Do not move the machine with bare feet or only wearing socks.

Do not use the Console or lifted Walking Deck to pivot or move the treadmill. Injury to you or damage to the machine can occur.

Keep clear of the movement path of the lifted Walking Deck.

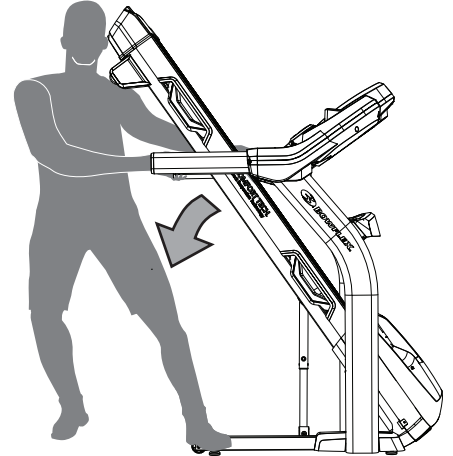

9. Grasping the Side Handrail and the front of the Upright, safely roll the treadmill to the desired location.

**!** The treadmill is heavy and can be awkward. Make sure that your own physical strength is capable of moving the machine.

Place the machine on a clean, hard, level surface, free from unwanted material or other objects that may hamper your ability to move freely. A rubber mat should be used below the machine to prevent the release of static electricity and protect your flooring.

Do not put objects in the path of the walking deck when lowered.

*NOTICE:* Move the machine carefully so that it does not hit other objects. This can damage the Console operation, the treadmill, or the area around the machine.

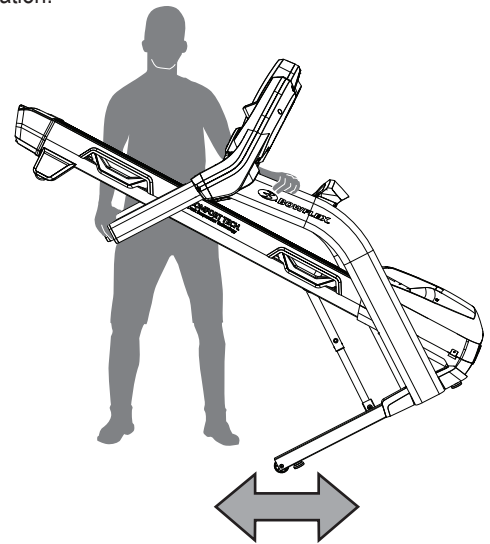

10. Prior to use, refer to the “Unfolding the Machine” procedure in this manual.

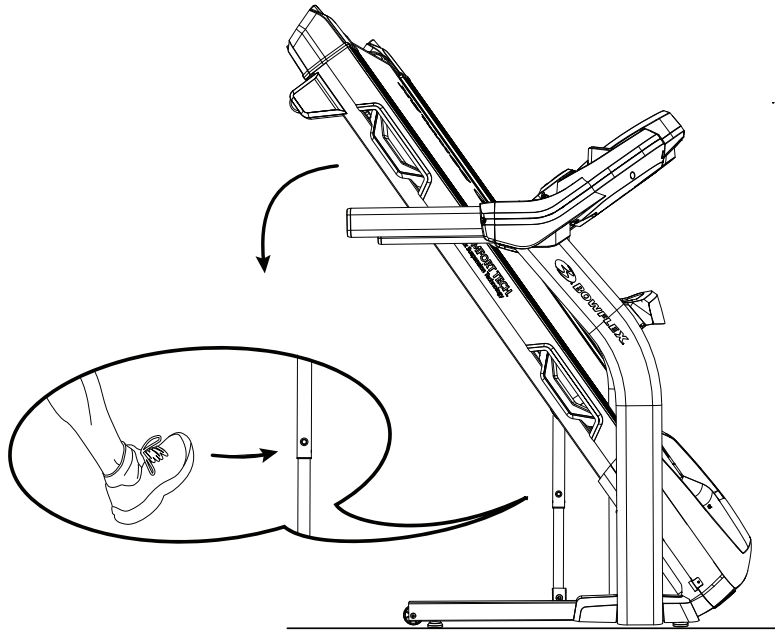

## Unfolding the Machine

1. Make sure there is sufficient space to lower the walking deck.

**!** Keep a minimum clearance behind the machine of 2 m (79") and 0.6 m (24") on each side. This is the recommended safe distance for access, movement and emergency dismounts from the machine.

Place the machine on a clean, hard, level surface, free from unwanted material or other objects that may hamper your ability to move freely with a sufficient clear workout area. A rubber mat below the machine is recommended to prevent electrostatic discharge and protect your floor.

Be sure that the workout space you are utilizing has adequate height clearance, taking into consideration the height of the user and the maximum incline of the deck.

2. Make sure there is no object on or around the treadmill to spill or cause blockage from the fully unfolded position.
3. Slightly push the walking deck forward toward the console. With your left foot lightly push the top part of the hydraulic lift forward until the locking tube releases and you can pull the walking deck away from the console. Hold up the rear of the walking deck, and move to the side of the machine.

**!** Keep clear of the movement path of the walking deck.

4. The hydraulic lift is set up to drop lightly. Hold onto the walking deck until approximately 2/3 of the movement down. Lower the weight with your legs. The walking deck can possibly drop quickly in the last part of the movement.

## Leveling the Machine

The machine needs to be leveled if your workout area is uneven. To adjust:

1. Place the machine in your workout area.
2. Adjust the levelers until they all contact the floor.

**⚠ Do not adjust the levelers to such a height that they detach or unscrew from the machine. Injury to you or damage to the machine can occur.**

3. Adjust until the machine is level.

Make sure the machine is level and stable before you exercise.

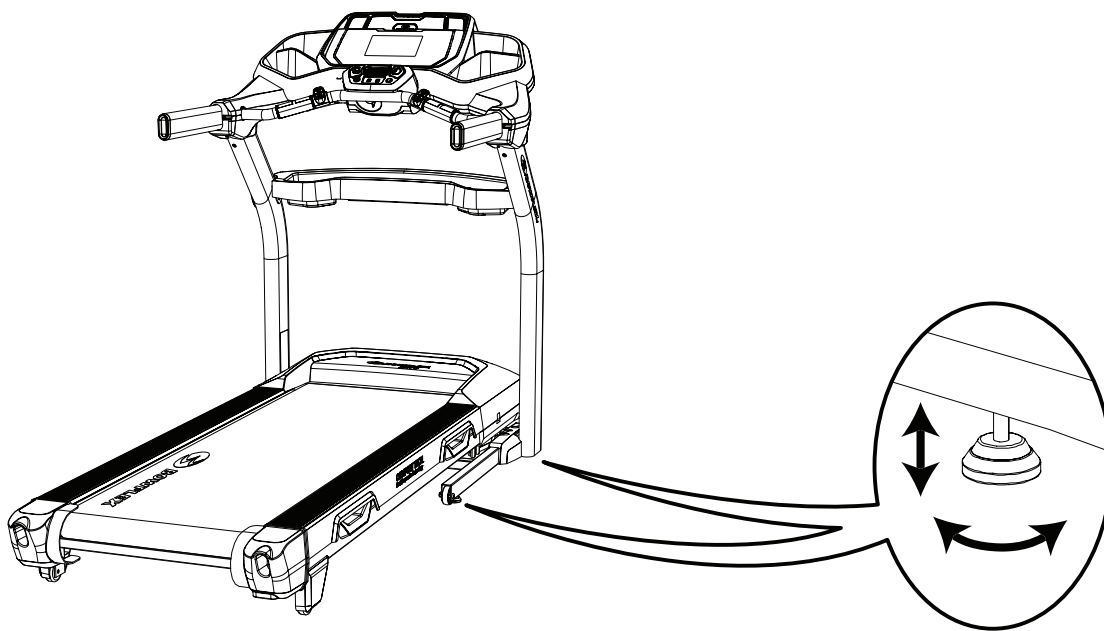

## Treadmill Belt

Your treadmill comes equipped with a durable, high quality walking belt designed to provide many hours of reliable service. The walking belt on a treadmill that has not been operated for a length of time, either in factory packaging or after assembly, can exhibit a “thumping” noise when started. This is due to the belt taking on the curve of the front and rear rollers. This is a common occurrence and does not indicate a problem with your machine. After the treadmill has been used for a short period of time the thumping noise will discontinue. The amount of time will vary depending on the temperature and humidity of the environment where the treadmill is placed.

## **CONNECTIVITY**

### **Workout with Other Fitness Apps**

This fitness machine has integrated Bluetooth® connectivity which allows it to work with a number of digital partners. For our latest list of supported partners, please visit: [www.nutilus.com/partners](http://www.nutilus.com/partners)

### **USB Charging**

If a USB Device is attached to the USB Port, the Port will attempt to charge the Device. The power supplied from the USB Port may not be enough to operate the Device and charge it at the same time.



# MAINTENANCE

Read all maintenance instructions fully before you start any repair work. In some conditions, an assistant is required to do the necessary tasks.

**⚠** Equipment must be regularly examined for damage and repairs. The owner is responsible to make sure that regular maintenance is done. Worn or damaged components must be repaired or replaced immediately. Only manufacturer supplied components can be used to maintain and repair the equipment.

If at any time the Warning labels become loose, unreadable or dislodged, replace the labels. If purchased in US/Canada, contact Customer Service for replacement labels. If purchased outside US/Canada, contact your local distributor for them.

**⚠ DANGER** To reduce the risk of electrical shock or unsupervised usage of the equipment, always unplug the power cord from the wall outlet and the machine and wait 5 minutes before cleaning, maintaining or repairing the machine. Place the power cord in a secure location.

**Daily:** Before each use, examine the exercise machine for loose, broken, damaged, or worn parts. Do not use if found in this condition. Repair or replace all parts at the first sign of wear or damage, except for the Walking Deck. The Walking Deck is designed for wear on both sides of it. If only one side of the Walking Deck is worn, a replacement Deck is not required. It is recommended that a qualified service technician is used to flip the Walking Deck. After each workout, use a damp cloth to wipe your machine and Console free of moisture.

**Note:** Avoid excessive moisture on the Console.

**Weekly:** Check for smooth roller operation. Wipe the machine to remove dust, dirt, or grime.

**⚠** Do not remove the Motor Control Board (MCB) Cover, as dangerous voltages and moving parts are present. The components are serviceable only by approved service personnel or by following service procedures supplied by Nautilus, Inc.

**Note:** Do not use petroleum based products.

**Monthly or after 20 hours:** Make sure all bolts and screws are tight. Tighten as necessary.

**Quarterly:** Or after 25 hours—Lubricate the walking belt with a 100% pure silicone lubricant.

**⚠** Silicone lubricant is not intended for human consumption. Keep out of reach of children. Store in a safe place.

**Note:** Do not use petroleum based products.

## Cleaning

**⚠ DANGER** To reduce the risk of electrical shock, always unplug the power cord and wait 5 minutes before cleaning, maintaining or repairing this machine.

Wipe the treadmill down after each use to keep the treadmill clean and dry. It may be necessary to use a mild dish soap at times to remove all dirt and salt from the belt, painted parts and the display.

**NOTICE:** If necessary, only use a mild dish soap with a soft cloth to clean the Console. Do not clean with a petroleum based solvent, automotive cleaner, or any product that contains ammonia. Do not clean the Console in direct sunlight or at high temperatures. Do not apply too much moisture to the Console.

## Adjusting the Belt Tension

If the walking belt starts to slip during use, it is necessary to adjust the tension. Your treadmill has tension bolts at the rear of the treadmill.

1. Remove the Safety Key and place it in a secure location.

**!** When this machine is not in operation, remove the Safety Key and keep out of the reach of children.

2. Make sure that the power switch is turned Off, and the power cord is disconnected.
3. Use a 6 mm hex wrench to turn the right and left belt adjustment bolts clockwise a 1/2 turn, first one bolt and then the other bolt.
4. After you adjust each side the 1/2 turn, inspect the walking belt. From the belt's midpoint, a correctly tensioned belt should only have an inch of give. To check, pull the belt upward at its midpoint and measure the distance to the deck. If the distance is more than an inch, the belt is loose. Repeat this step if necessary.

If you turn one side more than the other, the belt will move away from that side of the treadmill and may need realignment.

**NOTICE:** Too much tension on the belt causes unnecessary friction and wears the belt, motor and electronics.

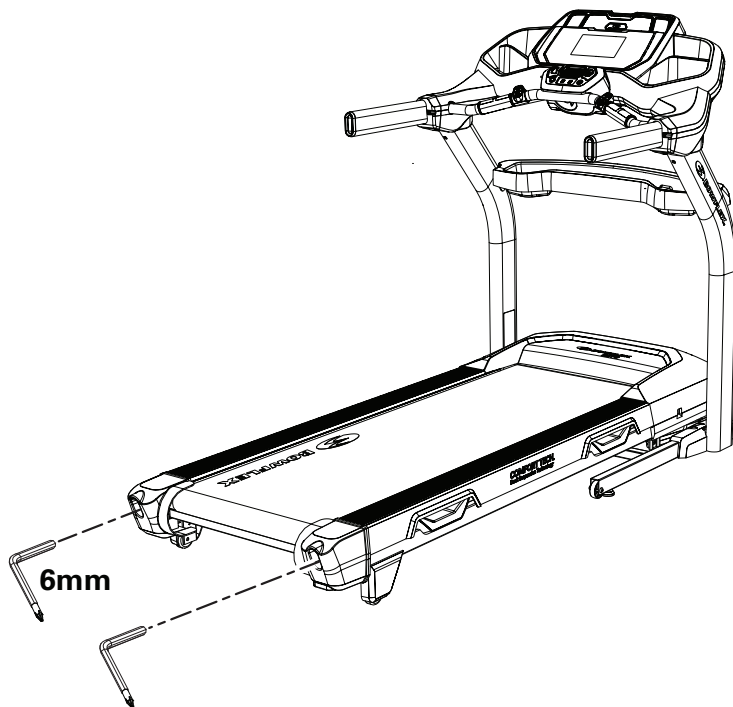

## Aligning the Walking Belt

The walking belt should be centered on your treadmill at all times. Running style and a non-level surface can cause the belt to move off center. Minor adjustments to the 2 bolts at the rear of the treadmill are necessary when the belt is off center.

1. Push the START button to start the walking belt.

**!** Be sure not to touch the walking belt or step on the power cord. Keep bystanders and children away from the product you are servicing at all times.

2. Stand at the rear of the treadmill to see which direction the belt moves.
3. If the belt moves to the left, turn the left belt adjustment bolt 1/4 turn clockwise and the right belt adjustment bolt 1/4 turn counterclockwise.  
If the belt moves to the right, turn the left adjustment bolt 1/4 turn counterclockwise and the right adjustment bolt 1/4 turn clockwise.
4. Monitor the path of the belt for approximately 2 minutes. Continue to adjust the bolts until the walking belt is centered.
5. Push PAUSE/STOP twice to stop the walking belt and end the Quick Start workout.

## Lubricating the Walking Belt

Your treadmill is equipped with a low maintenance deck and belt system. The Walking Belt is pre-lubricated. Belt friction can affect the function and life of the machine. Lubricate the belt every 3 months or every 25 hours of use, whichever comes first. Even if the treadmill is not in use, silicone will dissipate and the belt will dry out. For the best results, lubricate the deck periodically with a silicone lubricant using the following instructions:

1. Turn off the power to the machine with the power switch.
2. Unplug the treadmill fully from the wall outlet, and remove the power cord from the machine.

**⚠ DANGER** To reduce the risk of electrical shock, always unplug the power cord and wait 5 minutes before cleaning, maintaining or repairing this machine. Place the power cord in a secure location.

3. Inspect the surface material below the Treadmill. If the surface material is difficult to clean or could be damaged by silicone lubricant, place absorbent material (such as cardboard or newspaper) below the length of the Walking Deck.
4. Apply a few drops of the lubricant on the deck below the belt. Carefully lift the belt and apply a few drops of the lubricant the entire width of the belt. A very thin layer of silicone lubricant on the entire deck below the belt is desired.

**NOTICE:** Always use a 100% pure silicone lubricant. Do not use a degreaser like WD-40® as this could seriously impact performance. We can recommend that you use the following:

- 100% pure silicone, available at most hardware and auto parts stores.
- Lube-N-Walk® Treadmill Lubrication Kit, available from your local specialty fitness dealer or Nautilus, Inc.

**⚠** Silicone lubricant is not intended for human consumption. Keep out of reach of children. Store in a safe place.

5. Manually rotate the belt 1/2 of the length of the belt and apply lubricant again.

**⚠** If you used spray lubricant, wait 5 minutes before turning on power to the machine to allow the aerosol to dissipate.

6. Connect the power cord back into the machine and then into the wall outlet.
7. Turn on the power to the machine with the power switch.
8. Stay to one side of your machine and start the belt at the slowest speed. Let the belt operate for approximately 15 seconds.

**⚠** Be sure not to touch the walking belt or step on the power cord. Keep bystanders and children away from the product you are servicing at all times.

9. Switch off your machine.
10. Take care to clean up any excess lubricant from the deck.

**⚠** To decrease the possibility of slipping, be sure the deck area is free from grease or oil. Clean off any excess oil from the machine surfaces.

As you use your fitness machine, the Console will show "LUBRICATE BELT" followed by "REVIEW USER MANUAL" at set times. This is only a reminder and should be added to your inspection schedule. Only apply lubricant as necessary. Push any button to accept the reminder.

## Replace Batteries in Chest Strap

The heart rate (HR) chest strap uses a CR2032 battery.

**⚠ Do not perform this procedure outdoors or in moist or wet locations.**

1. Using a coin, loosen the slotted cover on the battery bay. Remove the cover and battery.
2. When replacing the battery, insert it in the battery bay with the + symbol facing up.

**Note:** The chest strap uses CR2032 size batteries.

3. Reinstall the cover on the strap.
4. Discard the old battery. Dispose of in accordance with local regulations and/or at approved recycling centers.
5. Inspect your chest strap to ensure function.

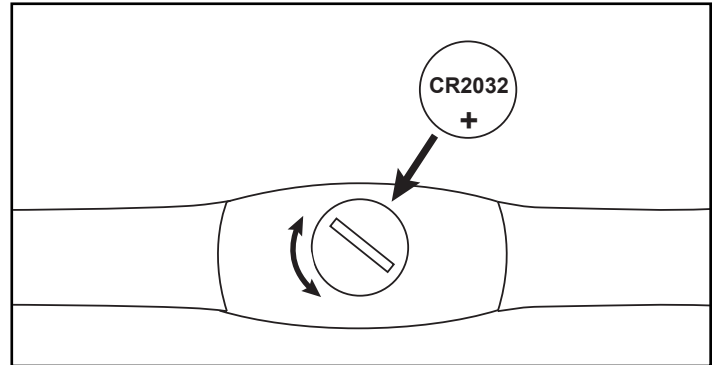

**⚠ Do not use until the equipment has been fully assembled and inspected for correct performance in accordance with the Owner's Manual.**

# Maintenance Parts

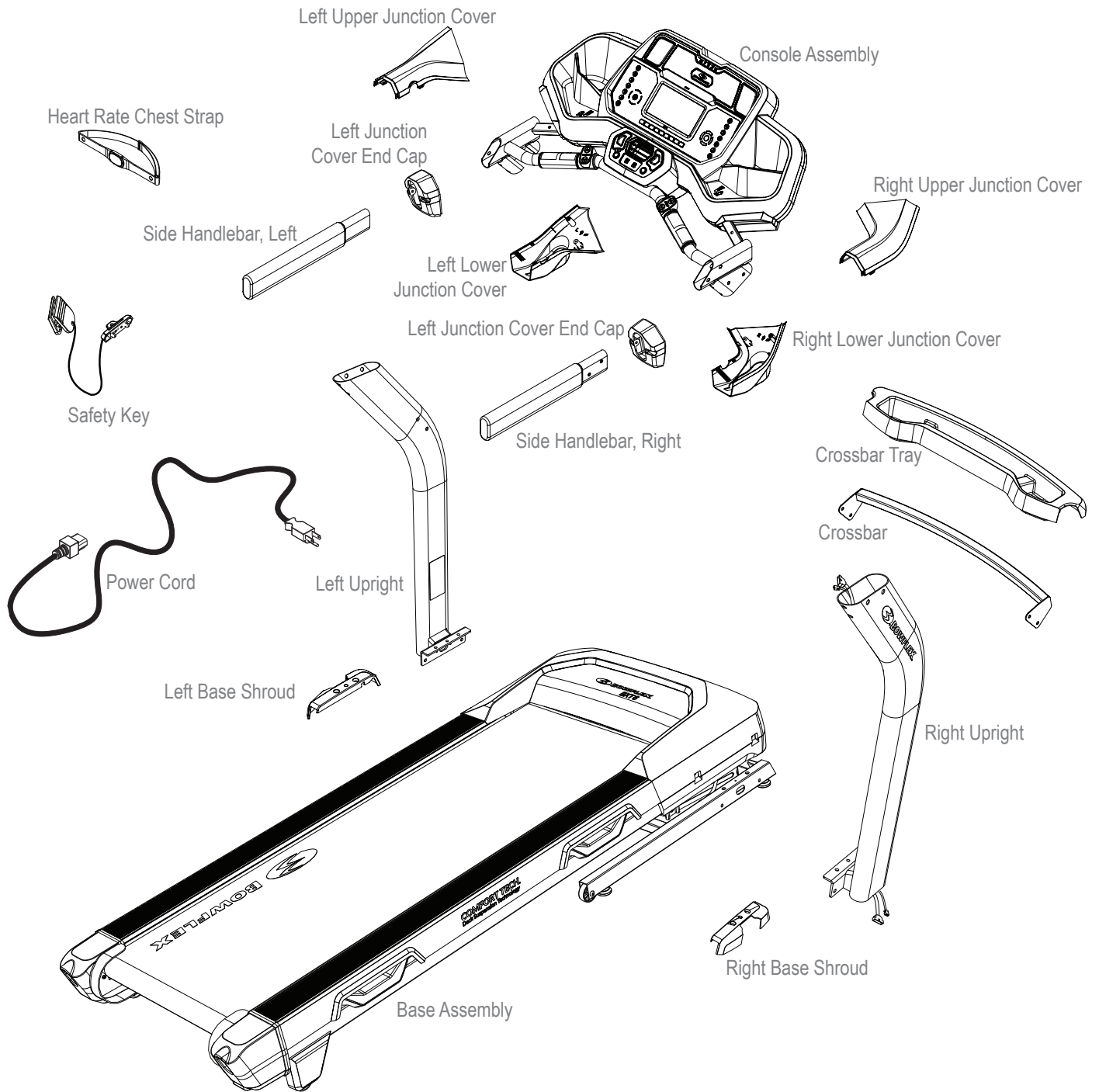

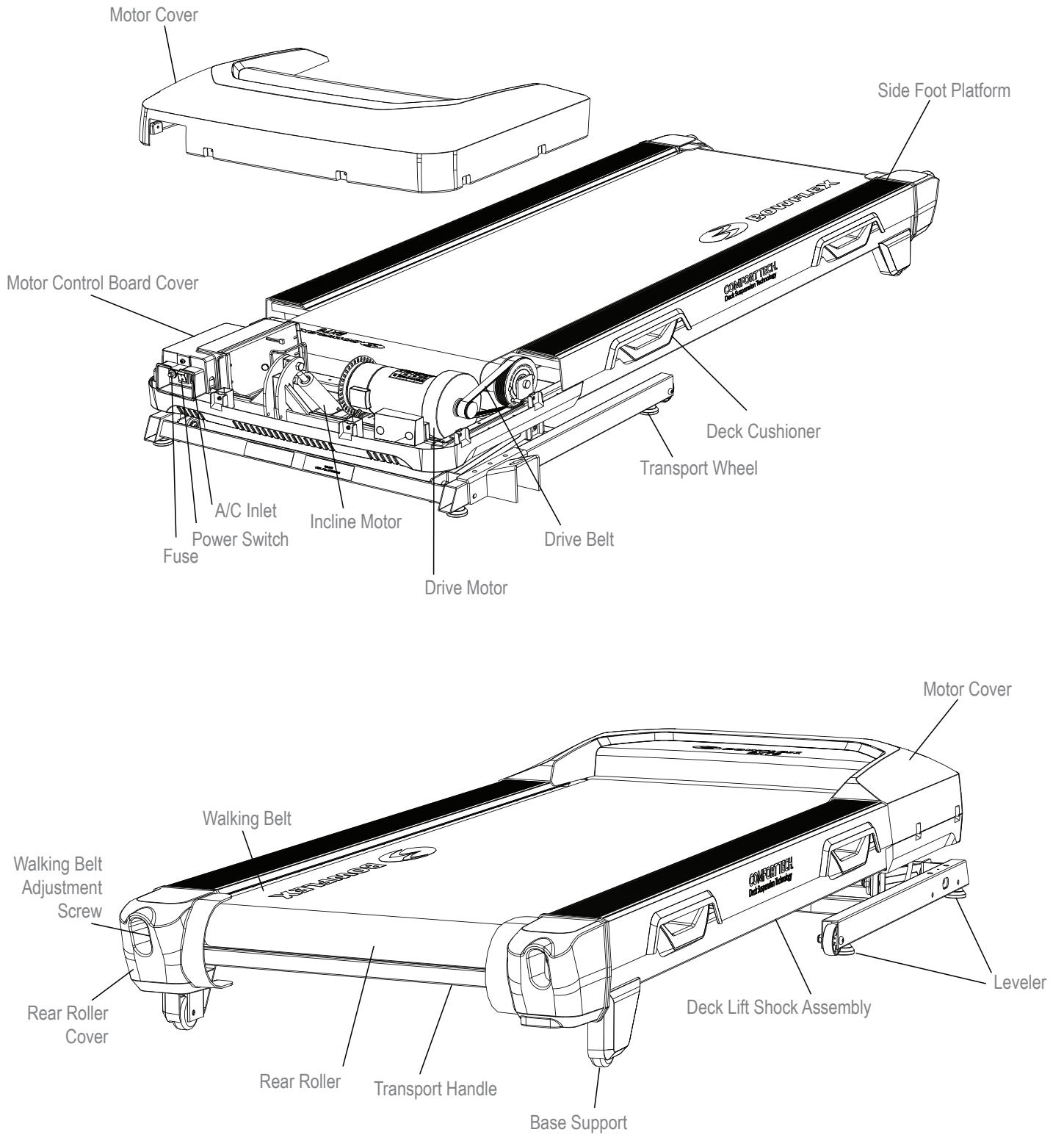

## Service Mode Procedures

### PROCEDURE 1: MCB COMMUNICATIONS TEST (I/O CABLE TEST):

1. Hold down the PAUSE/STOP button and Down(▼) arrow button together for three seconds while at the Welcome screen to enter the Console Setup Mode.
2. The Console displays the TOTAL HOURS screen.
3. Hold down the PAUSE/STOP button and Down(▼) arrow button together for 3 seconds to go into the Engineering Mode.
4. Press the Down(▼) arrow button 11 times and screen will display ENTR MCB TEST.
5. Press ENTER to begin the test.
6. The Console will display either MCB PASS or MCB FAIL.
7. If the test results in a fail, I/O communications are interrupted and both I/O cables must be replaced.  
RETURN DEFECTIVE CABLES TO NAUTILUS ATTN: QUALITY

### PROCEDURE 2: CHECK FIRMWARE VERSION AND ERROR LOG:

1. Hold down the PAUSE/STOP button and Down(▼) arrow button together for 3 seconds while at the Welcome screen to enter the Console Setup Mode.
2. The Console displays the TOTAL HOURS screen.
3. Push the Right(▶) arrow button to show the Console Firmware Version.
4. Record the code.
5. Push the Right(▶) arrow button four times.
6. The Console display shows "VIEW ERROR MSG NO" prompt.
7. Push the Up arrow button. The Console will display the "VIEW ERROR MSG YES" prompt.
8. The Console display shows "ERROR LOG VER2". Push ENTER to access the log.
9. Push the Right(▶) arrow button and record the code shown.
10. Push the Right(▶) arrow button again and record the next code.
11. If you have recorded all the numbers, push the ENTER button and screen will display "ERROR LOG RESET YES". Push Enter.
12. Press PAUSE/STOP to return to Welcome screen.

### PROCEDURE 3: RESET MACHINE (workout data will be lost):

1. Hold down the PAUSE/STOP button and Down(▼) arrow button together for 3 seconds while at the Welcome screen to enter the Console Setup Mode.
2. The Console displays the TOTAL HOURS screen.
3. Push the Right(▶) arrow button six times until the Console display shows the "RESET CONSOLE NO" prompt.
4. Press the Up(▲) arrow button and the screen will display RESET CONSOLE YES.
5. Push the ENTER button.
6. Turn the machine off when the Console displays the "POWER CYCLE NOW".

### PROCEDURE 4: CALIBRATE MCB:

1. Hold down the PAUSE/STOP button and Down(▼) arrow button together for three seconds while at the Welcome screen to enter the Console Setup Mode.
2. The Console displays the TOTAL HOURS screen.
3. Hold down the PAUSE/STOP button and Down(▼) arrow button together for 3 seconds to go into the Engineering Mode.
4. Push the Down(▼) arrow button 12 times until the Console displays "ENTR MCB CLB". Be sure the area around the Treadmill is clear of all bystanders, children and pets. Be sure there is nothing on or under the Walking Belt, or near the Treadmill.
5. The Console displays ENTR MCB CLB.
6. With the area clear, push the ENTER button. After a pause, the calibration procedure will begin by automatically moving the Walking Belt. Be sure not to touch or allow anyone else to touch the machine while calibration is occurring.
7. When calibration is complete, the Console will display "DONE". Push the PAUSE/STOP button twice.
8. Flip the power switch to OFF. Calibration is now complete for the machine.



**PROCEDURE 5: BUTTON (or KEY) TEST:**

1. Hold down the PAUSE/STOP button and Down(▼) arrow button together for three seconds while at the Welcome screen to enter the Console Setup Mode.
2. The Console displays the TOTAL HOURS screen.
3. Hold down the PAUSE/STOP button and Down(▼) arrow button together for 3 seconds to go into the Engineering Mode.
4. Push the Down(▼) arrow button 8 times until the Console displays “ENTR KEY TEST”.
5. Push the Enter button. The Console will display “BUTTON TEST”.
6. Using the guide below, push the corresponding button in the order provided. Continue through all the buttons.  
**Note:** If a faulted button is discovered, the Console may need to be powered down to exit the button test.
7. When the button test is complete, the Console will display “DONE”, followed by “BUTTON PASS”. Push the PAUSE/STOP button to return to Welcome screen.
8. Flip the power switch to OFF.

1	Incline 15	14	8 Minute Interval	27	Right Arrow
2	Incline 12	15	16 Minute Interval	28	Down Arrow
3	Incline 9	16	Strength	29	Left Arrow
4	Incline 6	17	Custom	30	Stop
5	Incline 3	18	Speed Confirm	31	Fan
6	Incline 1	19	Speed 1	32	Volume
7	Incline Confirm	20	Speed 3	33	Start
8	User	21	Speed 6	34	Incline +
9	Manual	22	Speed 9	35	Incline -
10	Fat Burn	23	Speed 10	36	Speed +
11	Calorie Burn	24	Speed 12	37	Speed -
12	Calorie Goal	25	Up Arrow	38	
13	Heart Rate	26	Enter	39	

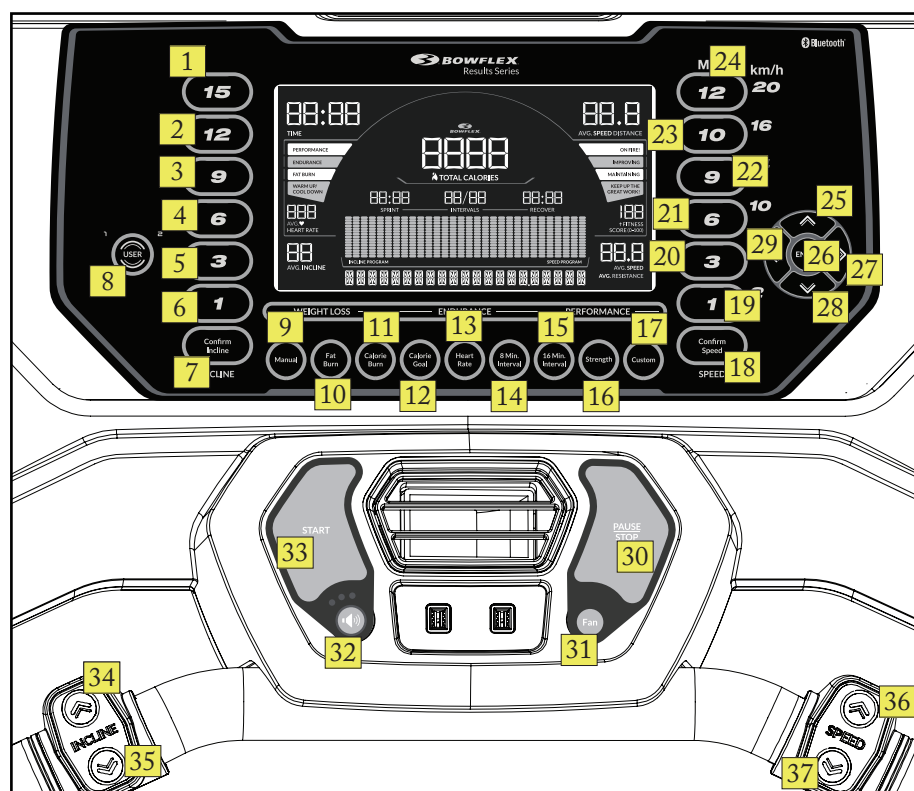

Unit will not power on, or power is on but Console does not light up

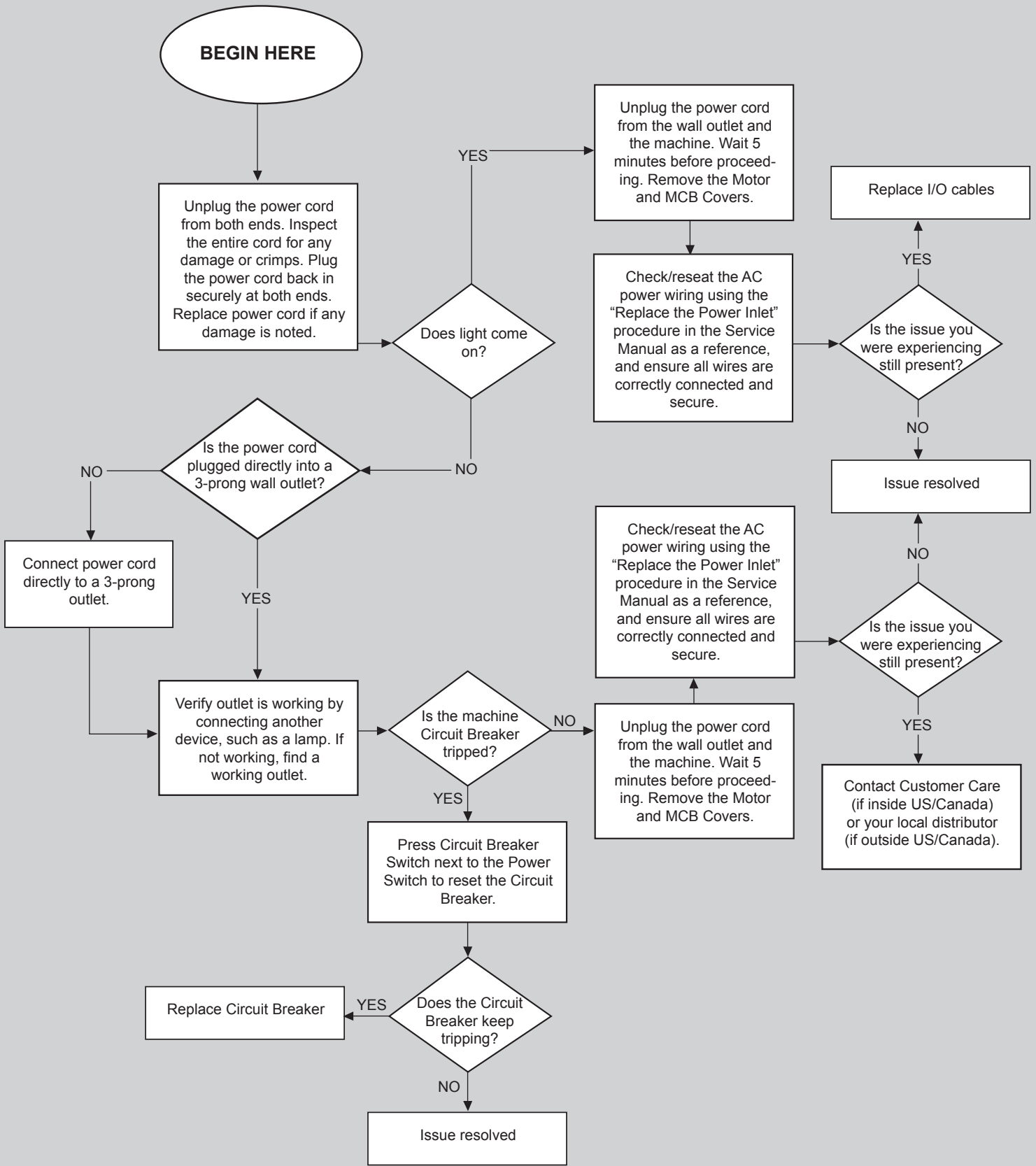

# Noise Issues

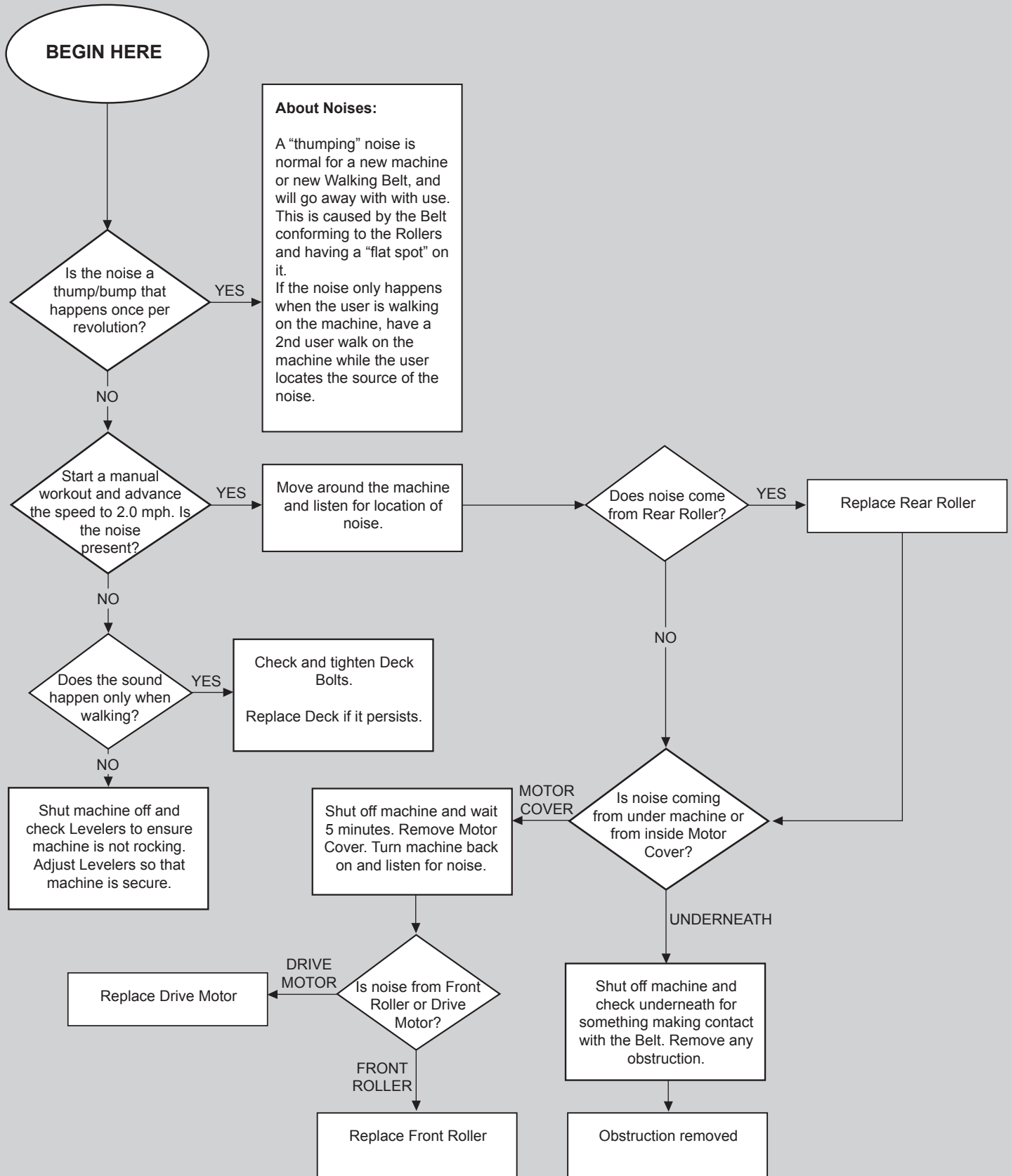

# Machine Shuts Off or Belt Stops During Workout

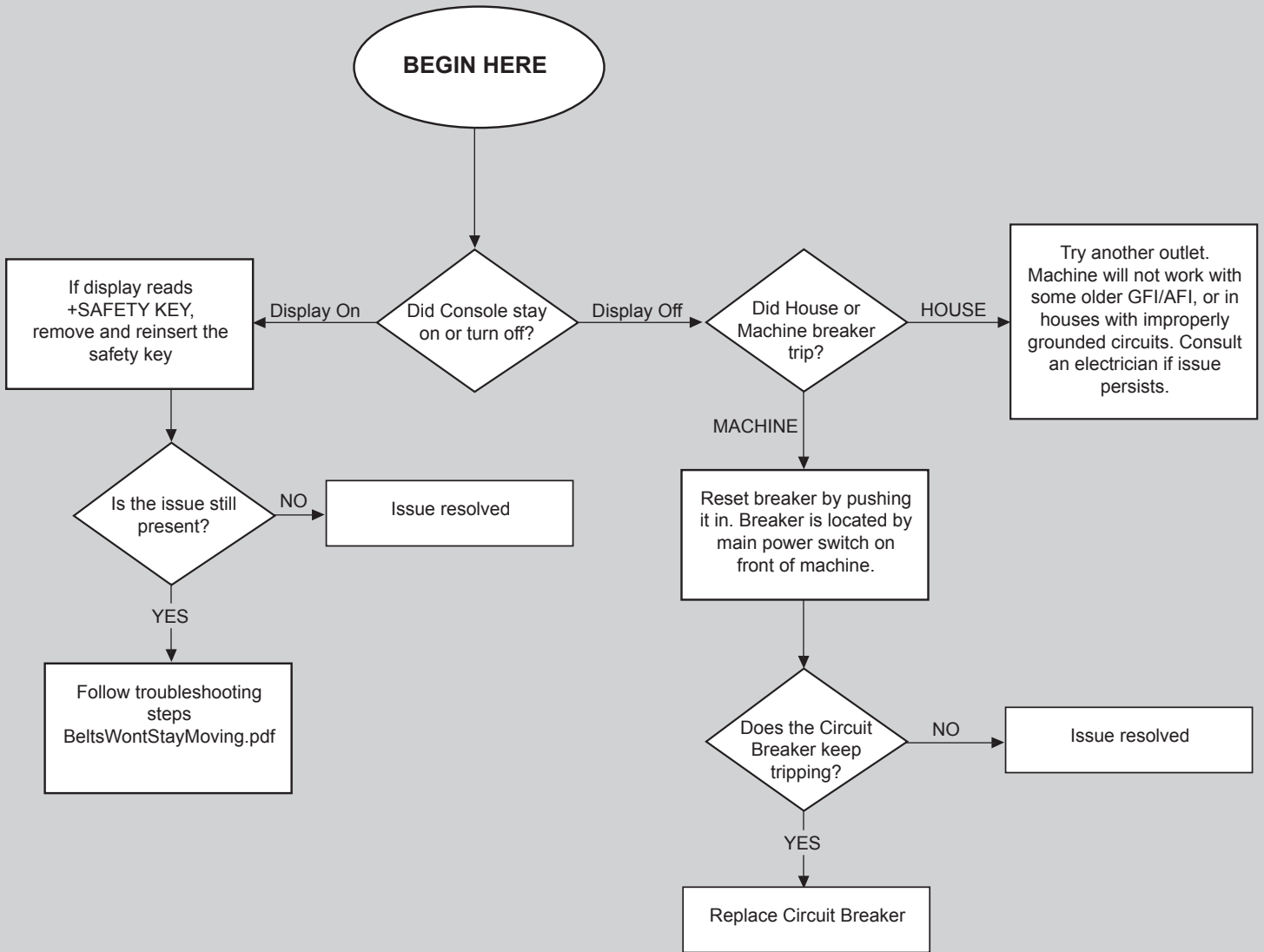

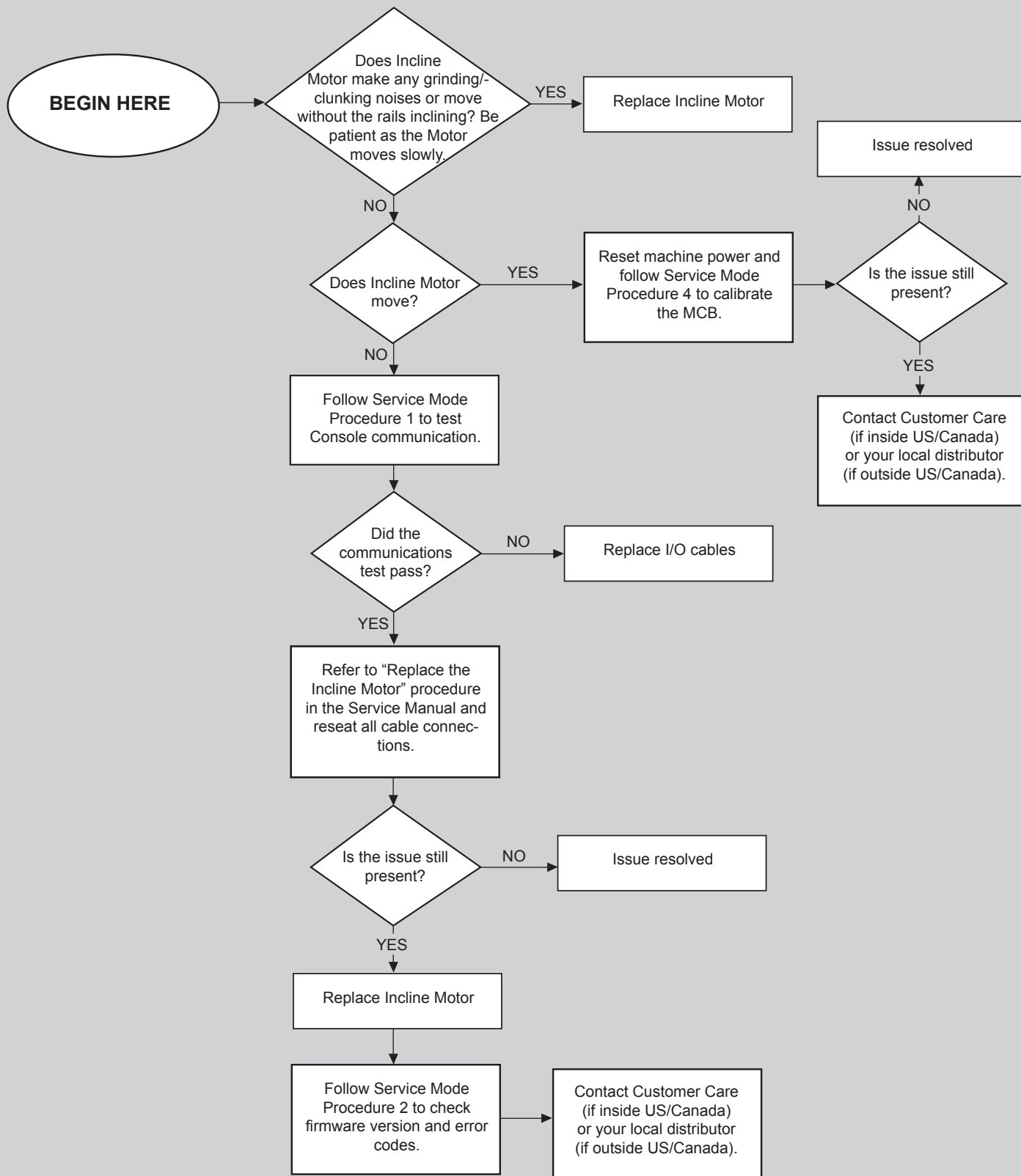

## Heart Rate Issues

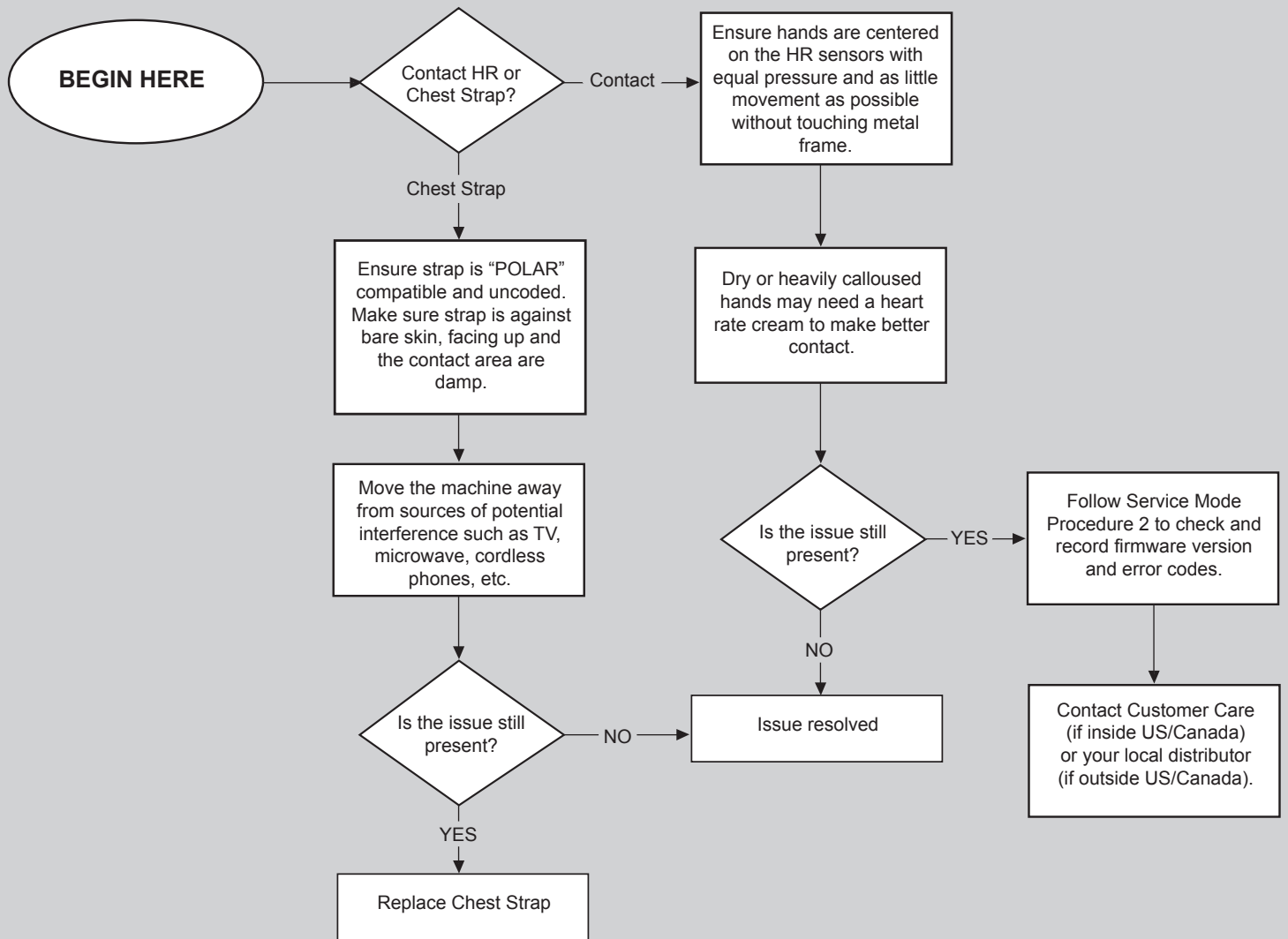

**BEGIN HERE:**

If Console will not light up, follow "Unit will not power on" Troubleshooting Procedure.  
 If the units of measure are incorrect, follow the Owner's Manual instructions to correct the setting before beginning these steps.

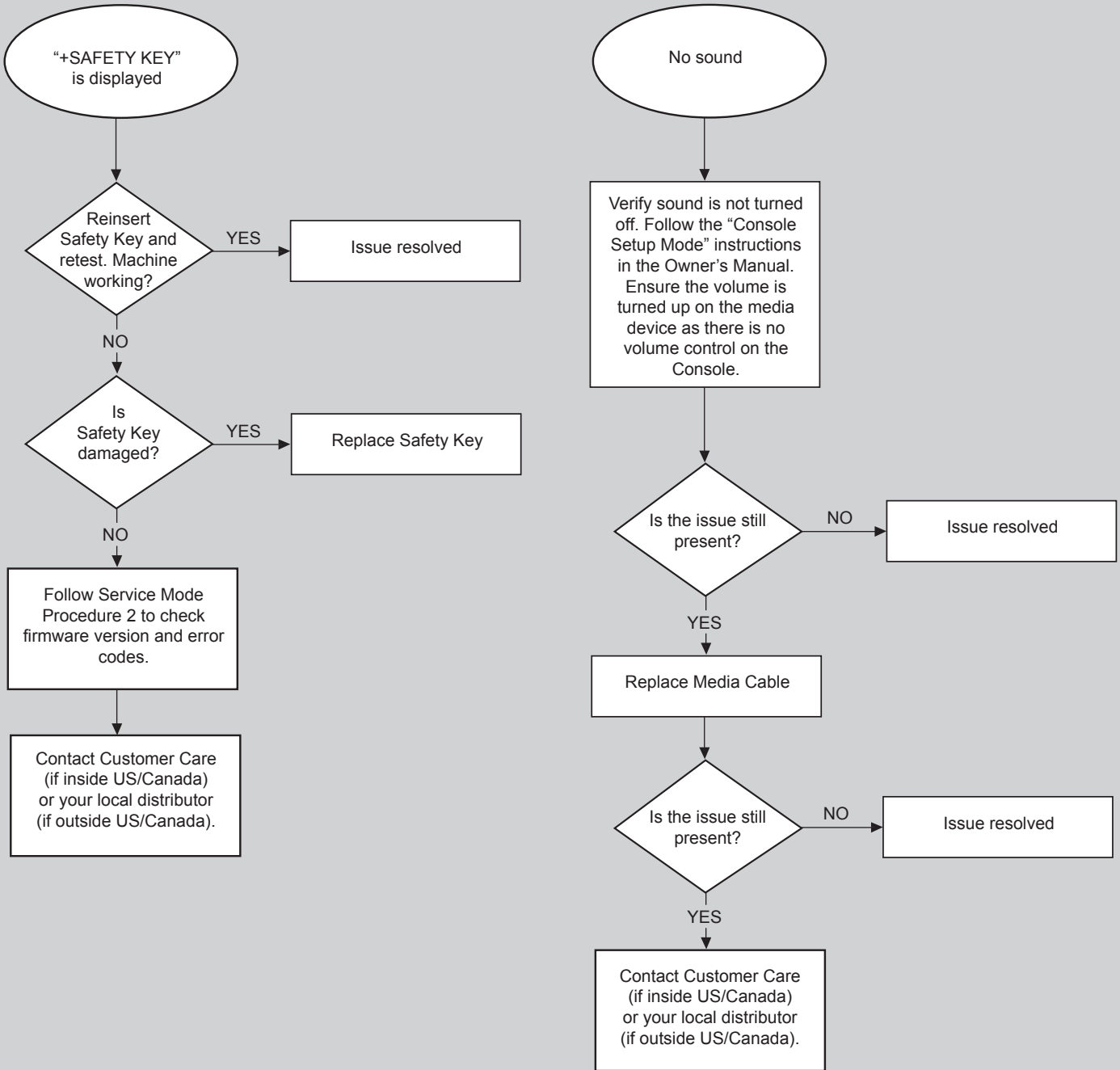



**BEGIN HERE:** If Console will not light up, follow "Unit will not power on" Troubleshooting Procedure.  
If the units of measure are incorrect, follow the Owner's Manual instructions to correct the setting before beginning these steps.

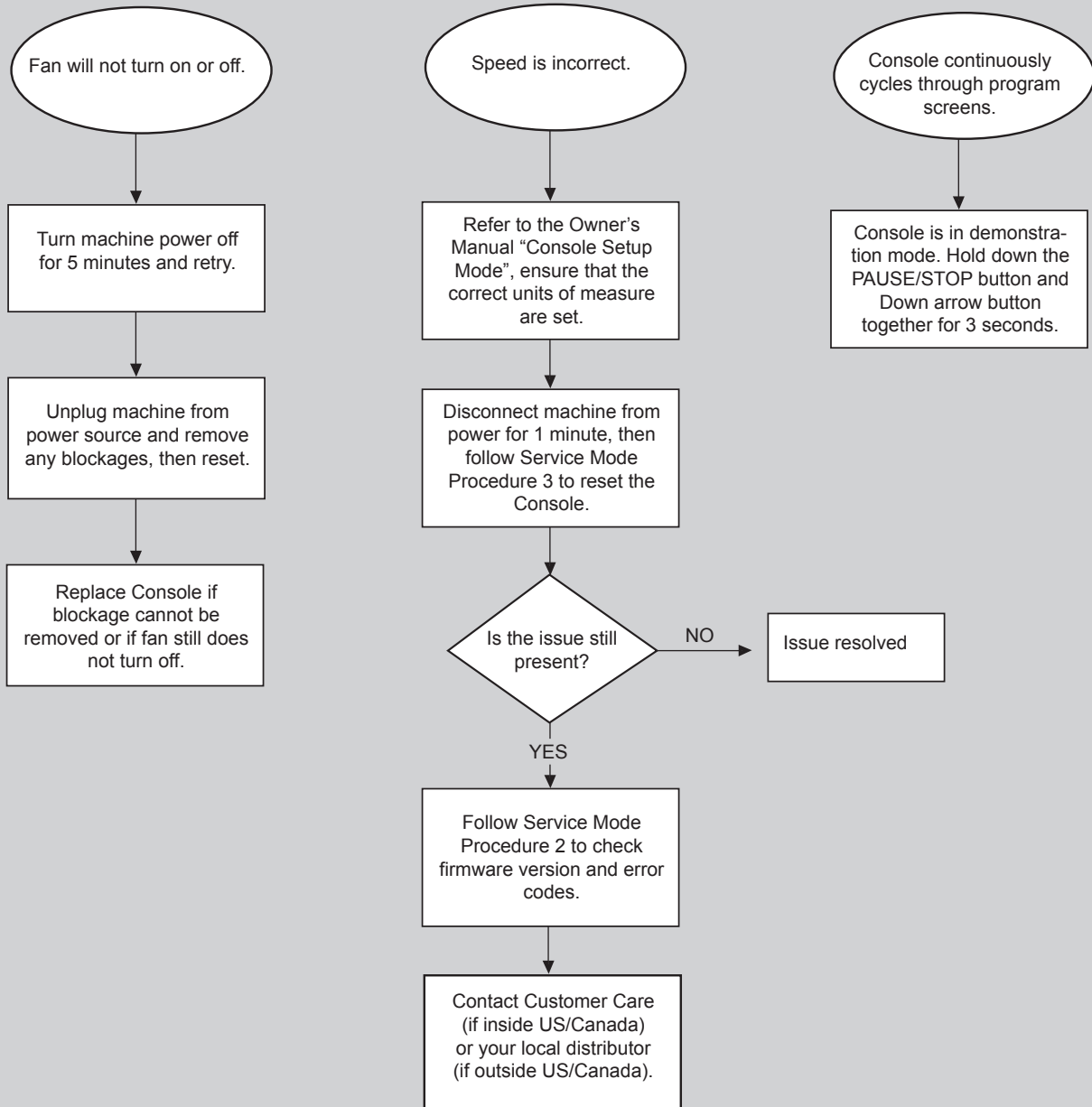

## Buttons Do Not Respond

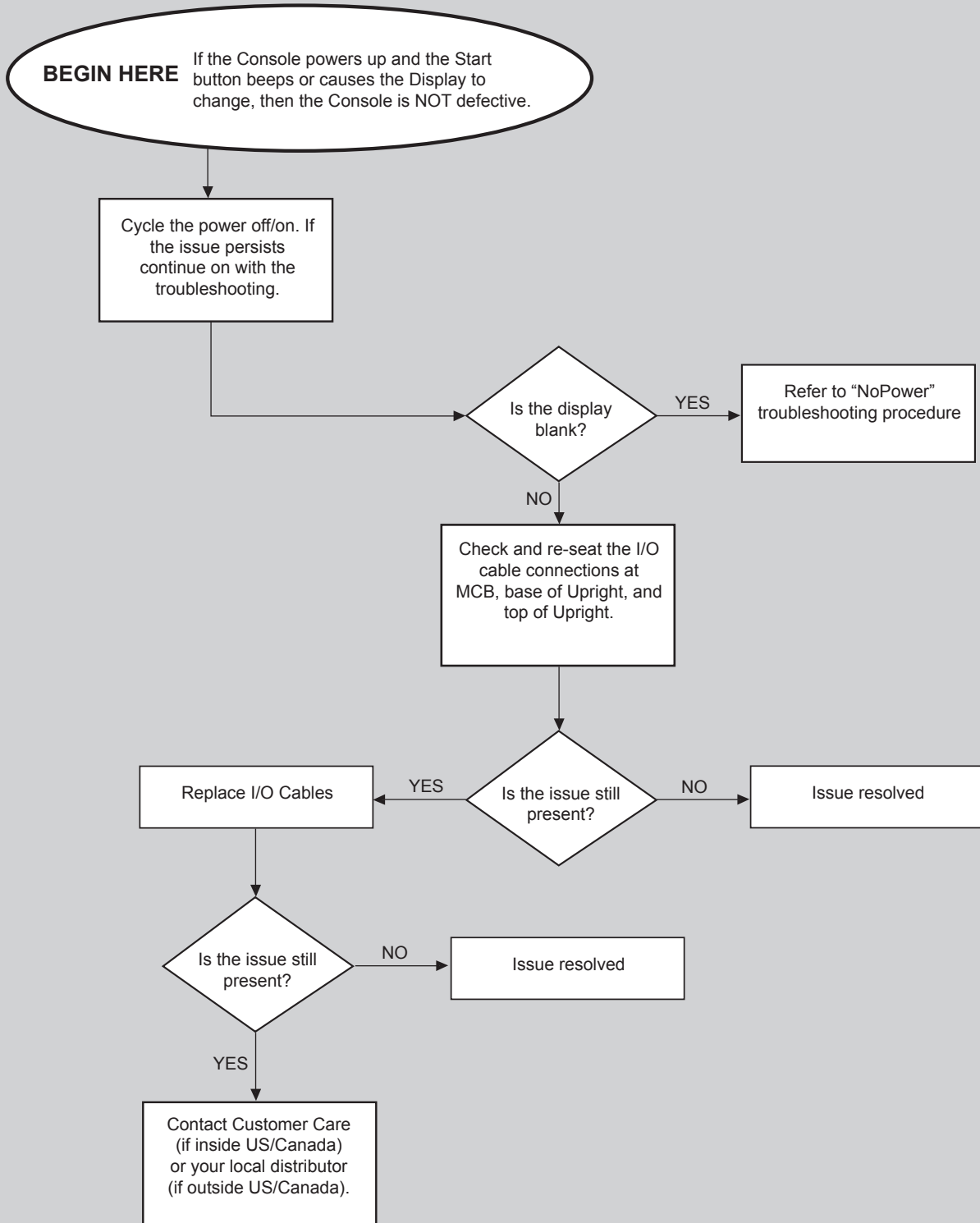

**Walking Belt stops while in use, moves briefly, or does not move at all (Console lights up)**

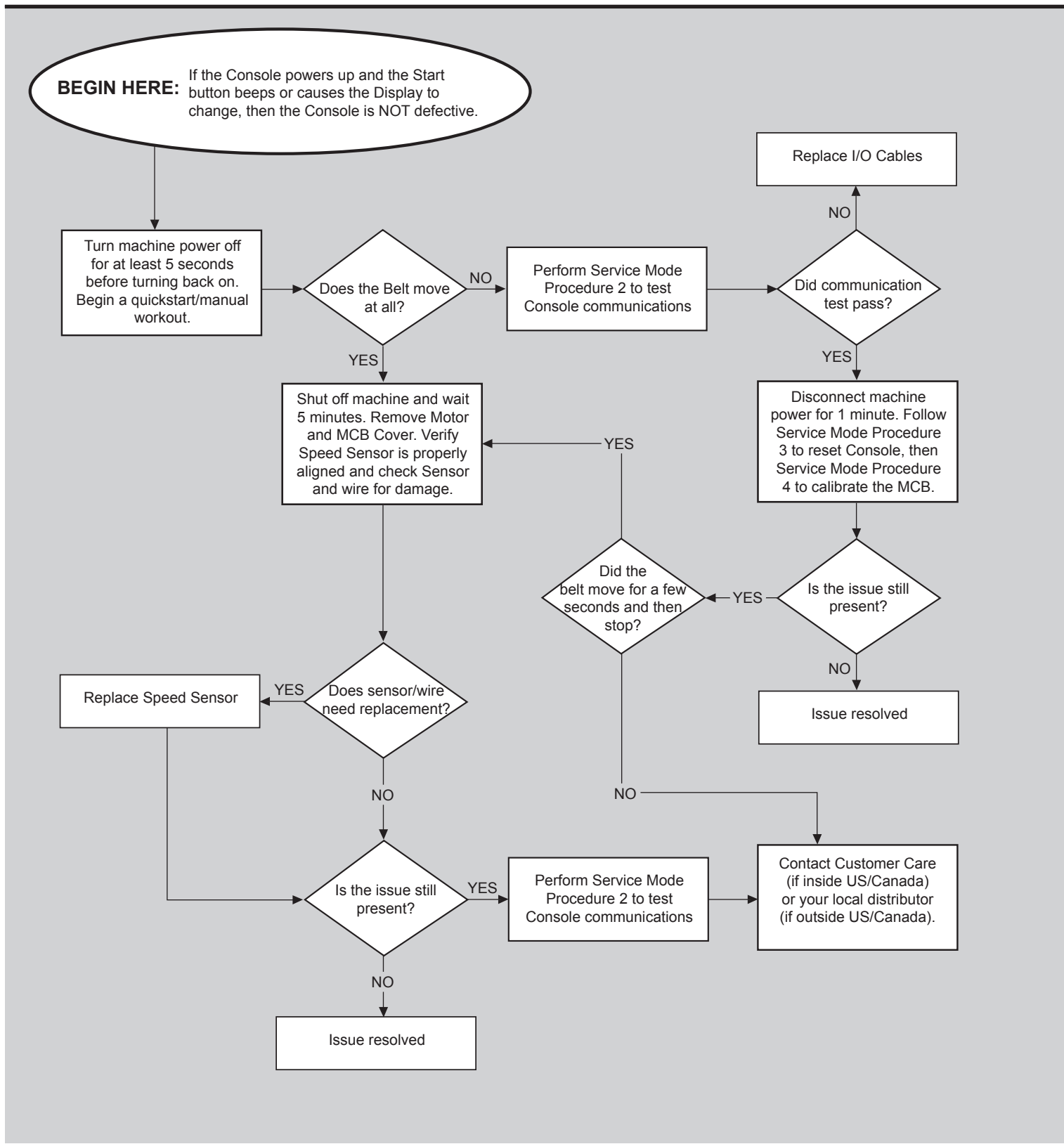

# Belt Alignment / Slipping / Hesitation

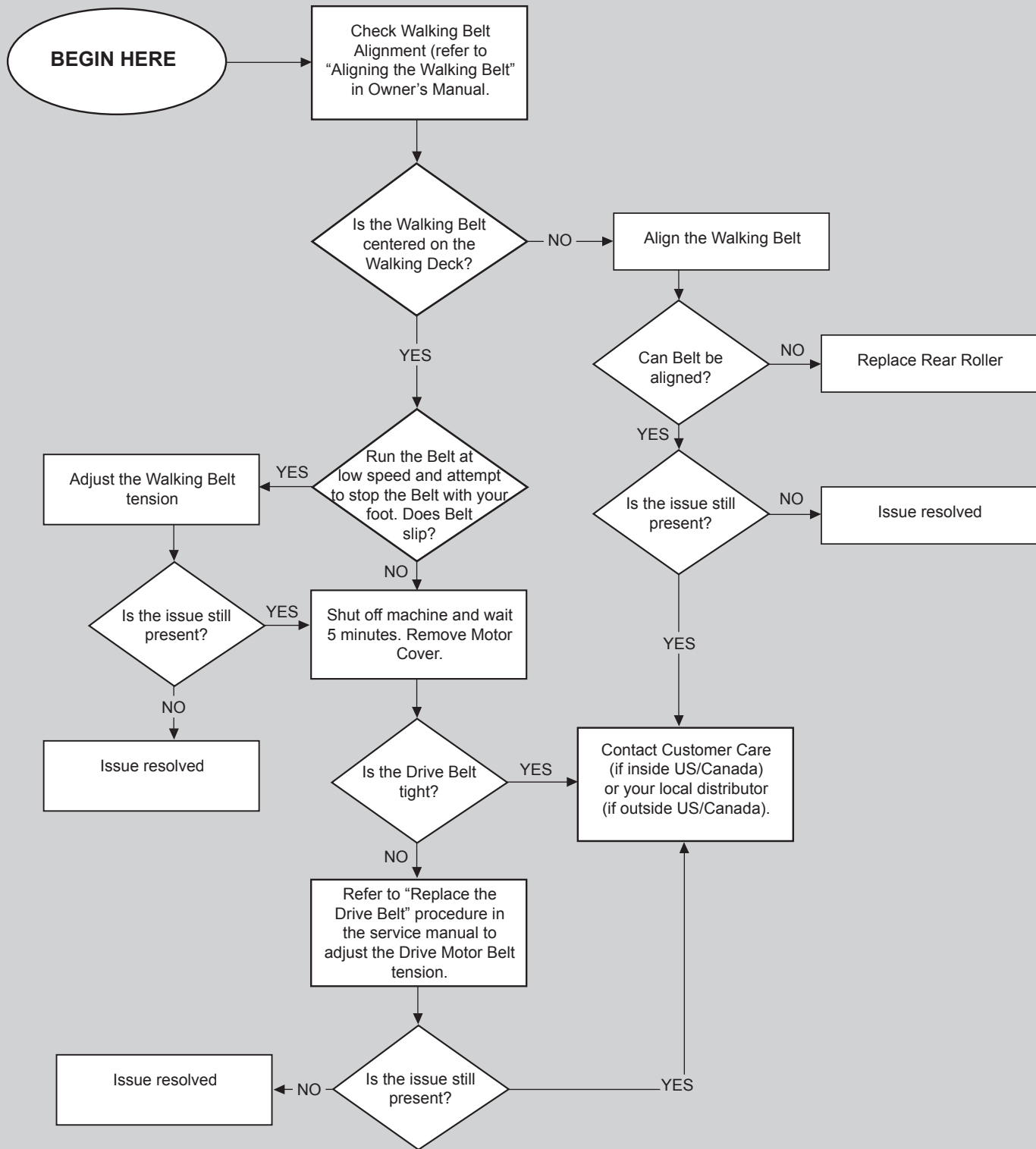

## ***MACHINE SETTINGS MODE***

The Machine Settings Mode lets you view the total run hours for the machine and the current versions of the main systems.

1. Hold down the PAUSE/STOP button and Down(▼) button together for 3 seconds while in the Power-Up Mode to access the Machine Settings Mode.

**Note:** Push PAUSE/STOP to exit the Machine Settings Mode and return to the Power-Up Mode screen.

2. The Console displays the TOTAL HOURS for the machine.
3. Push the Right(▶) button to go to the next option.
4. The Console display shows the current Console Firmware Version.
5. Push the Right(▶) button to go to the next option.
6. The Console display shows the current Motor Control Board Firmware Version.
7. Push the Right(▶) button to go to the next option.
8. The Console display shows the current BLE Version.
9. Push the Right(▶) button to go to the next option.
10. The Console displays the DISCONNECT BLE NO prompt.

**Note:** If you want to disconnect the Bluetooth® transmitter, push the Increase/Decrease buttons to select the “DISCONNECT BLE YES” option, and push Enter. The Console will exit the Machine Settings Mode and return to the Power-Up Mode screen.

11. Push the Right(▶) button to go to the next option.
12. The Console displays the VIEW ERROR MSG NO option. This option is for Service Technicians use only.
13. Push the Right(▶) button to go to the next option.
14. The Console displays the RESET CONSOLE NO prompt.

**Note:** If you want to reset the Console to factory settings, push the Increase/Decrease buttons to select the “RESET CONSOLE YES” option, and push Enter. Turn the machine off when the Console displays the “POWER CYCLE NOW” prompt.

15. Push the Right(▶) button to exit the Machine Settings Mode and return to the Power-Up Mode screen.

# **ENGINEERING MODE**

ENGINEERING MODE is a sub-menu from the MACHINE SETTINGS MODE. Most of the options contained within the Engineering Mode are for Service Technicians and should not need to be accessed by a user.

To access the Engineering Mode:

1. From the Power Up (or Welcome) screen, push and hold down the PAUSE/STOP button and Down(▼) arrow button for about 5 seconds to go into the Console Setup Mode. The Console display will show the TOTAL HOURS with the current value.

**Note:** Push PAUSE/STOP twice to exit the Console Setup Mode and return to the Power-Up Mode screen.

2. From the TOTAL HOURS screen, push and hold down the PAUSE/STOP button and Down(▼) arrow button for about 5 seconds to go into the Engineering Mode. The Console display will show the current Firmware Version.

Prompts displayed by the Console (in order using the Down arrow button) :

- A. ENTR MFG TEST
- B. Firmware Version ( "xxxxxxxxRxx" )
- C. ENTR NVM (Non-volatile memory) TST
- D. ENTR LCD
- E. ENTR LED TST 1
- F. ENTR RTC (Real time clock) TST
- G. ENTR AUD (Audio) TST
- H. ENTR HR TST
- I. ENTR KEY TST
- J. ENTR FAN TST
- K. ENTR BLE (Bluetooth Low Energy) TST
- L. ENTR ESTOP (Emergency Stop) TST
- M. ENTR MCB TST
- N. ENTR MCB CLB (Calibration)
- O. ENTR RST CNSL (Reset Console)

Push the PAUSE/STOP button twice to exit Engineering Mode.

# ELECTRICAL WIRING DIAGRAM

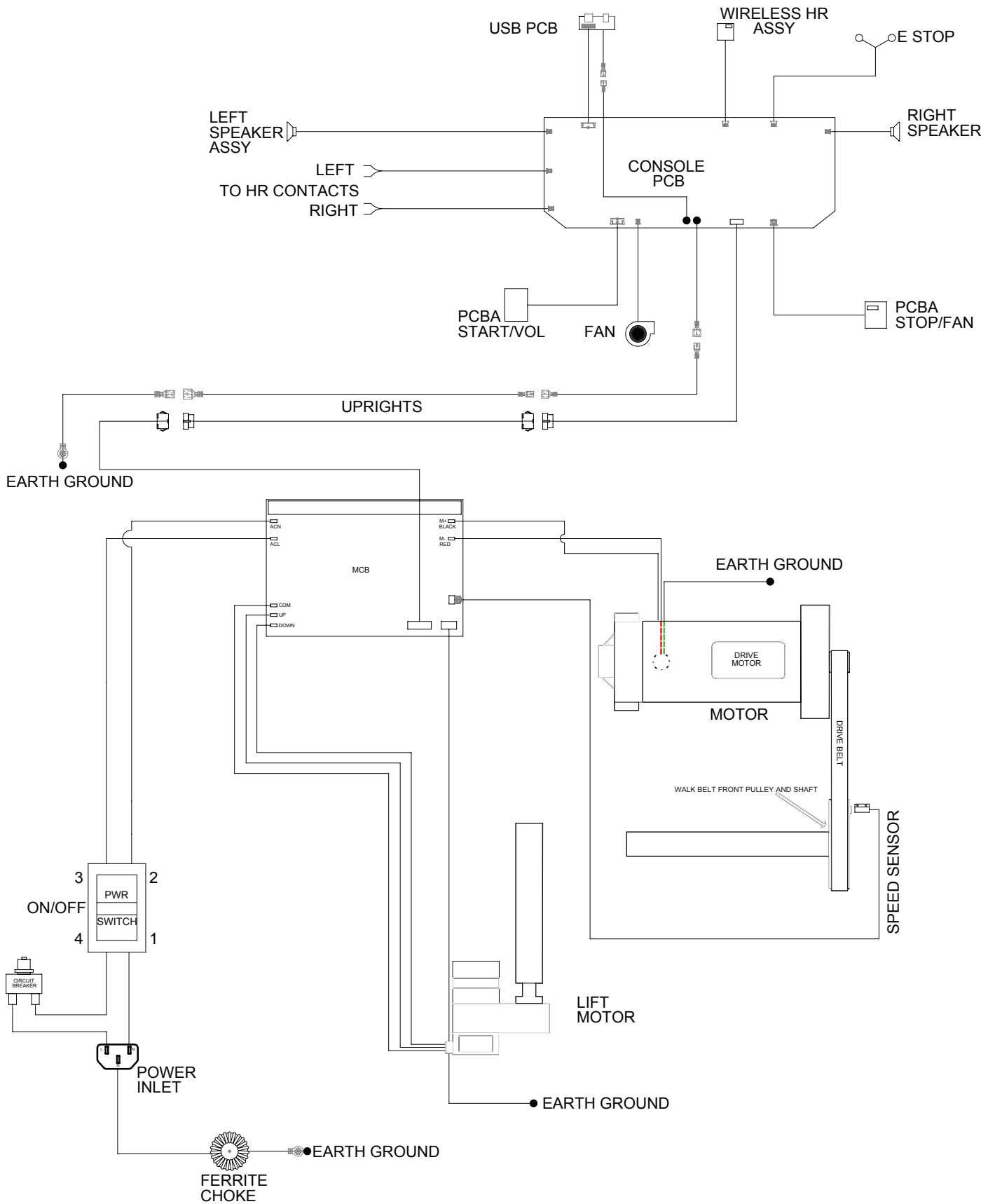



## **Replacement Procedure Skill Level**

- Level I : Low - very little mechanical knowledge or exposure.
- Level II : Intermediate - some experience with mechanical procedures.
- Level III : Advanced - knowledgeable about mechanical procedures.

**NOTICE:** This document provides instructions for the adjustment of the Walking Belt on the Bowflex™ BXT6 / BXT028 Treadmill.

If you need assistance, please contact Customer Service (if purchased in US/Canada) or your local distributor (if purchased outside US/Canada). To find your local distributor, go to: [www.nautilusinternational.com](http://www.nautilusinternational.com)

 **This icon means a potentially hazardous situation which, if not avoided, could result in death or serious injury. Read and understand all Warnings on this machine.**

Nautilus, Inc., [www.NautilusInc.com](http://www.NautilusInc.com), 5415 Centerpoint Parkway, Groveport, OH 43125 U.S.A. - Customer Service: North America (800) 605-3369, [csnls@nautilus.com](mailto:csnls@nautilus.com) | outside U.S. [www.nautilusinternational.com](http://www.nautilusinternational.com) | Printed in China | © 2018 Nautilus, Inc. | Bowflex and the B logo are trademarks owned or licensed by Nautilus, Inc., registered or otherwise protected by common law in the United States and other nations. | **ORIGINAL DOCUMENT - ENGLISH VERSION ONLY**

## Important Safety Instructions - Before servicing or using this equipment, obey the following warnings:

 **This icon means a potentially hazardous situation which, if not avoided, could result in death or serious injury. Read and understand all Warnings on this machine.**

**⚠ DANGER** To reduce the risk of electrical shock or unsupervised usage of the equipment, always unplug the power cord from the wall outlet and wait 5 minutes before cleaning, maintaining or repairing this machine. Place the power cord in a secure location.

- Read and understand the Part Replacement Procedure before working on the machine. Failure to obey the instructions and safety warnings could cause injury to the service technician or bystanders.
- Keep bystanders, children and pets away from the product being serviced at all times.
- Make sure that the repair is done in an appropriate work space away from foot traffic and exposure to bystanders.
- Disconnect all power and allow to sit for 5 minutes before you service this machine.
- Some components of the equipment can be heavy or awkward. Enlist the service of a second person when you do maintenance steps involving these components. Do not try to do heavy or awkward steps on your own.
- If replacement parts are necessary, use only genuine Nautilus replacement parts and hardware. Failure to use genuine replacement parts can cause a risk to users, keep the machine from operating correctly and will void the warranty.
- Be sure that all warning stickers and instructional placards applied to the product stay present and in good condition when doing maintenance or replacing components. If at any time the Warning labels become loose, unreadable or dislodged, replace the labels. If purchased in US/Canada, contact Customer Service for replacement labels. If purchased outside US/Canada, contact your local distributor for them.
- Do not try to change the design or functionality of the machine being serviced as this can adversely effect user safety and will void the warranty.
- Do not use the machine until all shrouds, instructions, warning labels and correct functionality have been verified and tested for correct performance.

### Tools Required (not included)

6mm hex wrench



1. Run the machine at 1 mph to see which way the Walking Belt needs to be moved.

 **Do not touch the Walking Belt. Be sure to keep bystanders, children and pets away from the machine.**

2. Using a 6mm hex wrench on the side the belt should move away from, rotate the Adjustment Bolt a 1/4 turn clock-wise.

3. Allow the Walking Belt to adjust to the new tension.

4. Repeat steps 2 and 3 until the Walking Belt is centered.

5. Final Inspection

Inspect your machine to ensure that all hardware is tight and components are properly assembled.

 **Do not use until the machine has been fully assembled and inspected for correct performance in accordance with the Owner's Manual.**

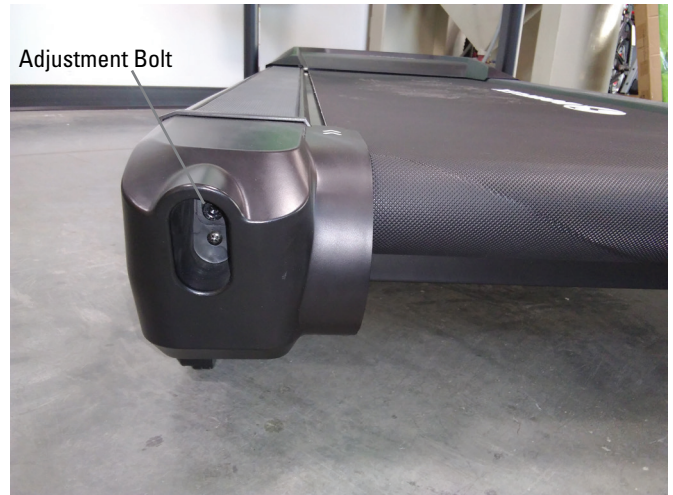
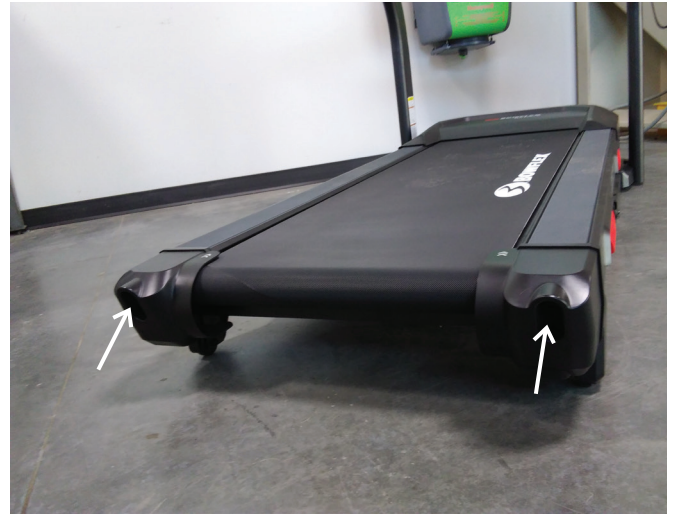

**NOTICE:** This document provides instructions for the replacement of the Circuit Breaker on the Bowflex™ BXT6 / BXT028 Treadmill.

If you need assistance, please contact Customer Service (if purchased in US/Canada) or your local distributor (if purchased outside US/Canada). To find your local distributor, go to: [www.nautilusinternational.com](http://www.nautilusinternational.com)

 **This icon means a potentially hazardous situation which, if not avoided, could result in death or serious injury. Read and understand all Warnings on this machine.**

Nautilus, Inc., [www.NautilusInc.com](http://www.NautilusInc.com), 5415 Centerpoint Parkway, Groveport, OH 43125 U.S.A. - Customer Service: North America (800) 605-3369, [csnls@nautilus.com](mailto:csnls@nautilus.com) | outside U.S. [www.nautilusinternational.com](http://www.nautilusinternational.com) | Printed in China | © 2020 Nautilus, Inc. | Bowflex and the B logo are trademarks owned or licensed by Nautilus, Inc., registered or otherwise protected by common law in the United States and other nations. | **ORIGINAL DOCUMENT - ENGLISH VERSION ONLY**

### Important Safety Instructions - Before servicing or using this equipment, obey the following warnings:

 **This icon means a potentially hazardous situation which, if not avoided, could result in death or serious injury. Read and understand all Warnings on this machine.**

**⚠ DANGER** To reduce the risk of electrical shock or unsupervised usage of the equipment, always unplug the power cord from the wall outlet and wait 5 minutes before cleaning, maintaining or repairing this machine. Place the power cord in a secure location.

- Read and understand the Part Replacement Procedure before working on the machine. Failure to obey the instructions and safety warnings could cause injury to the service technician or bystanders.
- Keep bystanders, children and pets away from the product being serviced at all times.
- Make sure that the repair is done in an appropriate work space away from foot traffic and exposure to bystanders.
- Disconnect all power and allow to sit for 5 minutes before you service this machine.
- Some components of the equipment can be heavy or awkward. Enlist the service of a second person when you do maintenance steps involving these components. Do not try to do heavy or awkward steps on your own.
- If replacement parts are necessary, use only genuine Nautilus replacement parts and hardware. Failure to use genuine replacement parts can cause a risk to users, keep the machine from operating correctly and will void the warranty.
- Be sure that all warning stickers and instructional placards applied to the product stay present and in good condition when doing maintenance or replacing components. If at any time the Warning labels become loose, unreadable or dislodged, replace the labels. If purchased in US/Canada, contact Customer Service for replacement labels. If purchased outside US/Canada, contact your local distributor for them.
- Do not try to change the design or functionality of the machine being serviced as this can adversely effect user safety and will void the warranty.
- Do not use the machine until all shrouds, instructions, warning labels and correct functionality have been verified and tested for correct performance.

### Tools Required (not included)

#2 Phillips screwdriver



**⚠ DANGER** To reduce the risk of electrical shock or unsupervised usage of the equipment, always unplug the power cord from the wall outlet and wait 5 minutes before cleaning, maintaining or repairing this machine. Place the power cord in a secure location.

1. Unplug the power cord from the machine and wait 5 minutes. Place the power cord in a secure location.

2. Using a #2 Phillips screwdriver remove the 4 indicated screws, and two additional screws on the far side, from the Motor Cover and remove it.



3. Using a #2 Phillips screwdriver remove the 2 indicated screws from the MCB Cover and remove it.

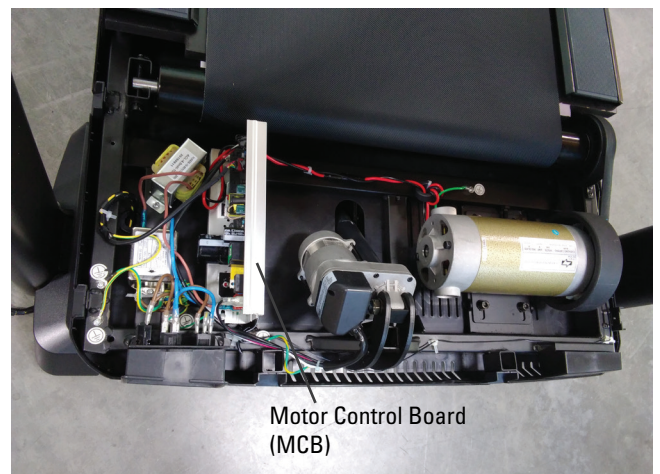
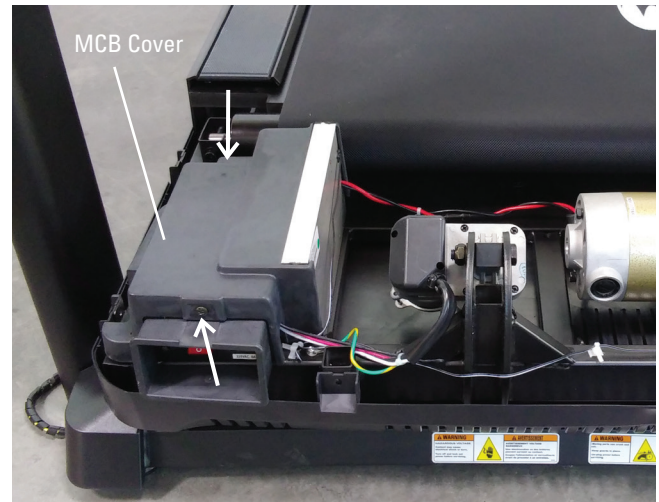



4. From the front, remove the Securing Ring from the Circuit Breaker by rotating it counter-clockwise. Remove the Circuit Breaker from the Frame.

5. Remove the connectors and attach them to the new Circuit Breaker.

6. Insert the new Circuit Breaker into the Frame and install the Securing Ring.

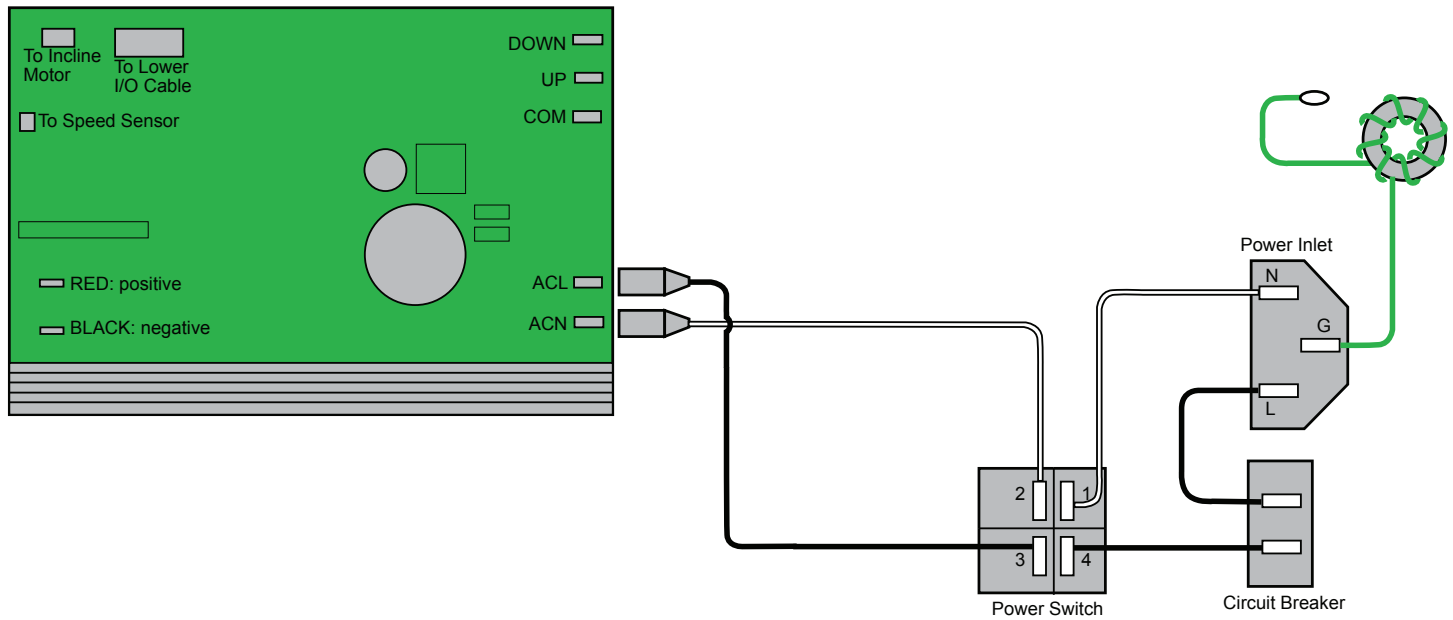

7. Re-install all remaining parts that were removed in reverse order.

8. Final Inspection

Inspect your machine to ensure that all hardware is tight and components are properly assembled.



**Do not use until the machine has been fully assembled and inspected for correct performance in accordance with the Owner's Manual.**

**NOTICE:** This document provides instructions for the replacement of the Console Assembly on the Bowflex™ BXT6 / BXT028 Treadmill.

If you need assistance, please contact Customer Service (if purchased in US/Canada) or your local distributor (if purchased outside US/Canada). To find your local distributor, go to: [www.nautilusinternational.com](http://www.nautilusinternational.com)

 This icon means a potentially hazardous situation which, if not avoided, could result in death or serious injury. Read and understand all Warnings on this machine.

Nautilus, Inc., [www.NautilusInc.com](http://www.NautilusInc.com), 5415 Centerpoint Parkway, Groveport, OH 43125 U.S.A. - Customer Service: North America (800) 605-3369, [csnls@nautilus.com](mailto:csnls@nautilus.com) | outside U.S. [www.nautilusinternational.com](http://www.nautilusinternational.com) | Printed in China | © 2020 Nautilus, Inc. | Bowflex and the B logo are trademarks owned or licensed by Nautilus, Inc., registered or otherwise protected by common law in the United States and other nations. | **ORIGINAL DOCUMENT - ENGLISH VERSION ONLY**

### Important Safety Instructions - Before servicing or using this equipment, obey the following warnings:

 This icon means a potentially hazardous situation which, if not avoided, could result in death or serious injury. Read and understand all Warnings on this machine.

**⚠ DANGER** To reduce the risk of electrical shock or unsupervised usage of the equipment, always unplug the power cord from the wall outlet and wait 5 minutes before cleaning, maintaining or repairing this machine. Place the power cord in a secure location.

- Read and understand the Part Replacement Procedure before working on the machine. Failure to obey the instructions and safety warnings could cause injury to the service technician or bystanders.
- Keep bystanders, children and pets away from the product being serviced at all times.
- Make sure that the repair is done in an appropriate work space away from foot traffic and exposure to bystanders.
- Disconnect all power and allow to sit for 5 minutes before you service this machine.
- Some components of the equipment can be heavy or awkward. Enlist the service of a second person when you do maintenance steps involving these components. Do not try to do heavy or awkward steps on your own.
- If replacement parts are necessary, use only genuine Nautilus replacement parts and hardware. Failure to use genuine replacement parts can cause a risk to users, keep the machine from operating correctly and will void the warranty.
- Be sure that all warning stickers and instructional placards applied to the product stay present and in good condition when doing maintenance or replacing components. If at any time the Warning labels become loose, unreadable or dislodged, replace the labels. If purchased in US/Canada, contact Customer Service for replacement labels. If purchased outside US/Canada, contact your local distributor for them.
- Do not try to change the design or functionality of the machine being serviced as this can adversely effect user safety and will void the warranty.
- Do not use the machine until all shrouds, instructions, warning labels and correct functionality have been verified and tested for correct performance.

### Tools Required (not included)

#2 Phillips screwdriver

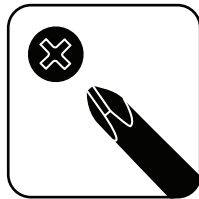

6mm hex wrench





**⚠ DANGER**

To reduce the risk of electrical shock or unsupervised usage of the equipment, always unplug the power cord from the wall outlet and wait 5 minutes before cleaning, maintaining or repairing this machine. Place the power cord in a secure location.

1. Unplug the power cord from the machine and wait 5 minutes. Place the power cord in a secure location.

2. . Using a #2 Phillips screwdriver, remove the 4 indicated screws (by arrows) from Lower Junction Covers.

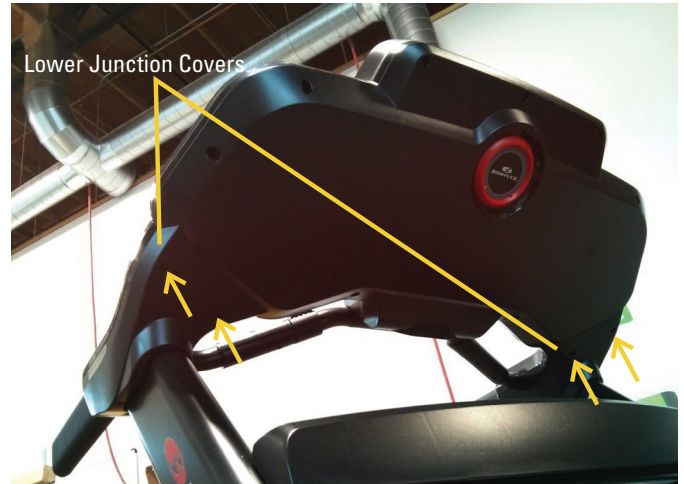

3. The Upper Junction Covers are released in two steps~ the inner snaps followed by the outer snap. From the outside of the machine, gently pinch both of the inside snaps (indicated with ovals) and roll the Upper Junction Cover up and outward from the machine.

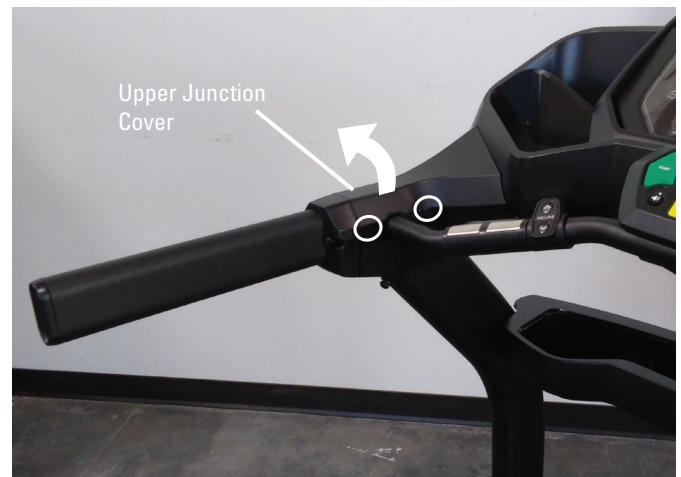

4. With the inner snaps of the Upper junction Covers released, gently pinch the outer snap (indicated by oval) to release the Upper Junction Cover.

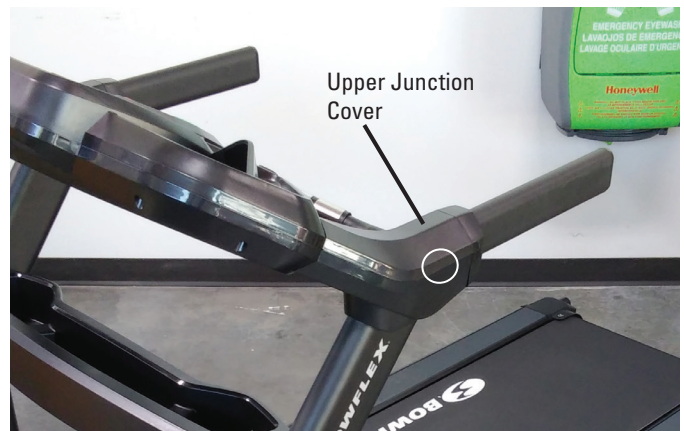

5. Gently pull out the Input/Output (I/O) and Grounding Cables from the Right Upright (indicated by arrow), and disconnect them. Do not allow the Cables to fall into the Right Upright. Secure them with a Zip-Tie, rubber band or piece of wire.

**Note:** Do not crimp the Cables.

6. Using a 6mm hex wrench, remove the 8 screws (indicated by ovals) that secure the Console Assembly from the Right and Left Uprights.

**Note:** To assist with re-assembly, be sure to note that the curved washers are used facing the rear of the machine.

7. Fully remove the Console and Handlebar Assembly from the Uprights.

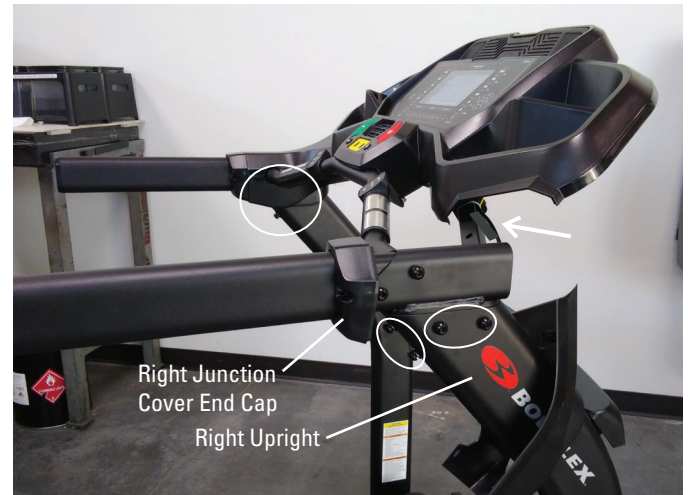

8. Using a 6mm hex wrench, remove the hardware from the Side Handlebars.

**Note:** To assist with re-assembly, be sure to note that the curved washers are used facing downward.

9. Remove the Side Handlebars with the Junction Cover End Caps (not in photo) from the old Console Assembly, and attach to the new Console Assembly.

10. With the new Console and Handlebar Assembly, connect the cables and attach it to the Uprights.

**Note:** This step may take two people to safely hold the Console and Handlebar Assembly and connect the Cables. Do not crimp the Cables.



11. Re-install all remaining parts that were removed in reverse order.

## 12. Final Inspection

Inspect your machine to ensure that all hardware is tight and components are properly assembled.



**Do not use until the machine has been fully assembled and inspected for correct performance in accordance with the Owner's Manual.**

**NOTICE:** This document provides instructions for the replacement of the Deck Suspension on the Bowflex™ BXT6 / BXT028 Treadmill.

If you need assistance, please contact Customer Service (if purchased in US/Canada) or your local distributor (if purchased outside US/Canada). To find your local distributor, go to: [www.nautilusinternational.com](http://www.nautilusinternational.com)

 **This icon means a potentially hazardous situation which, if not avoided, could result in death or serious injury. Read and understand all Warnings on this machine.**

Nautilus, Inc., [www.NautilusInc.com](http://www.NautilusInc.com), 5415 Centerpoint Parkway, Groveport, OH 43125 U.S.A. - Customer Service: North America (800) 605-3369, [csnls@nautilus.com](mailto:csnls@nautilus.com) | outside U.S. [www.nautilusinternational.com](http://www.nautilusinternational.com) | Printed in China | © 2020 Nautilus, Inc. | Bowflex and the B logo are trademarks owned or licensed by Nautilus, Inc., registered or otherwise protected by common law in the United States and other nations. | **ORIGINAL DOCUMENT - ENGLISH VERSION ONLY**

### Important Safety Instructions - Before servicing or using this equipment, obey the following warnings:

 **This icon means a potentially hazardous situation which, if not avoided, could result in death or serious injury. Read and understand all Warnings on this machine.**

**⚠ DANGER** To reduce the risk of electrical shock or unsupervised usage of the equipment, always unplug the power cord from the wall outlet and wait 5 minutes before cleaning, maintaining or repairing this machine. Place the power cord in a secure location.

- Read and understand the Part Replacement Procedure before working on the machine. Failure to obey the instructions and safety warnings could cause injury to the service technician or bystanders.
- Keep bystanders, children and pets away from the product being serviced at all times.
- Make sure that the repair is done in an appropriate work space away from foot traffic and exposure to bystanders.
- Disconnect all power and allow to sit for 5 minutes before you service this machine.
- Some components of the equipment can be heavy or awkward. Enlist the service of a second person when you do maintenance steps involving these components. Do not try to do heavy or awkward steps on your own.
- If replacement parts are necessary, use only genuine Nautilus replacement parts and hardware. Failure to use genuine replacement parts can cause a risk to users, keep the machine from operating correctly and will void the warranty.
- Be sure that all warning stickers and instructional placards applied to the product stay present and in good condition when doing maintenance or replacing components. If at any time the Warning labels become loose, unreadable or dislodged, replace the labels. If purchased in US/Canada, contact Customer Service for replacement labels. If purchased outside US/Canada, contact your local distributor for them.
- Do not try to change the design or functionality of the machine being serviced as this can adversely effect user safety and will void the warranty.
- Do not use the machine until all shrouds, instructions, warning labels and correct functionality have been verified and tested for correct performance.

### Tools Required (not included)

#2 Phillips screwdriver

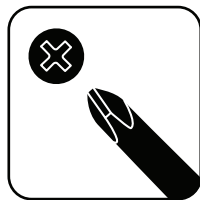

**⚠ DANGER** To reduce the risk of electrical shock or unsupervised usage of the equipment, always unplug the power cord from the wall outlet and wait 5 minutes before cleaning, maintaining or repairing this machine. Place the power cord in a secure location.

1. Unplug the power cord from the machine and wait 5 minutes. Place the power cord in a secure location.

2. Make sure that there is safe clearance around, on and above the treadmill. Make sure there is no object to spill or cause blockage from the fully folded position.

**⚠** Be sure there is adequate height clearance for the raised deck.



3. Using the support bar found below the rear of the walking belt, lift the walking deck fully upward and engage the hydraulic lift. Be sure that the hydraulic lift is correctly locked in place. You will hear an audible click when the hydraulic lift shifts into the locked position.

**⚠** Use proper safety precautions and lifting techniques. Bend your knees and elbows, keep your back straight and pull up equally with both arms. Make sure that your own physical strength is capable of lifting the walking deck until it engages the locking mechanism. Use a second person if necessary.

**Do not use the walking belt or rear roller to lift the treadmill. These parts do not lock in place and can abruptly move. Injury to you or damage to the machine can occur.**

4. Make sure that the locking mechanism is engaged. Carefully pull back on the walking deck and make sure that it does not move. When you do this, keep clear of movement path in case the treadmill lock is not properly engaged.

**⚠** Do not lean against the treadmill when it is folded. Do not put items on it that could cause it to become unstable or fall.





5. Using a #2 Phillips screwdriver remove the 4 indicated screws from the Deck Suspensions on each side of the machine.

6. Remove the old Deck Suspensions, and replace with the new Deck Suspensions.



7. Make sure there is sufficient space to lower the walking deck.

**⚠ Keep a minimum clearance behind the machine of 79" (2 m) and 24" (0.6 m) on each side. This is the recommended safe distance for access, movement and emergency dismounts from the machine.**

8. Make sure there is no object on or around the treadmill to spill or cause blockage from the fully unfolded position.

9. Slightly push the walking deck forward toward the console. With your foot lightly push the top part of the hydraulic lift forward until the locking tube releases and you can pull the walking deck away from the console. Hold up the rear of the walking deck, and move to the side of the machine.

**⚠ Keep clear of the movement path of the walking deck.**



10. The hydraulic lift is set up to drop gradually. Hold onto the walking deck until approximately 2/3 of the movement down. Lower the weight with your legs. Be aware that the walking deck can possibly drop quickly in the last part of the movement.

11. Final Inspection

Inspect your machine to ensure that all hardware is tight and components are properly assembled.

**⚠ Do not use until the machine has been fully assembled and inspected for correct performance in accordance with the Owner's Manual.**

**NOTICE:** This document provides instructions for the replacement of the Deck Wheel on the Bowflex™ BXT6 / BXT028 Treadmill.

If you need assistance, please contact Customer Service (if purchased in US/Canada) or your local distributor (if purchased outside US/Canada). To find your local distributor, go to: [www.nautilusinternational.com](http://www.nautilusinternational.com)

**This icon means a potentially hazardous situation which, if not avoided, could result in death or serious injury. Read and understand all Warnings on this machine.**

Nautilus, Inc., [www.NautilusInc.com](http://www.NautilusInc.com), 5415 Centerpoint Parkway, Groveport, OH 43125 U.S.A. - Customer Service: North America (800) 605-3369, [csnls@nautilus.com](mailto:csnls@nautilus.com) | outside U.S. [www.nautilusinternational.com](http://www.nautilusinternational.com) | Printed in China | © 2020 Nautilus, Inc. | Bowflex and the B logo are trademarks owned or licensed by Nautilus, Inc., registered or otherwise protected by common law in the United States and other nations. | **ORIGINAL DOCUMENT - ENGLISH VERSION ONLY**

### Important Safety Instructions - Before servicing or using this equipment, obey the following warnings:

**This icon means a potentially hazardous situation which, if not avoided, could result in death or serious injury. Read and understand all Warnings on this machine.**

**⚠ DANGER** To reduce the risk of electrical shock or unsupervised usage of the equipment, always unplug the power cord from the wall outlet and wait 5 minutes before cleaning, maintaining or repairing this machine. Place the power cord in a secure location.

- Read and understand the Part Replacement Procedure before working on the machine. Failure to obey the instructions and safety warnings could cause injury to the service technician or bystanders.
- Keep bystanders, children and pets away from the product being serviced at all times.
- Make sure that the repair is done in an appropriate work space away from foot traffic and exposure to bystanders.
- Disconnect all power and allow to sit for 5 minutes before you service this machine.
- Some components of the equipment can be heavy or awkward. Enlist the service of a second person when you do maintenance steps involving these components. Do not try to do heavy or awkward steps on your own.
- If replacement parts are necessary, use only genuine Nautilus replacement parts and hardware. Failure to use genuine replacement parts can cause a risk to users, keep the machine from operating correctly and will void the warranty.
- Be sure that all warning stickers and instructional placards applied to the product stay present and in good condition when doing maintenance or replacing components. If at any time the Warning labels become loose, unreadable or dislodged, replace the labels. If purchased in US/Canada, contact Customer Service for replacement labels. If purchased outside US/Canada, contact your local distributor for them.
- Do not try to change the design or functionality of the machine being serviced as this can adversely effect user safety and will void the warranty.
- Do not use the machine until all shrouds, instructions, warning labels and correct functionality have been verified and tested for correct performance.

### Tools Required (not included)

#2 Phillips screwdriver

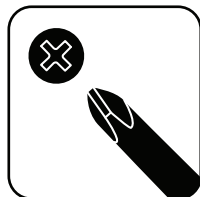

6mm Hex Wrench



13mm Wrench



**⚠ DANGER** To reduce the risk of electrical shock or unsupervised usage of the equipment, always unplug the power cord from the wall outlet and wait 5 minutes before cleaning, maintaining or repairing this machine. Place the power cord in a secure location.

1. Unplug the power cord from the machine and wait 5 minutes. Place the power cord in a secure location.

2. Using the support bar found below the rear of the walking belt, lift the walking deck fully upward and engage the hydraulic lift. Be sure that the hydraulic lift is correctly locked in place. You will hear an audible click when the hydraulic lift shifts into the locked position.

**⚠** Use proper safety precautions and lifting techniques. Bend your knees and elbows, keep your back straight and pull up equally with both arms. Make sure that your own physical strength is capable of lifting the walking deck until it engages the locking mechanism. Use a second person if necessary.

**Do not use the walking belt or rear roller to lift the treadmill. These parts do not lock in place and can abruptly move. Injury to you or damage to the machine can occur.**

3. Make sure that the locking mechanism is engaged. Carefully pull back on the walking deck and make sure that it does not move. When you do this, keep clear of movement path in case the treadmill lock is not properly engaged.

**⚠** Do not lean against the treadmill when it is folded. Do not put items on it that could cause it to become unstable or fall.



4. Using a #2 Phillips screwdriver, remove the 2 screws (indicated with arrows) from the Deck Wheel Cover.

5. Remove the Deck Wheel Cover from the machine.

6. Using a 13mm wrench and a 6mm hex wrench, remove the hardware (indicated by oval) from the Deck Wheel.

7. Remove the old Deck Wheel and replace with the new Deck Wheel.

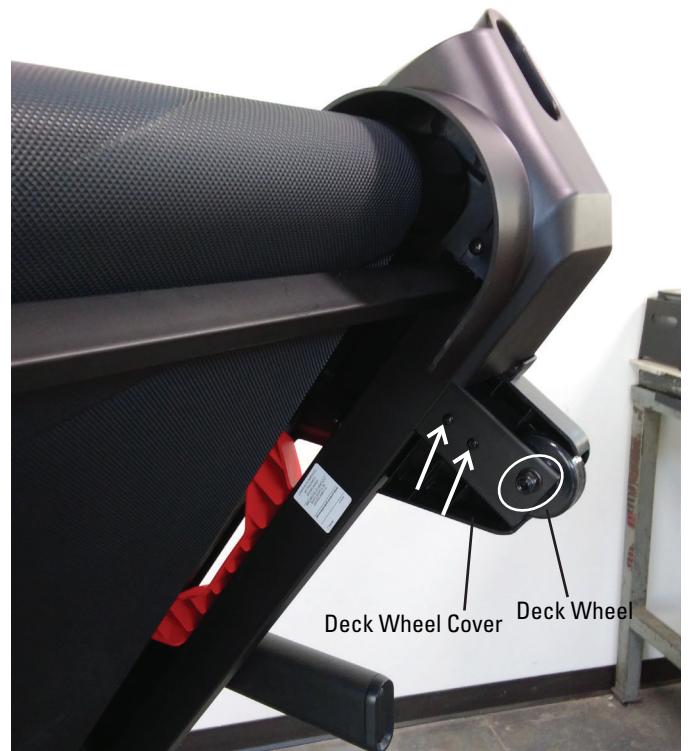

8. Re-install all remaining parts that were removed in reverse order.

9. Make sure there is sufficient space to lower the walking deck.

**⚠ Keep a minimum clearance behind the machine of 79" (2 m) and 24" (0.6 m) on each side. This is the recommended safe distance for access, movement and emergency dismounts from the machine.**

10. Make sure there is no object on or around the treadmill to spill or cause blockage from the fully unfolded position.

11. Slightly push the walking deck forward toward the console. With your foot lightly push the top part of the hydraulic lift forward until the locking tube releases and you can pull the walking deck away from the console. Hold up the rear of the walking deck, and move to the side of the machine.

**⚠ Keep clear of the movement path of the walking deck.**

12. The hydraulic lift is set up to drop gradually. Hold onto the walking deck until approximately 2/3 of the movement down. Lower the weight with your legs. Be aware that the walking deck can possibly drop quickly in the last part of the movement.



13. Final Inspection

Inspect your machine to ensure that all hardware is tight and components are properly assembled.

**⚠ Do not use until the machine has been fully assembled and inspected for correct performance in accordance with the Owner's Manual.**



**NOTICE:** This document provides instructions for the replacement of the Drive Belt on the Bowflex™ BXT6 / BXT028 Treadmill.

If you need assistance, please contact Customer Service (if purchased in US/Canada) or your local distributor (if purchased outside US/Canada). To find your local distributor, go to: [www.nautilusinternational.com](http://www.nautilusinternational.com)

**This icon means a potentially hazardous situation which, if not avoided, could result in death or serious injury. Read and understand all Warnings on this machine.**

Nautilus, Inc., [www.NautilusInc.com](http://www.NautilusInc.com), 5415 Centerpoint Parkway, Groveport, OH 43125 U.S.A. - Customer Service: North America (800) 605-3369, [csnls@nautilus.com](mailto:csnls@nautilus.com) | outside U.S. [www.nautilusinternational.com](http://www.nautilusinternational.com) | Printed in China | © 2020 Nautilus, Inc. | Bowflex and the B logo are trademarks owned or licensed by Nautilus, Inc., registered or otherwise protected by common law in the United States and other nations. | **ORIGINAL DOCUMENT - ENGLISH VERSION ONLY**

### Important Safety Instructions - Before servicing or using this equipment, obey the following warnings:

**This icon means a potentially hazardous situation which, if not avoided, could result in death or serious injury. Read and understand all Warnings on this machine.**

**⚠ DANGER** To reduce the risk of electrical shock or unsupervised usage of the equipment, always unplug the power cord from the wall outlet and wait 5 minutes before cleaning, maintaining or repairing this machine. Place the power cord in a secure location.

- Read and understand the Part Replacement Procedure before working on the machine. Failure to obey the instructions and safety warnings could cause injury to the service technician or bystanders.
- Keep bystanders, children and pets away from the product being serviced at all times.
- Make sure that the repair is done in an appropriate work space away from foot traffic and exposure to bystanders.
- Disconnect all power and allow to sit for 5 minutes before you service this machine.
- Some components of the equipment can be heavy or awkward. Enlist the service of a second person when you do maintenance steps involving these components. Do not try to do heavy or awkward steps on your own.
- If replacement parts are necessary, use only genuine Nautilus replacement parts and hardware. Failure to use genuine replacement parts can cause a risk to users, keep the machine from operating correctly and will void the warranty.
- Be sure that all warning stickers and instructional placards applied to the product stay present and in good condition when doing maintenance or replacing components. If at any time the Warning labels become loose, unreadable or dislodged, replace the labels. If purchased in US/Canada, contact Customer Service for replacement labels. If purchased outside US/Canada, contact your local distributor for them.
- Do not try to change the design or functionality of the machine being serviced as this can adversely effect user safety and will void the warranty.
- Do not use the machine until all shrouds, instructions, warning labels and correct functionality have been verified and tested for correct performance.

### Tools Required (not included)

#2 Phillips screwdriver



6mm Hex Wrench



13mm Wrench



**⚠ DANGER** To reduce the risk of electrical shock or unsupervised usage of the equipment, always unplug the power cord from the wall outlet and wait 5 minutes before cleaning, maintaining or repairing this machine. Place the power cord in a secure location.

1. Unplug the power cord from the machine and wait 5 minutes. Place the power cord in a secure location.



2. Using a #2 Phillips screwdriver remove the 4 indicated screws, and two additional screws on the far side, from the Motor Cover and remove it.

3. Using a #2 Phillips screwdriver remove the 2 indicated screws from the MCB Cover and remove it.

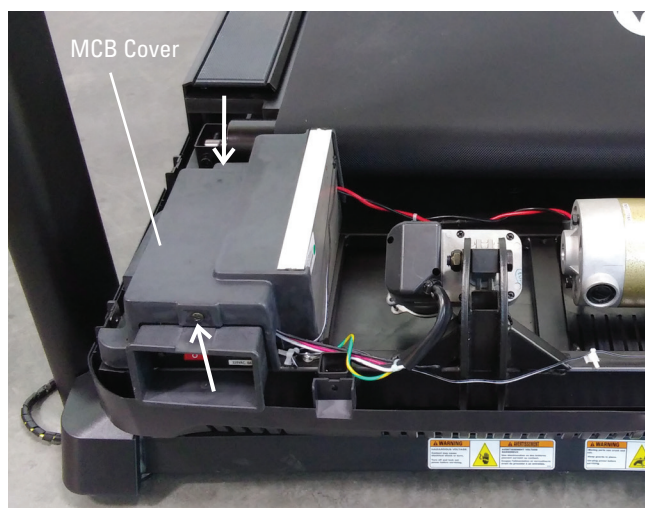

4. Using a 6mm hex wrench, remove the indicated screw from the Front Roller.

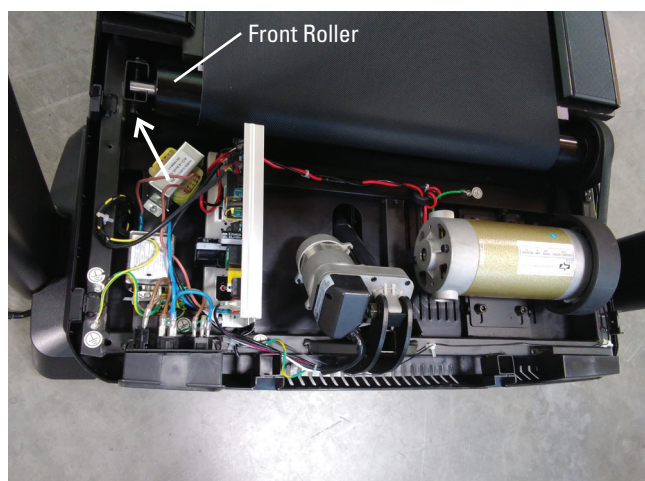

5. Be sure to observe the distance from the Speed Sensor to the Drive Pulley. This distance affects the effectiveness of the Speed Sensor, and can easily be shifted accidentally during replacement procedures.

6. Using a 6mm hex wrench, loosen the indicated screws (indicated by arrows) on the Motor Mount.

7. Using a 13mm Open Ended Wrench, rotate the Belt Tensioner Screw enough to remove the Drive Belt from the Motor.

**Note:** To assist with reassembly, be sure to record the number of threads exposed before loosening.

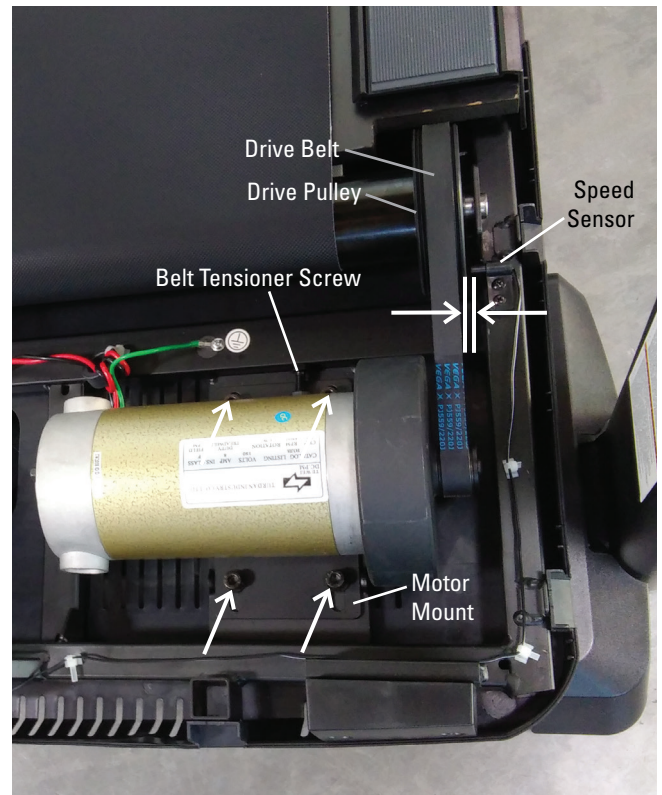

**Note:** Your machine may not match the provided images exactly.

8. Lift and pivot the Front Roller out of the Frame, and slide it out of the Drive Belt. This will free the Drive Belt from the Front Roller.

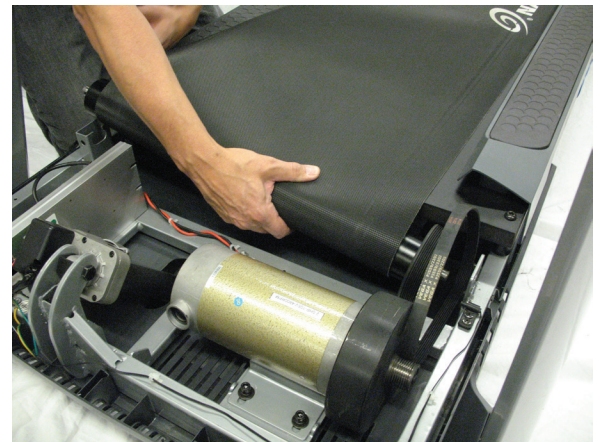

9. Loop the new Drive Belt around the Motor Pulley. Start the Drive Belt on the Drive Pulley and roll it in a clockwise motion. Be sure the Belt does not come off of the Motor Pulley.

**!** Keep fingers out of any pinch opportunities when turning the Pulleys.

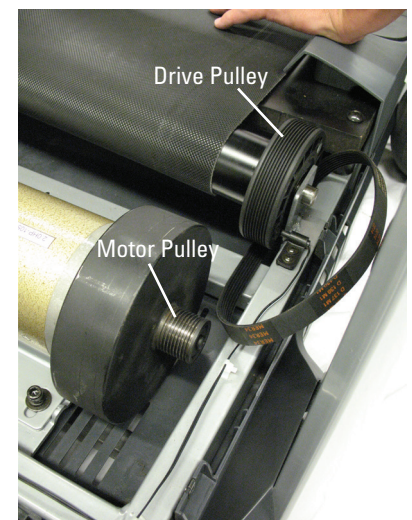



10. Using a 6mm hex wrench, attach the Front Roller to the Bracket.

**Note:** Tighten the hardware until the Front Roller is centered in the Bracket.

11. Roll the Drive Pulley clockwise until the Drive Belt is fully installed. Continue to roll the Belt forward while adding side pressure with fingers to align as necessary.

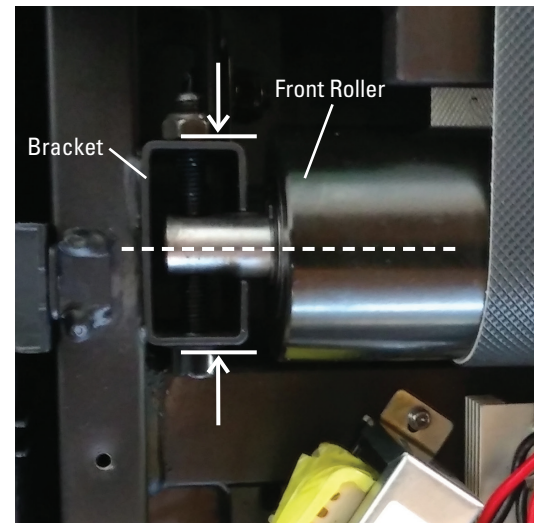

12. With the Motor Assembly loosely attached to the Frame, turn the Belt Tensioner Screw to the previous level. This will tighten the Drive Belt to the previous tension level.

13. Using a 6mm hex wrench, fully tighten the screws that attach the Motor Mount to the Frame.

14. Inspect the Speed Sensor to see if it has been moved during the procedure. If necessary, adjust it to be the appropriate distance from the Drive Pulley.

15. Re-install all remaining parts that were removed in reverse order.

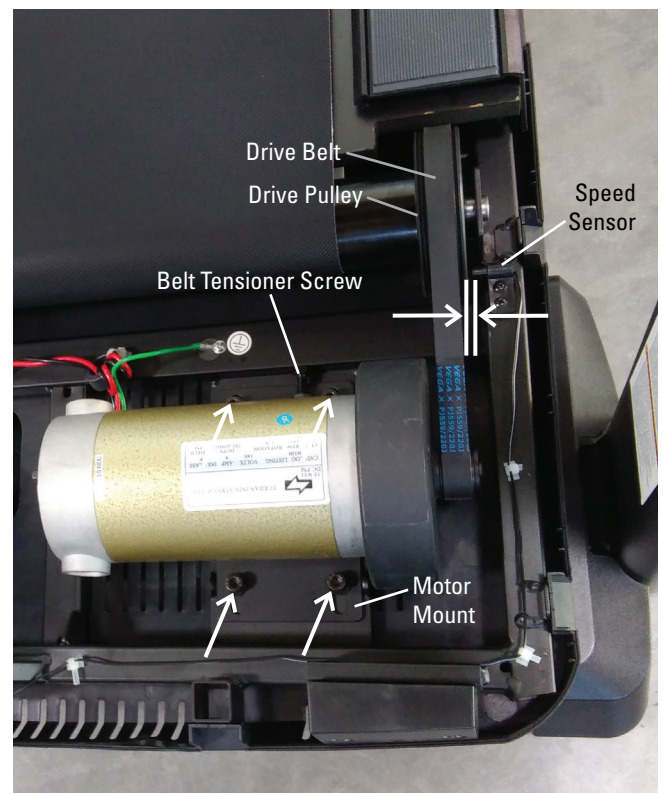

16. Attach the power cord and turn on the Treadmill by flipping the power switch to ON.

17. Attach the power cord and turn on the Treadmill by flipping the power switch to ON.

18. From the Power Up (or Welcome) screen, push and hold down the PAUSE/STOP button and Down arrow button for about 5 seconds to go into the Machine Setting Mode. The Console display will show the TOTAL HOURS screen.

19. Push and hold down the PAUSE/STOP button and Down arrow button for about 5 seconds to go into the Engineering Mode.

20. Push the Down arrow button 12 times until the Console displays “ENTR MCB CLB”.

 **Be sure the area around the Treadmill is clear of all bystanders, children and pets. Be sure there is nothing on or under the Walking Belt, or near the Treadmill.**

21. The Console will display “MCB CALIB”.

22. With the area clear, push the ENTER button. The calibration procedure will begin by automatically moving the Walking Belt.

 **Be sure not to touch or allow anyone else to touch the machine while calibration is occurring.**

23. When calibration is complete, the Console will display “DONE”.

24. Push the PAUSE/STOP button to exit the Engineering Mode.

25. Flip the power switch to OFF. Calibration is now complete for the machine.

26. Final Inspection

Inspect your machine to ensure that all hardware is tight and components are properly assembled.

 **Do not use until the machine has been fully assembled and inspected for correct performance in accordance with the Owner’s Manual.**

**NOTICE:** This document provides instructions for the replacement of the Front Roller on the Bowflex™ BXT6 / BXT028 Treadmill.

If you need assistance, please contact Customer Service (if purchased in US/Canada) or your local distributor (if purchased outside US/Canada). To find your local distributor, go to: [www.nautilusinternational.com](http://www.nautilusinternational.com)

**This icon means a potentially hazardous situation which, if not avoided, could result in death or serious injury. Read and understand all Warnings on this machine.**

Nautilus, Inc., [www.NautilusInc.com](http://www.NautilusInc.com), 5415 Centerpoint Parkway, Groveport, OH 43125 U.S.A. - Customer Service: North America (800) 605-3369, [csnls@nautilus.com](mailto:csnls@nautilus.com) | outside U.S. [www.nautilusinternational.com](http://www.nautilusinternational.com) | Printed in China | © 2020 Nautilus, Inc. | Bowflex and the B logo are trademarks owned or licensed by Nautilus, Inc., registered or otherwise protected by common law in the United States and other nations. | **ORIGINAL DOCUMENT - ENGLISH VERSION ONLY**

### Important Safety Instructions - Before servicing or using this equipment, obey the following warnings:

**This icon means a potentially hazardous situation which, if not avoided, could result in death or serious injury. Read and understand all Warnings on this machine.**

**⚠ DANGER** To reduce the risk of electrical shock or unsupervised usage of the equipment, always unplug the power cord from the wall outlet and wait 5 minutes before cleaning, maintaining or repairing this machine. Place the power cord in a secure location.

- Read and understand the Part Replacement Procedure before working on the machine. Failure to obey the instructions and safety warnings could cause injury to the service technician or bystanders.
- Keep bystanders, children and pets away from the product being serviced at all times.
- Make sure that the repair is done in an appropriate work space away from foot traffic and exposure to bystanders.
- Disconnect all power and allow to sit for 5 minutes before you service this machine.
- Some components of the equipment can be heavy or awkward. Enlist the service of a second person when you do maintenance steps involving these components. Do not try to do heavy or awkward steps on your own.
- If replacement parts are necessary, use only genuine Nautilus replacement parts and hardware. Failure to use genuine replacement parts can cause a risk to users, keep the machine from operating correctly and will void the warranty.
- Be sure that all warning stickers and instructional placards applied to the product stay present and in good condition when doing maintenance or replacing components. If at any time the Warning labels become loose, unreadable or dislodged, replace the labels. If purchased in US/Canada, contact Customer Service for replacement labels. If purchased outside US/Canada, contact your local distributor for them.
- Do not try to change the design or functionality of the machine being serviced as this can adversely effect user safety and will void the warranty.
- Do not use the machine until all shrouds, instructions, warning labels and correct functionality have been verified and tested for correct performance.

### Tools Required (not included)

#2 Phillips screwdriver

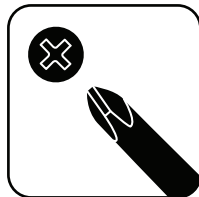

6mm Hex Wrench



13mm Wrench



**⚠ DANGER** To reduce the risk of electrical shock or unsupervised usage of the equipment, always unplug the power cord from the wall outlet and wait 5 minutes before cleaning, maintaining or repairing this machine. Place the power cord in a secure location.

1. Unplug the power cord from the machine and wait 5 minutes. Place the power cord in a secure location.



2. Using a #2 Phillips screwdriver remove the 4 indicated screws, and two additional screws on the far side, from the Motor Cover and remove it.

3. Using a #2 Phillips screwdriver remove the 2 indicated screws from the MCB Cover and remove it.

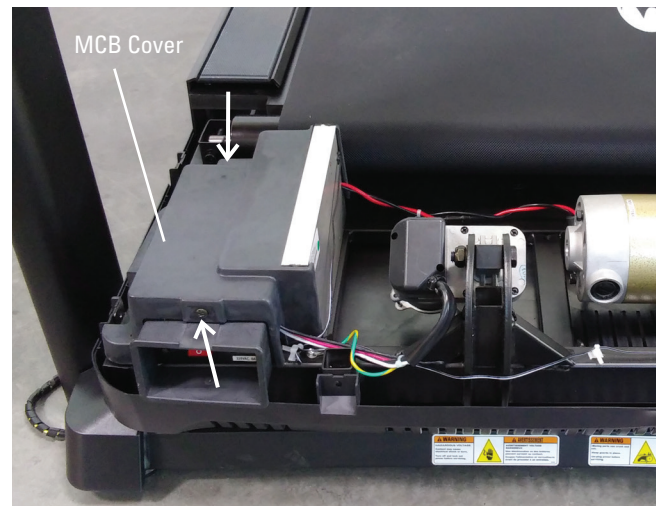

4. Using a 6mm hex wrench, remove the indicated screw from the old Front Roller.

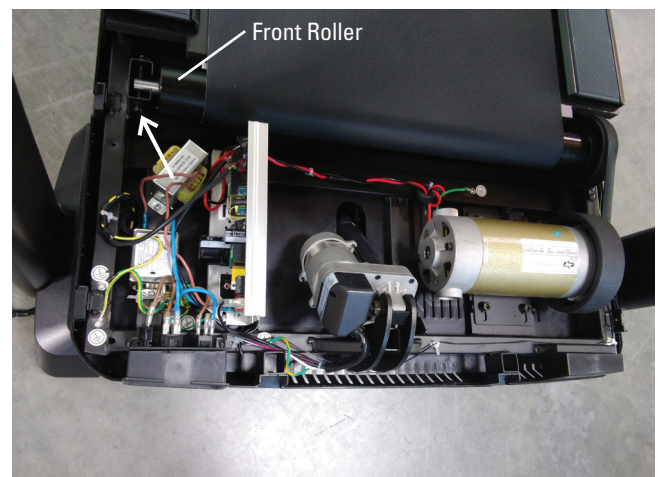



5. Be sure to observe the distance from the Speed Sensor to the Drive Pulley. This distance affects the effectiveness of the Speed Sensor, and can easily be shifted accidentally during replacement procedures.

6. Using a 6mm hex wrench, loosen the indicated screws (indicated by arrows) on the Motor Mount.

7. Using a 13mm Open Ended Wrench, rotate the Belt Tensioner Screw enough to remove the Drive Belt from the Motor.

**Note:** To assist with reassembly, be sure to record the number of threads exposed before loosening.

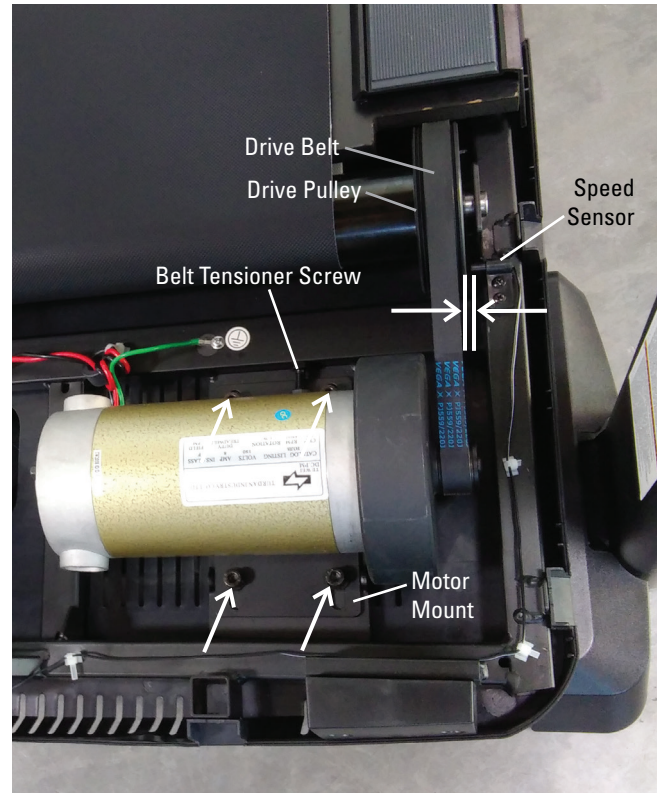

**Note:** Your machine may not match the provided images exactly.

8. Lift and pivot the old Front Roller out of the Frame, and slide it out of the Drive Belt. This will free the Drive Belt from the Front Roller.

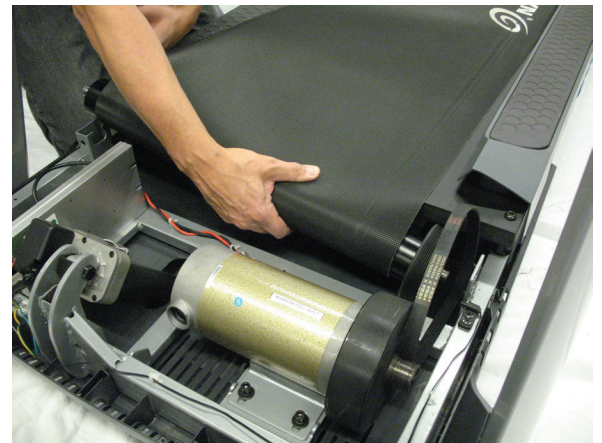

9. Slide the new Front Roller into the Walking Belt in the same orientation.

10. Loop the Drive Belt around the Front Roller. Insert the end of the Front Roller with the Drive Pulley into the Frame and pivot the other end into the Bracket.

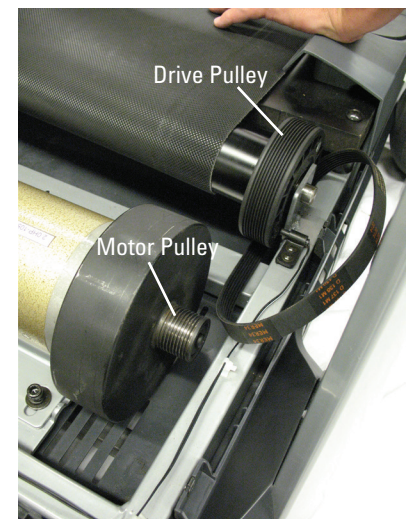



11. Using a 6mm hex wrench, attach the Front Roller to the Bracket.

**Note:** Tighten the hardware until the Front Roller is centered in the Bracket.

12. Roll the Drive Pulley clockwise until the Drive Belt is fully installed. Continue to roll the Belt forward while adding side pressure with fingers to align as necessary.

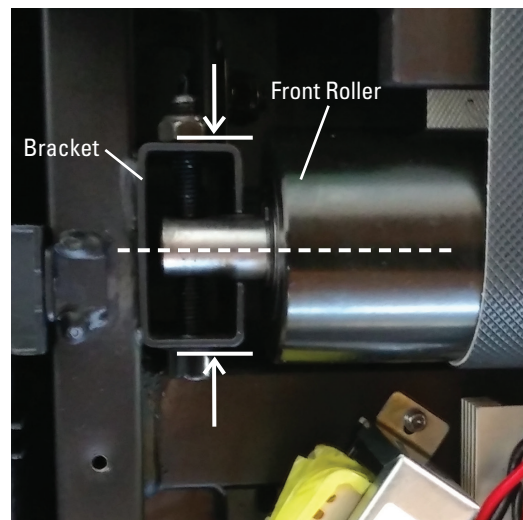

13. With the Motor Assembly loosely attached to the Frame, turn the Belt Tensioner Screw to the previous level. This will tighten the Drive Belt to the previous tension level.

14. Using a 6mm hex wrench, fully tighten the screws that attach the Motor Mount to the Frame.

15. Inspect the Speed Sensor to see if it has been moved during the procedure. If necessary, adjust it to be the appropriate distance from the Drive Pulley.

16. Re-install all remaining parts that were removed in reverse order.

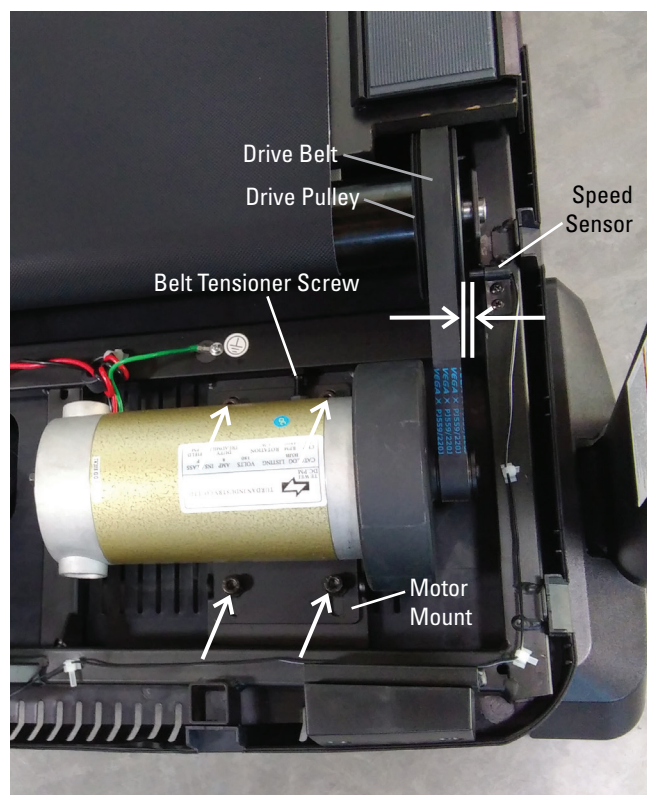

17. Attach the power cord and turn on the Treadmill by flipping the power switch to ON.

18. Attach the power cord and turn on the Treadmill by flipping the power switch to ON.

19. From the Power Up (or Welcome) screen, push and hold down the PAUSE/STOP button and Down arrow button for about 5 seconds to go into the Machine Setting Mode. The Console display will show the TOTAL HOURS screen.

20. Push and hold down the PAUSE/STOP button and Down arrow button for about 5 seconds to go into the Engineering Mode.

21. Push the Down arrow button 12 times until the Console displays “ENTR MCB CLB”.

 **Be sure the area around the Treadmill is clear of all bystanders, children and pets. Be sure there is nothing on or under the Walking Belt, or near the Treadmill.**

22. The Console will display “MCB CALIB”.

23. With the area clear, push the ENTER button. The calibration procedure will begin by automatically moving the Walking Belt.

 **Be sure not to touch or allow anyone else to touch the machine while calibration is occurring.**

24. When calibration is complete, the Console will display “DONE”.

25. Push the PAUSE/STOP button to exit the Engineering Mode.

26. Flip the power switch to OFF. Calibration is now complete for the machine.

27. Final Inspection

Inspect your machine to ensure that all hardware is tight and components are properly assembled.

 **Do not use until the machine has been fully assembled and inspected for correct performance in accordance with the Owner’s Manual.**

**NOTICE:** This document provides instructions for the replacement of the Incline Motor Assembly on the Bowflex™ BXT6 / BXT028 Treadmill.

If you need assistance, please contact Customer Service (if purchased in US/Canada) or your local distributor (if purchased outside US/Canada). To find your local distributor, go to: [www.nautilusinternational.com](http://www.nautilusinternational.com)

 **This icon means a potentially hazardous situation which, if not avoided, could result in death or serious injury. Read and understand all Warnings on this machine.**

Nautilus, Inc., [www.NautilusInc.com](http://www.NautilusInc.com), 5415 Centerpoint Parkway, Groveport, OH 43125 U.S.A. - Customer Service: North America (800) 605-3369, [csnls@nautilus.com](mailto:csnls@nautilus.com) | outside U.S. [www.nautilusinternational.com](http://www.nautilusinternational.com) | Printed in China | © 2018 Nautilus, Inc. | Bowflex and the B logo are trademarks owned or licensed by Nautilus, Inc., registered or otherwise protected by common law in the United States and other nations. | **ORIGINAL DOCUMENT - ENGLISH VERSION ONLY**

### Important Safety Instructions - Before servicing or using this equipment, obey the following warnings:

 **This icon means a potentially hazardous situation which, if not avoided, could result in death or serious injury. Read and understand all Warnings on this machine.**

**⚠ DANGER** To reduce the risk of electrical shock or unsupervised usage of the equipment, always unplug the power cord from the wall outlet and wait 5 minutes before cleaning, maintaining or repairing this machine. Place the power cord in a secure location.

- Read and understand the Part Replacement Procedure before working on the machine. Failure to obey the instructions and safety warnings could cause injury to the service technician or bystanders.
- Keep bystanders, children and pets away from the product being serviced at all times.
- Make sure that the repair is done in an appropriate work space away from foot traffic and exposure to bystanders.
- Disconnect all power and allow to sit for 5 minutes before you service this machine.
- Some components of the equipment can be heavy or awkward. Enlist the service of a second person when you do maintenance steps involving these components. Do not try to do heavy or awkward steps on your own.
- If replacement parts are necessary, use only genuine Nautilus replacement parts and hardware. Failure to use genuine replacement parts can cause a risk to users, keep the machine from operating correctly and will void the warranty.
- Be sure that all warning stickers and instructional placards applied to the product stay present and in good condition when doing maintenance or replacing components. If at any time the Warning labels become loose, unreadable or dislodged, replace the labels. If purchased in US/Canada, contact Customer Service for replacement labels. If purchased outside US/Canada, contact your local distributor for them.
- Do not try to change the design or functionality of the machine being serviced as this can adversely effect user safety and will void the warranty.
- Do not use the machine until all shrouds, instructions, warning labels and correct functionality have been verified and tested for correct performance.

### Tools Required (not included)

#2 Phillips screwdriver



16mm wrench  
(2) 17mm wrenches



**⚠ DANGER** To reduce the risk of electrical shock or unsupervised usage of the equipment, always unplug the power cord from the wall outlet and wait 5 minutes before cleaning, maintaining or repairing this machine. Place the power cord in a secure location.

1. Unplug the power cord from the machine and wait 5 minutes. Place the power cord in a secure location.

2. Using a #2 Phillips screwdriver remove the 4 indicated screws, and two additional screws on the far side, from the Motor Cover and remove it.



3. Using a #2 Phillips screwdriver remove the 2 indicated screws from the MCB Cover and remove it.

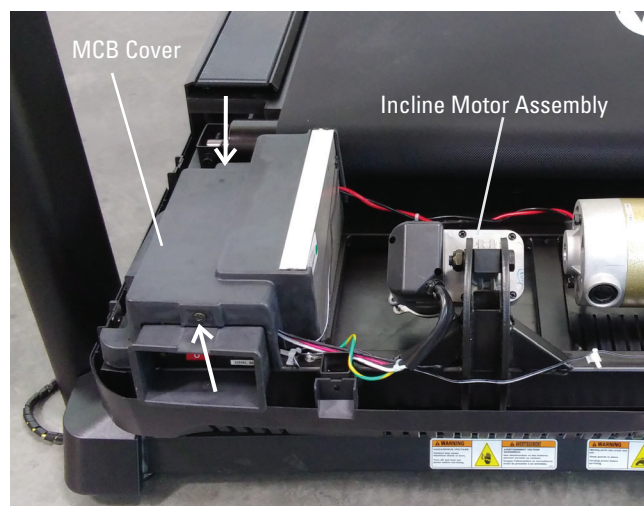

4. Remove the connectors for the Incline Motor Potentiometer and the Incline Motor from the Motor Control Board after noting their locations.

**Note:** Be sure to note where all cables attach for re-assembly.

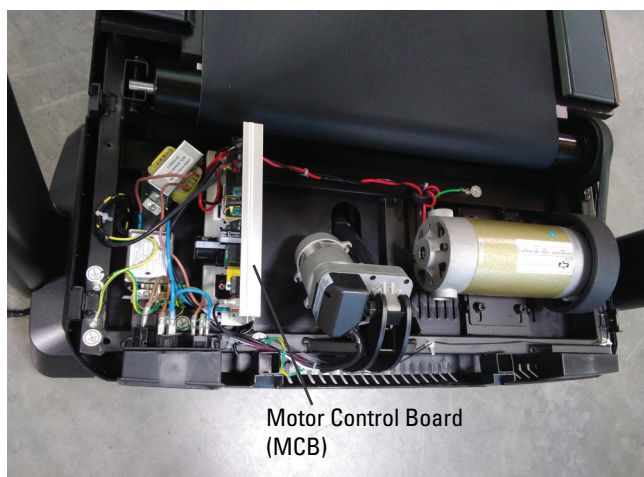



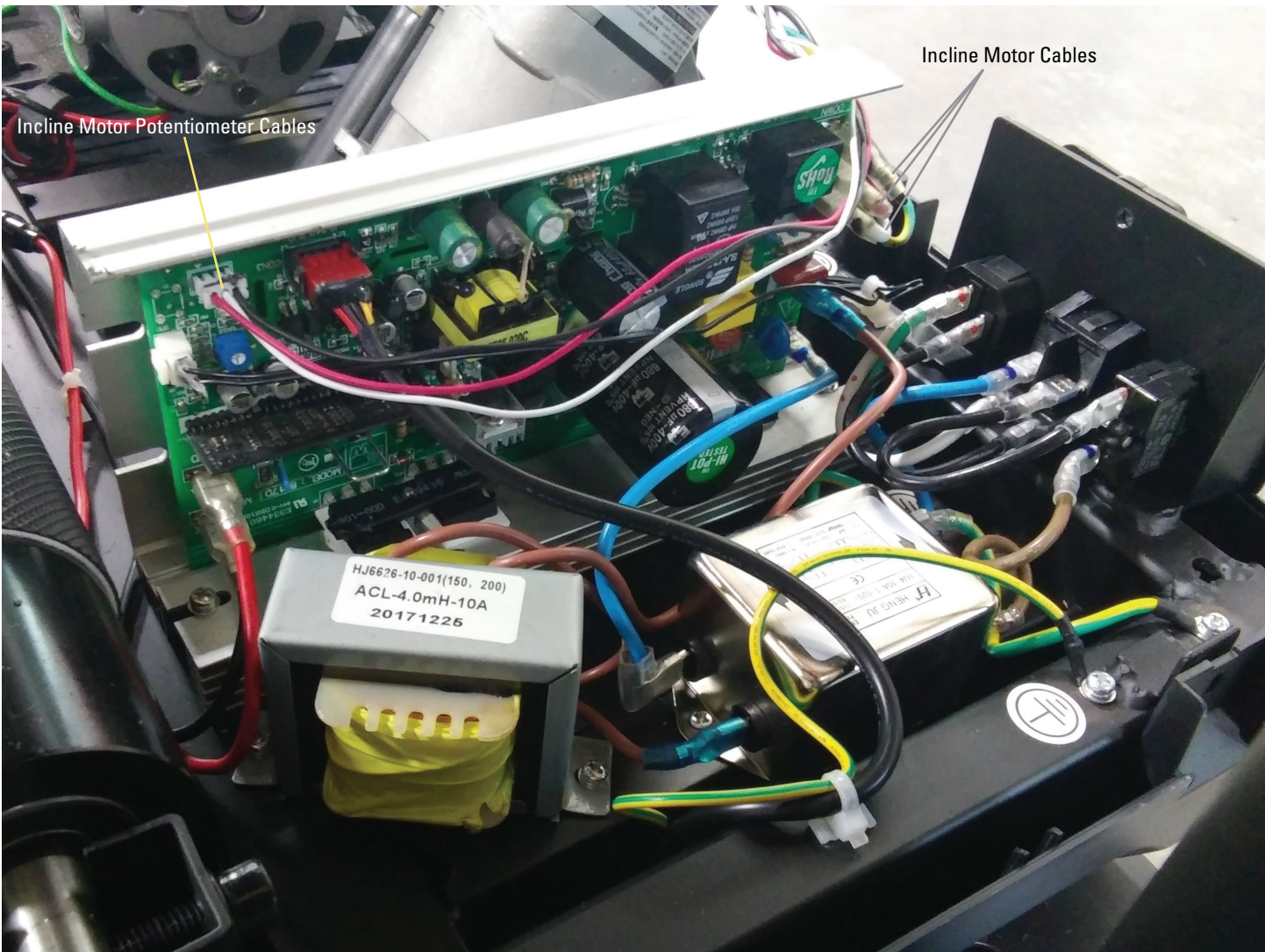
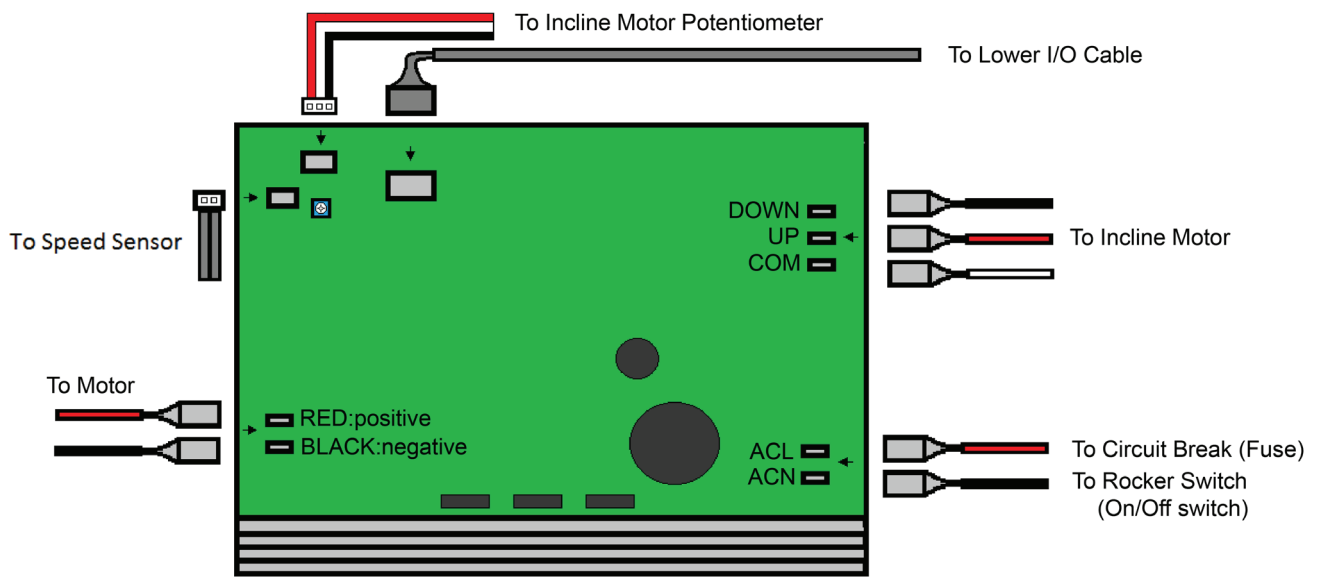

**Note:** The above photo shows the BXT028 machine, with Choke and Filter included.

5. Make sure that there is safe clearance around, on and above the treadmill. Make sure there is no object to spill or cause blockage from the fully folded position.

**!** Be sure there is adequate height clearance for the raised deck.

6. Using the support bar found below the rear of the walking belt, lift the walking deck fully upward and engage the hydraulic lift. Be sure that the hydraulic lift is correctly locked in place. You will hear an audible click when the hydraulic lift shifts into the locked position.

**!** Use proper safety precautions and lifting techniques. Bend your knees and elbows, keep your back straight and pull up equally with both arms. Make sure that your own physical strength is capable of lifting the walking deck until it engages the locking mechanism. Use a second person if necessary.

Do not use the walking belt or rear roller to lift the treadmill. These parts do not lock in place and can abruptly move. Injury to you or damage to the machine can occur.

7. Make sure that the locking mechanism is engaged. Carefully pull back on the walking deck and make sure that it does not move. When you do this, keep clear of movement path in case the treadmill lock is not properly engaged.

**!** Do not lean against the treadmill when it is folded. Do not put items on it that could cause it to become unstable or fall.

8. Make sure that there is safe clearance around, on and above the treadmill to one side. Tilt the machine onto the side being sure not to grasp the Console.

**!** A second person is required to assist with the tilting of the machine. Do not tilt the machine unless the walking deck is in the folded, locked position. Be sure there is adequate clearance for the raised deck. Some components of the equipment can be heavy or awkward. Enlist the service of a second person when you do maintenance steps involving these components. Do not try to do heavy or awkward steps on your own.





9. Using two 17mm wrenches, remove the hardware from the Incline Motor Assembly.



10. Using a 16mm and a 17mm wrench in the Motor Compartment, remove the hardware from the Incline Motor Assembly. Remove the Incline Motor Assembly noting how it extends from the Motor Compartment through to the Incline Weldment.

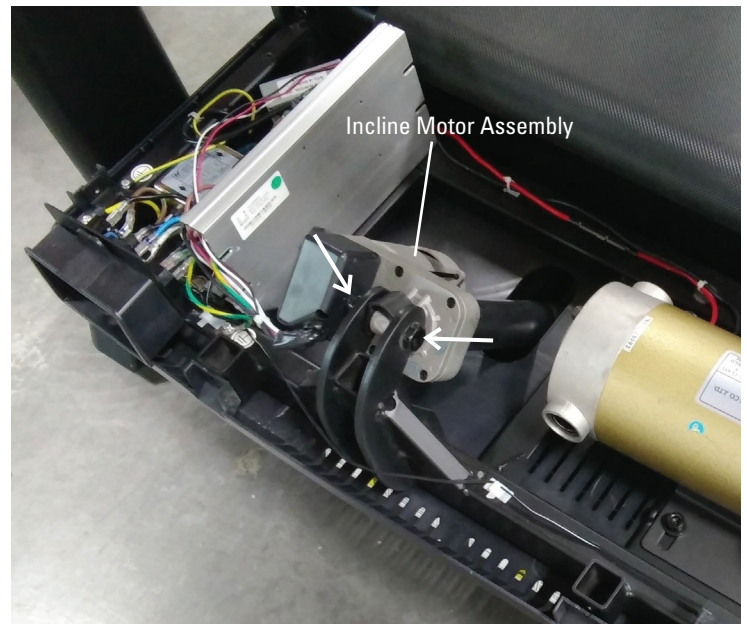

11. Installation of the Incline Motor Assembly is the reverse procedure.

**Note:** Be sure to attach the cables to the proper locations on the Motor Control Board. Do not crimp any cables.

12. Make sure that there is safe clearance beside the treadmill to one side. Make sure there is sufficient space to tilt the machine back upright.

**!** This step requires two people. Be sure there is adequate clearance for the raised deck. Some components of the equipment can be heavy or awkward. Enlist the service of a second person when you do maintenance steps involving these components. Do not try to do heavy or awkward steps on your own.

13. Make sure there is sufficient space to lower the walking deck.

**!** Keep a minimum clearance behind the machine of 79" (2 m) and 24" (0.6 m) on each side. This is the recommended safe distance for access, movement and emergency dismounts from the machine.

14. Make sure there is no object on or around the treadmill to spill or cause blockage from the fully unfolded position.

15. Slightly push the walking deck forward toward the console. With your foot lightly push the top part of the hydraulic lift forward until the locking tube releases and you can pull the walking deck away from the console. Hold up the rear of the walking deck, and move to the side of the machine.



**!** Keep clear of the movement path of the walking deck.

16. The hydraulic lift is set up to drop gradually. Hold onto the walking deck until approximately 2/3 of the movement down. Lower the weight with your legs. Be aware that the walking deck can possibly drop quickly in the last part of the movement.

17. Re-install all remaining parts that were removed in reverse order.

18. Attach the power cord and turn on the Treadmill by flipping the power switch to ON.

19. From the Power Up (or Welcome) screen, push and hold down the PAUSE/STOP button and Down arrow button for about 5 seconds to go into the Machine Setting Mode. The Console display will show the TOTAL HOURS screen.

20. Push and hold down the PAUSE/STOP button and Down arrow button for about 5 seconds to go into the Engineering Mode.

21. Push the Down arrow button 12 times until the Console displays "ENTR MCB CLB".

**!** Be sure the area around the Treadmill is clear of all bystanders, children and pets. Be sure there is nothing on or under the Walking Belt, or near the Treadmill.

22. The Console will display "MCB CALIB".

23. With the area clear, push the ENTER button. The calibration procedure will begin by automatically moving the Walking Belt.

**!** Be sure not to touch or allow anyone else to touch the machine while calibration is occurring.

24. When calibration is complete, the Console will display "DONE".

25. Push the PAUSE/STOP button to exit the Engineering Mode.

26. Flip the power switch to OFF. Calibration is now complete for the machine.



## 27. Final Inspection

Inspect your machine to ensure that all hardware is tight and components are properly assembled.



**Do not use until the machine has been fully assembled and inspected for correct performance in accordance with the Owner's Manual.**

**NOTICE:** This document provides instructions for the replacement of the Lift Shock on the Bowflex™ BXT6 / BXT028 Treadmill.

If you need assistance, please contact Customer Service (if purchased in US/Canada) or your local distributor (if purchased outside US/Canada). To find your local distributor, go to: [www.nautilusinternational.com](http://www.nautilusinternational.com)

 **This icon means a potentially hazardous situation which, if not avoided, could result in death or serious injury. Read and understand all Warnings on this machine.**

Nautilus, Inc., [www.NautilusInc.com](http://www.NautilusInc.com), 5415 Centerpoint Parkway, Groveport, OH 43125 U.S.A. - Customer Service: North America (800) 605-3369, [csnls@nautilus.com](mailto:csnls@nautilus.com) | outside U.S. [www.nautilusinternational.com](http://www.nautilusinternational.com) | Printed in China | © 2020 Nautilus, Inc. | Bowflex and the B logo are trademarks owned or licensed by Nautilus, Inc., registered or otherwise protected by common law in the United States and other nations. | **ORIGINAL DOCUMENT - ENGLISH VERSION ONLY**

### Important Safety Instructions - Before servicing or using this equipment, obey the following warnings:

 **This icon means a potentially hazardous situation which, if not avoided, could result in death or serious injury. Read and understand all Warnings on this machine.**

**⚠ DANGER** To reduce the risk of electrical shock or unsupervised usage of the equipment, always unplug the power cord from the wall outlet and wait 5 minutes before cleaning, maintaining or repairing this machine. Place the power cord in a secure location.

- Read and understand the Part Replacement Procedure before working on the machine. Failure to obey the instructions and safety warnings could cause injury to the service technician or bystanders.
- Keep bystanders, children and pets away from the product being serviced at all times.
- Make sure that the repair is done in an appropriate work space away from foot traffic and exposure to bystanders.
- Disconnect all power and allow to sit for 5 minutes before you service this machine.
- Some components of the equipment can be heavy or awkward. Enlist the service of a second person when you do maintenance steps involving these components. Do not try to do heavy or awkward steps on your own.
- If replacement parts are necessary, use only genuine Nautilus replacement parts and hardware. Failure to use genuine replacement parts can cause a risk to users, keep the machine from operating correctly and will void the warranty.
- Be sure that all warning stickers and instructional placards applied to the product stay present and in good condition when doing maintenance or replacing components. If at any time the Warning labels become loose, unreadable or dislodged, replace the labels. If purchased in US/Canada, contact Customer Service for replacement labels. If purchased outside US/Canada, contact your local distributor for them.
- Do not try to change the design or functionality of the machine being serviced as this can adversely effect user safety and will void the warranty.
- Do not use the machine until all shrouds, instructions, warning labels and correct functionality have been verified and tested for correct performance.

### Tools Required (not included)

6mm hex wrench



13mm wrench

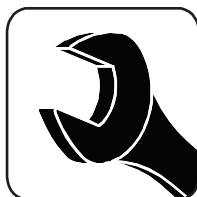

**⚠ DANGER** To reduce the risk of electrical shock or unsupervised usage of the equipment, always unplug the power cord from the wall outlet and wait 5 minutes before cleaning, maintaining or repairing this machine. Place the power cord in a secure location.

1. Unplug the power cord from the machine and wait 5 minutes. Place the power cord in a secure location.

2. Make sure that there is safe clearance around, on and above the treadmill. Make sure there is no object to spill or cause blockage from the fully folded position.

**⚠** Be sure there is adequate height clearance for the raised deck.

3. Using the support bar found below the rear of the walking belt, lift the walking deck fully upward and engage the hydraulic lift. Be sure that the hydraulic lift is correctly locked in place. You will hear an audible click when the hydraulic lift shifts into the locked position.

**⚠** Use proper safety precautions and lifting techniques. Bend your knees and elbows, keep your back straight and pull up equally with both arms. Make sure that your own physical strength is capable of lifting the walking deck until it engages the locking mechanism. Use a second person if necessary.

Do not use the walking belt or rear roller to lift the treadmill. These parts do not lock in place and can abruptly move. Injury to you or damage to the machine can occur.

4. Make sure that the locking mechanism is engaged. Carefully pull back on the walking deck and make sure that it does not move. When you do this, keep clear of movement path in case the treadmill lock is not properly engaged.

**⚠** Do not lean against the treadmill when it is folded. Do not put items on it that could cause it to become unstable or fall.

5. Make sure that there is safe clearance around, on and above the treadmill to one side. Tilt the machine onto the side being sure not to grasp the Console.

**⚠** A second person is required to assist with the tilting of the machine. Do not tilt the machine unless the walking deck is in the folded, locked position. Be sure there is adequate clearance for the raised deck. Some components of the equipment can be heavy or awkward. Enlist the service of a second person when you do maintenance steps involving these components. Do not try to do heavy or awkward steps on your own.



6. Using a 13mm wrench and a 6mm hex wrench, remove the indicated hardware (with ovals) from the Lift Shock Assembly.

**!** Be aware that when the Lift Shock is released from the Frame Assembly, the Lift Shock and Base Frame Weldment may abruptly move. Be sure to keep clear of any potential pinch opportunities from this motion.

7. Remove the old Lift Shock and attach the new Lift Shock.

8. Make sure there is sufficient space to tilt the machine back upright and that the area is clear.

**!** This step requires two people. Be sure there is adequate clearance for the raised deck. Some components of the equipment can be heavy or awkward. Enlist the service of a second person when you do maintenance steps involving these components. Do not try to do heavy or awkward steps on your own.

9. Make sure there is sufficient space to lower the walking deck.

**!** Keep a minimum clearance behind the machine of 79" (2 m) and 24" (0.6 m) on each side. This is the recommended safe distance for access, movement and emergency dismounts from the machine.

10. Make sure there is no object on or around the treadmill to spill or cause blockage from the fully unfolded position.

11. Slightly push the walking deck forward toward the console. With your foot lightly push the top part of the hydraulic lift forward until the locking tube releases and you can pull the walking deck away from the console. Hold up the rear of the walking deck, and move to the side of the machine.

**!** Keep clear of the movement path of the walking deck.

12. The hydraulic lift is set up to drop gradually. Hold onto the walking deck until approximately 2/3 of the movement down. Lower the weight with your legs. Be aware that the walking deck can possibly drop quickly in the last part of the movement.

13. Re-install all remaining parts that were removed in reverse order.



#### 14. Final Inspection

Inspect your machine to ensure that all hardware is tight and components are properly assembled.



**Do not use until the machine has been fully assembled and inspected for correct performance in accordance with the Owner's Manual.**

**NOTICE:** This document provides instructions for the replacement of the Lower Input/Output (I/O) Cable on the Bowflex™ BXT6 / BXT028 Treadmill.

If you need assistance, please contact Customer Service (if purchased in US/Canada) or your local distributor (if purchased outside US/Canada). To find your local distributor, go to: [www.nautilusinternational.com](http://www.nautilusinternational.com)

 **This icon means a potentially hazardous situation which, if not avoided, could result in death or serious injury. Read and understand all Warnings on this machine.**

Nautilus, Inc., [www.NautilusInc.com](http://www.NautilusInc.com), 5415 Centerpoint Parkway, Groveport, OH 43125 U.S.A. - Customer Service: North America (800) 605-3369, [csnls@nautilus.com](mailto:csnls@nautilus.com) | outside U.S. [www.nautilusinternational.com](http://www.nautilusinternational.com) | Printed in China | © 2018 Nautilus, Inc. | Bowflex and the B logo are trademarks owned or licensed by Nautilus, Inc., registered or otherwise protected by common law in the United States and other nations. | **ORIGINAL DOCUMENT - ENGLISH VERSION ONLY**

### Important Safety Instructions - Before servicing or using this equipment, obey the following warnings:

 **This icon means a potentially hazardous situation which, if not avoided, could result in death or serious injury. Read and understand all Warnings on this machine.**

**⚠ DANGER** To reduce the risk of electrical shock or unsupervised usage of the equipment, always unplug the power cord from the wall outlet and wait 5 minutes before cleaning, maintaining or repairing this machine. Place the power cord in a secure location.

- Read and understand the Part Replacement Procedure before working on the machine. Failure to obey the instructions and safety warnings could cause injury to the service technician or bystanders.
- Keep bystanders, children and pets away from the product being serviced at all times.
- Make sure that the repair is done in an appropriate work space away from foot traffic and exposure to bystanders.
- Disconnect all power and allow to sit for 5 minutes before you service this machine.
- Some components of the equipment can be heavy or awkward. Enlist the service of a second person when you do maintenance steps involving these components. Do not try to do heavy or awkward steps on your own.
- If replacement parts are necessary, use only genuine Nautilus replacement parts and hardware. Failure to use genuine replacement parts can cause a risk to users, keep the machine from operating correctly and will void the warranty.
- Be sure that all warning stickers and instructional placards applied to the product stay present and in good condition when doing maintenance or replacing components. If at any time the Warning labels become loose, unreadable or dislodged, replace the labels. If purchased in US/Canada, contact Customer Service for replacement labels. If purchased outside US/Canada, contact your local distributor for them.
- Do not try to change the design or functionality of the machine being serviced as this can adversely effect user safety and will void the warranty.
- Do not use the machine until all shrouds, instructions, warning labels and correct functionality have been verified and tested for correct performance.

### Tools Required (not included)

#2 Phillips screwdriver

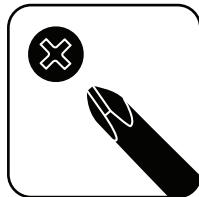

6mm hex wrench





**⚠ DANGER** To reduce the risk of electrical shock or unsupervised usage of the equipment, always unplug the power cord from the wall outlet and wait 5 minutes before cleaning, maintaining or repairing this machine. Place the power cord in a secure location.

1. Unplug the power cord from the machine and wait 5 minutes. Place the power cord in a secure location.

2. Using a #2 Phillips screwdriver remove the 4 indicated screws, and two additional screws on the far side, from the Motor Cover and remove it.



3. Using a #2 Phillips screwdriver remove the 2 indicated screws from the MCB Cover and remove it.

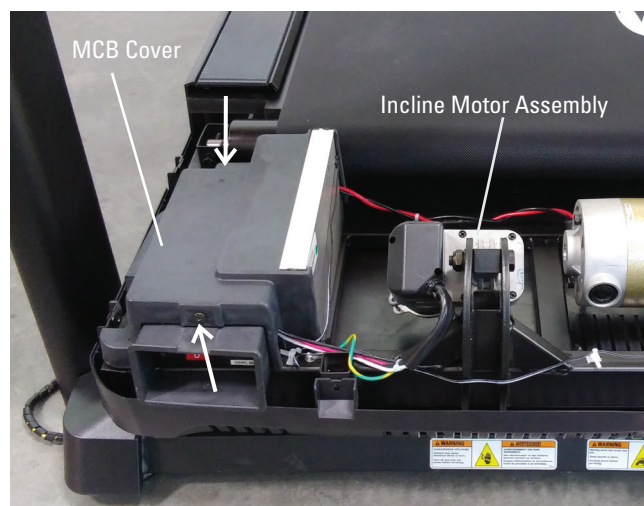

4. Remove the connectors for the Lower Input/Output (I/O) Cable from the Motor Control Board after noting its location.

**Note:** Be sure to note where all cables attach for re-assembly.

5. Using a #2 Phillips screwdriver, disconnect the Grounding Cable from the Frame Assembly.

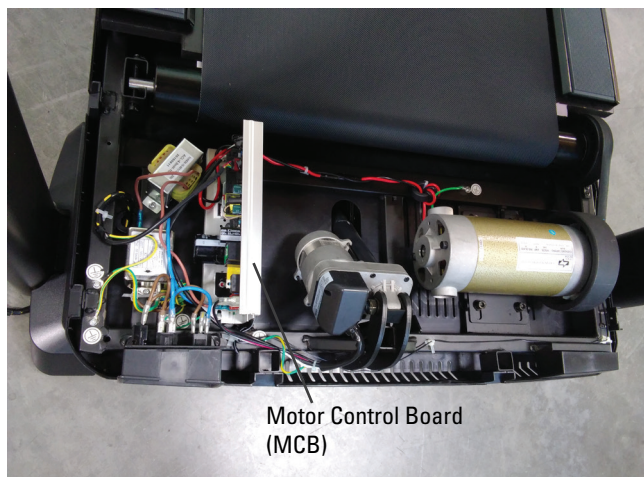

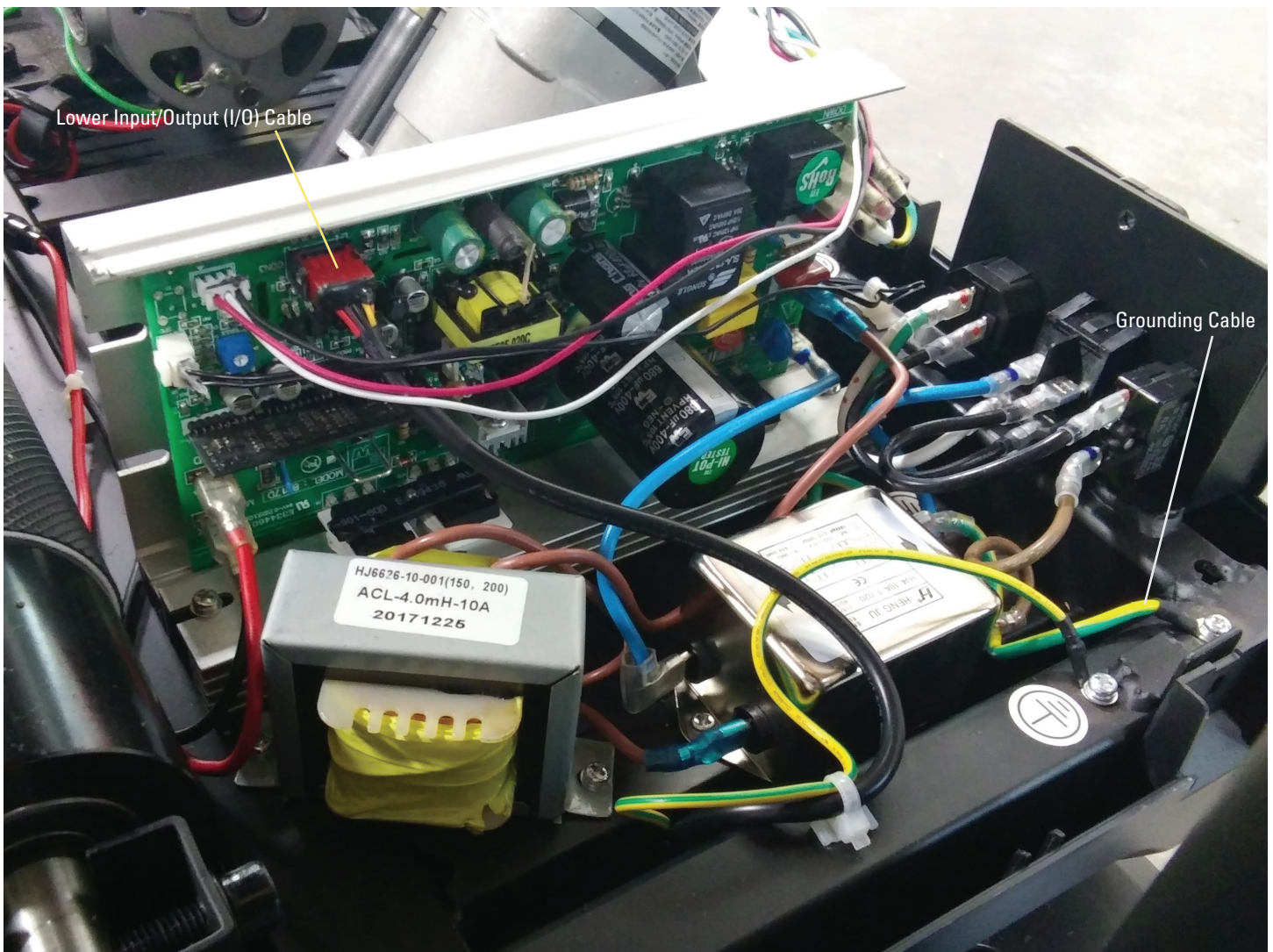
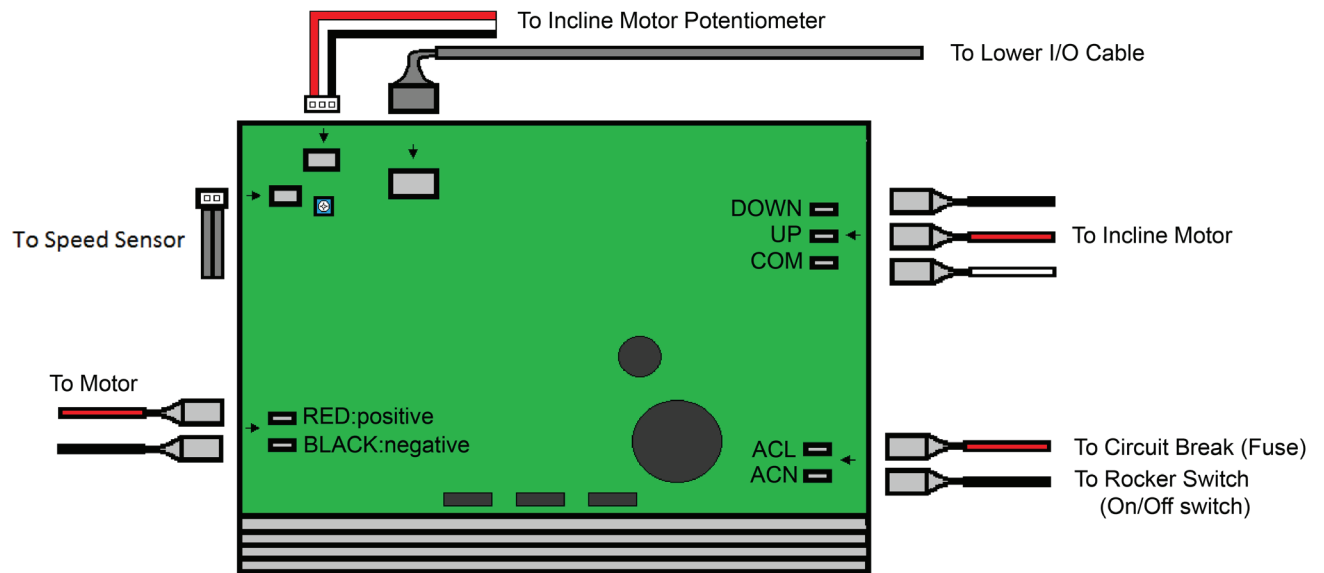

**Note:** The above photo shows the BXT028 machine, with Choke and Filter included.



6. Make sure that there is safe clearance around, on and above the treadmill. Make sure there is no object to spill or cause blockage from the fully folded position.

**!** Be sure there is adequate height clearance for the raised deck.

7. Using the support bar found below the rear of the walking belt, lift the walking deck fully upward and engage the hydraulic lift. Be sure that the hydraulic lift is correctly locked in place. You will hear an audible click when the hydraulic lift shifts into the locked position.

**!** Use proper safety precautions and lifting techniques. Bend your knees and elbows, keep your back straight and pull up equally with both arms. Make sure that your own physical strength is capable of lifting the walking deck until it engages the locking mechanism. Use a second person if necessary.

Do not use the walking belt or rear roller to lift the treadmill. These parts do not lock in place and can abruptly move. Injury to you or damage to the machine can occur.

8. Make sure that the locking mechanism is engaged. Carefully pull back on the walking deck and make sure that it does not move. When you do this, keep clear of movement path in case the treadmill lock is not properly engaged.

**!** Do not lean against the treadmill when it is folded. Do not put items on it that could cause it to become unstable or fall.

9. Safely tilt the right side of the machine up, and place an incompressible block or book under the Base Assembly.

10. From the bottom of the Right Upright, gently remove the Input/Output Connectors and disconnect them.

**Note:** Do not crimp cables.

11. Decide which of the two Cables is the one being replaced, the Lower I/O Cable.

12. Connect the new Lower I/O Cable to the Middle I/O Cable.

13. Connect the other end of the new Lower I/O Cable to the old Lower I/O Cable.

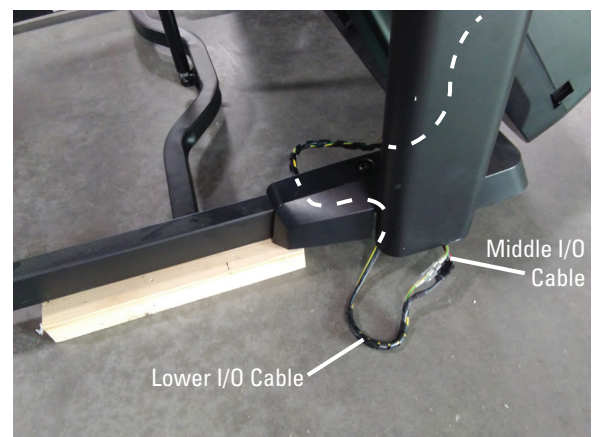

14. Gently pull the old Lower I/O Cable toward the MCB, routing the new Lower I/O Cable through the Frame Assembly.

**Note:** Be sure the cable does not crimp when being routed.

15. Disconnect the old Lower I/O Cable, and dispose of it appropriately.

16. Connect the new Lower I/O Cable to the MCB, and the Grounding Cable to the Frame Assembly.

17. Re-install all remaining parts that were removed in reverse order. Be sure the Cables are safely tucked into the Right Upright.

18. Safely tilt the right side of the machine up, remove the incompressible block or book from under the Base Assembly, and safely lower the machine.

19. Make sure there is sufficient space to lower the walking deck.

**!** **Keep a minimum clearance behind the machine of 79" (2 m) and 24" (0.6 m) on each side. This is the recommended safe distance for access, movement and emergency dismounts from the machine.**

20. Make sure there is no object on or around the treadmill to spill or cause blockage from the fully unfolded position.

21. Slightly push the walking deck forward toward the console. With your foot lightly push the top part of the hydraulic lift forward until the locking tube releases and you can pull the walking deck away from the console. Hold up the rear of the walking deck, and move to the side of the machine.

**!** **Keep clear of the movement path of the walking deck.**

22. The hydraulic lift is set up to drop gradually. Hold onto the walking deck until approximately 2/3 of the movement down. Lower the weight with your legs. Be aware that the walking deck can possibly drop quickly in the last part of the movement.

23. Final Inspection

Inspect your machine to ensure that all hardware is tight and components are properly assembled.

**!** **Do not use until the machine has been fully assembled and inspected for correct performance in accordance with the Owner's Manual.**

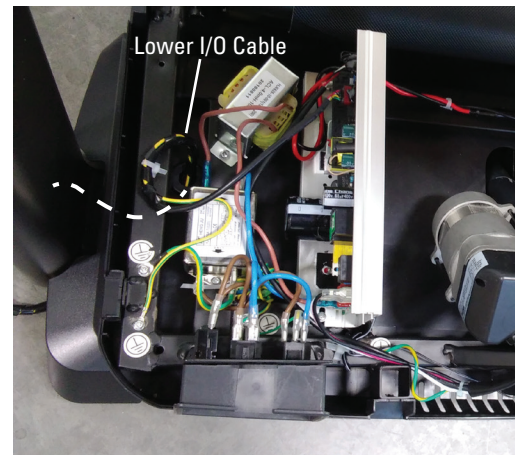

**NOTICE:** This document provides instructions for the replacement of the Middle I/O Cable on the Bowflex™ BXT6 / BXT028 Treadmill.

If you need assistance, please contact Customer Service (if purchased in US/Canada) or your local distributor (if purchased outside US/Canada). To find your local distributor, go to: [www.nautilusinternational.com](http://www.nautilusinternational.com)

 This icon means a potentially hazardous situation which, if not avoided, could result in death or serious injury. Read and understand all Warnings on this machine.

Nautilus, Inc., [www.NautilusInc.com](http://www.NautilusInc.com), 5415 Centerpoint Parkway, Groveport, OH 43125 U.S.A. - Customer Service: North America (800) 605-3369, [csnls@nautilus.com](mailto:csnls@nautilus.com) | outside U.S. [www.nautilusinternational.com](http://www.nautilusinternational.com) | Printed in China | © 2018 Nautilus, Inc. | Bowflex and the B logo are trademarks owned or licensed by Nautilus, Inc., registered or otherwise protected by common law in the United States and other nations. | **ORIGINAL DOCUMENT - ENGLISH VERSION ONLY**

### Important Safety Instructions - Before servicing or using this equipment, obey the following warnings:

 This icon means a potentially hazardous situation which, if not avoided, could result in death or serious injury. Read and understand all Warnings on this machine.

**⚠ DANGER** To reduce the risk of electrical shock or unsupervised usage of the equipment, always unplug the power cord from the wall outlet and wait 5 minutes before cleaning, maintaining or repairing this machine. Place the power cord in a secure location.

- Read and understand the Part Replacement Procedure before working on the machine. Failure to obey the instructions and safety warnings could cause injury to the service technician or bystanders.
- Keep bystanders, children and pets away from the product being serviced at all times.
- Make sure that the repair is done in an appropriate work space away from foot traffic and exposure to bystanders.
- Disconnect all power and allow to sit for 5 minutes before you service this machine.
- Some components of the equipment can be heavy or awkward. Enlist the service of a second person when you do maintenance steps involving these components. Do not try to do heavy or awkward steps on your own.
- If replacement parts are necessary, use only genuine Nautilus replacement parts and hardware. Failure to use genuine replacement parts can cause a risk to users, keep the machine from operating correctly and will void the warranty.
- Be sure that all warning stickers and instructional placards applied to the product stay present and in good condition when doing maintenance or replacing components. If at any time the Warning labels become loose, unreadable or dislodged, replace the labels. If purchased in US/Canada, contact Customer Service for replacement labels. If purchased outside US/Canada, contact your local distributor for them.
- Do not try to change the design or functionality of the machine being serviced as this can adversely effect user safety and will void the warranty.
- Do not use the machine until all shrouds, instructions, warning labels and correct functionality have been verified and tested for correct performance.

### Tools Required (not included)

#2 Phillips screwdriver



Incompressible wood block or book (at least 4" in height)



**⚠ DANGER**

To reduce the risk of electrical shock or unsupervised usage of the equipment, always unplug the power cord from the wall outlet and wait 5 minutes before cleaning, maintaining or repairing this machine. Place the power cord in a secure location.

1. Unplug the power cord from the machine and wait 5 minutes. Place the power cord in a secure location.

2. . Using a #2 Phillips screwdriver, remove the 4 indicated screws (by arrows) from Lower Junction Covers.

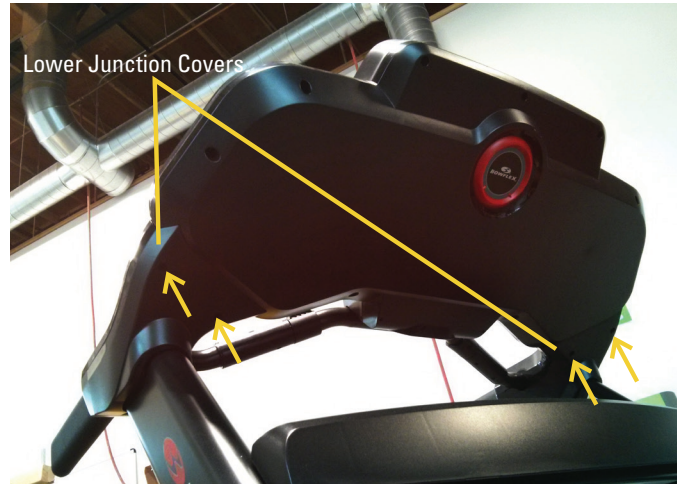

3. The Upper Junction Covers are released in two steps~ the inner snaps followed by the outer snap. From the outside of the machine, gently pinch both of the inside snaps (indicated with ovals) and roll the Upper Junction Cover up and outward from the machine.

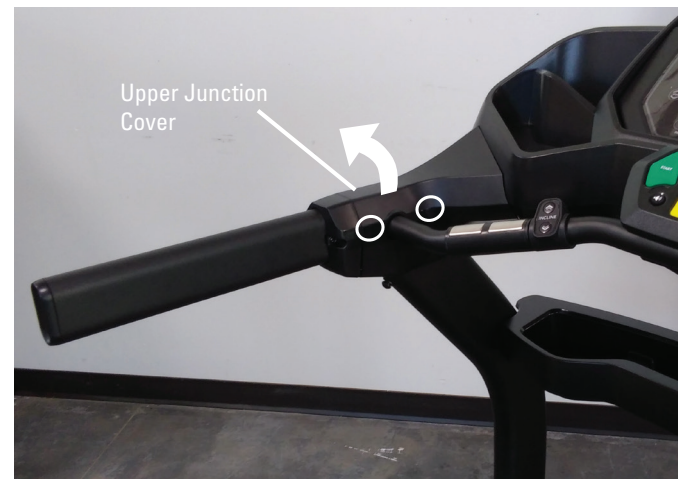

4. With the inner snaps of the Upper junction Covers released, gently pinch the outer snap (indicated by oval) to release the Upper Junction Cover.

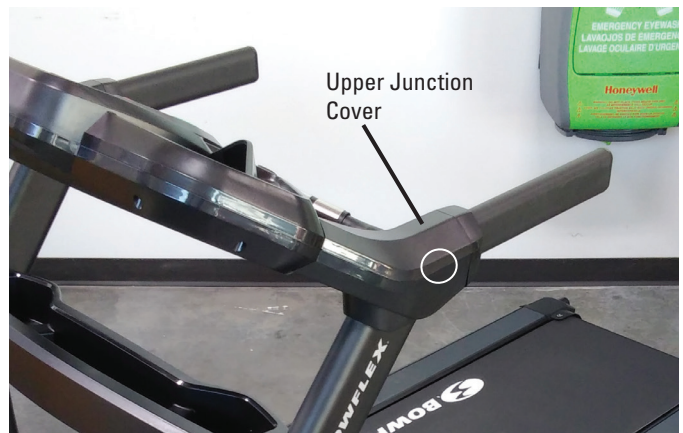



5. Make sure that there is safe clearance around, on and above the treadmill. Make sure there is no object to spill or cause blockage from the fully folded position.

**!** Be sure there is adequate height clearance for the raised deck.

6. Using the support bar found below the rear of the walking belt, lift the walking deck fully upward and engage the hydraulic lift. Be sure that the hydraulic lift is correctly locked in place. You will hear an audible click when the hydraulic lift shifts into the locked position.

**!** Use proper safety precautions and lifting techniques. Bend your knees and elbows, keep your back straight and pull up equally with both arms. Make sure that your own physical strength is capable of lifting the walking deck until it engages the locking mechanism. Use a second person if necessary.

**Do not use the walking belt or rear roller to lift the treadmill. These parts do not lock in place and can abruptly move. Injury to you or damage to the machine can occur.**

7. Make sure that the locking mechanism is engaged. Carefully pull back on the walking deck and make sure that it does not move. When you do this, keep clear of movement path in case the treadmill lock is not properly engaged.

**!** Do not lean against the treadmill when it is folded. Do not put items on it that could cause it to become unstable or fall.

8. Safely tilt the right side of the machine up, and place an incompressible block or book under the Base Assembly.

9. From the bottom of the Right Upright, gently remove the Input/Output Connectors and disconnect them.

**Note:** Do not crimp cables.

10. Decide which of the two Cables is the one being replaced, the Middle I/O Cable.

11. Connect the new Middle I/O Cable to the Lower I/O Cable.

12. Connect the other end of the new Middle I/O Cable to the old Middle I/O Cable.

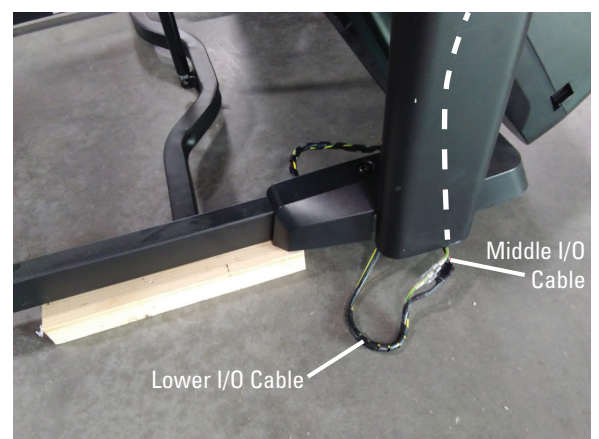
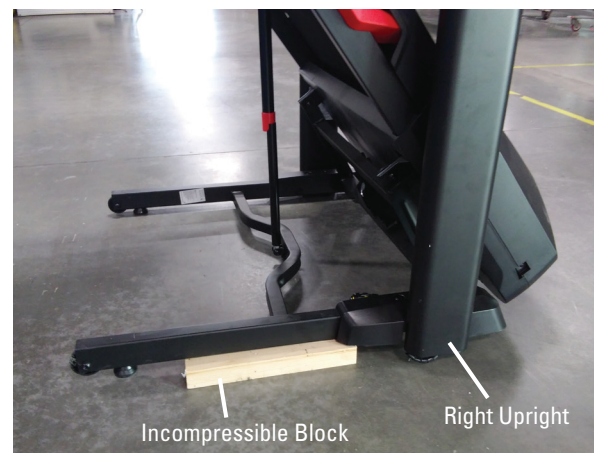

13. Disconnect the old Middle I/O Cable from the Upper I/O Cable at the top of the Right Upright.

**Note:** Be sure not to allow the old Middle I/O Cable to fall down into the Right Upright.

14. Gently pull the old Middle I/O Cable from the Right Upright, routing the new I/O Cable through the Right Upright.

**Note:** Be sure the cable does not crimp when being routed.

15. Disconnect the old Middle I/O Cable, and dispose of it appropriately.

16. Connect the new Middle I/O Cable to the Upper I/O Cable.

17. Re-install all remaining parts that were removed in reverse order. Be sure the Cables are safely tucked into the Right Upright.

18. Safely tilt the right side of the machine up, remove the incompressible block or book from under the Base Assembly, and safely lower the machine.

19. Make sure there is sufficient space to lower the walking deck.

**⚠ Keep a minimum clearance behind the machine of 79" (2 m) and 24" (0.6 m) on each side. This is the recommended safe distance for access, movement and emergency dismounts from the machine.**

20. Make sure there is no object on or around the treadmill to spill or cause blockage from the fully unfolded position.

21. Slightly push the walking deck forward toward the console. With your foot lightly push the top part of the hydraulic lift forward until the locking tube releases and you can pull the walking deck away from the console. Hold up the rear of the walking deck, and move to the side of the machine.

**⚠ Keep clear of the movement path of the walking deck.**

22. The hydraulic lift is set up to drop gradually. Hold onto the walking deck until approximately 2/3 of the movement down. Lower the weight with your legs. Be aware that the walking deck can possibly drop quickly in the last part of the movement.



### 23. Final Inspection

Inspect your machine to ensure that all hardware is tight and components are properly assembled.



**Do not use until the machine has been fully assembled and inspected for correct performance in accordance with the Owner's Manual.**

**NOTICE:** This document provides instructions for the replacement of the Motor on the Bowflex™ BXT6 / BXT028 Treadmill.

If you need assistance, please contact Customer Service (if purchased in US/Canada) or your local distributor (if purchased outside US/Canada). To find your local distributor, go to: [www.nautilusinternational.com](http://www.nautilusinternational.com)

**This icon means a potentially hazardous situation which, if not avoided, could result in death or serious injury. Read and understand all Warnings on this machine.**

Nautilus, Inc., [www.NautilusInc.com](http://www.NautilusInc.com), 5415 Centerpoint Parkway, Groveport, OH 43125 U.S.A. - Customer Service: North America (800) 605-3369, [csnls@nautilus.com](mailto:csnls@nautilus.com) | outside U.S. [www.nautilusinternational.com](http://www.nautilusinternational.com) | Printed in China | © 2020 Nautilus, Inc. | Bowflex and the B logo are trademarks owned or licensed by Nautilus, Inc., registered or otherwise protected by common law in the United States and other nations. | **ORIGINAL DOCUMENT - ENGLISH VERSION ONLY**

### Important Safety Instructions - Before servicing or using this equipment, obey the following warnings:

**This icon means a potentially hazardous situation which, if not avoided, could result in death or serious injury. Read and understand all Warnings on this machine.**

**⚠ DANGER** To reduce the risk of electrical shock or unsupervised usage of the equipment, always unplug the power cord from the wall outlet and wait 5 minutes before cleaning, maintaining or repairing this machine. Place the power cord in a secure location.

- Read and understand the Part Replacement Procedure before working on the machine. Failure to obey the instructions and safety warnings could cause injury to the service technician or bystanders.
- Keep bystanders, children and pets away from the product being serviced at all times.
- Make sure that the repair is done in an appropriate work space away from foot traffic and exposure to bystanders.
- Disconnect all power and allow to sit for 5 minutes before you service this machine.
- Some components of the equipment can be heavy or awkward. Enlist the service of a second person when you do maintenance steps involving these components. Do not try to do heavy or awkward steps on your own.
- If replacement parts are necessary, use only genuine Nautilus replacement parts and hardware. Failure to use genuine replacement parts can cause a risk to users, keep the machine from operating correctly and will void the warranty.
- Be sure that all warning stickers and instructional placards applied to the product stay present and in good condition when doing maintenance or replacing components. If at any time the Warning labels become loose, unreadable or dislodged, replace the labels. If purchased in US/Canada, contact Customer Service for replacement labels. If purchased outside US/Canada, contact your local distributor for them.
- Do not try to change the design or functionality of the machine being serviced as this can adversely effect user safety and will void the warranty.
- Do not use the machine until all shrouds, instructions, warning labels and correct functionality have been verified and tested for correct performance.

#### Tools Required (not included)

#2 Phillips screwdriver

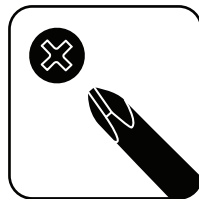

6mm Hex Wrench



13mm Wrench

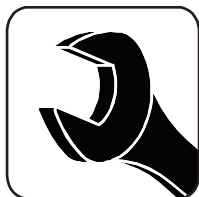



**⚠ DANGER** To reduce the risk of electrical shock or unsupervised usage of the equipment, always unplug the power cord from the wall outlet and wait 5 minutes before cleaning, maintaining or repairing this machine. Place the power cord in a secure location.

1. Unplug the power cord from the machine and wait 5 minutes. Place the power cord in a secure location.

2. Using a #2 Phillips screwdriver remove the 4 indicated screws, and two additional screws on the far side, from the Motor Cover and remove it.



3. Using a #2 Phillips screwdriver remove the 2 indicated screws from the MCB Cover and remove it.

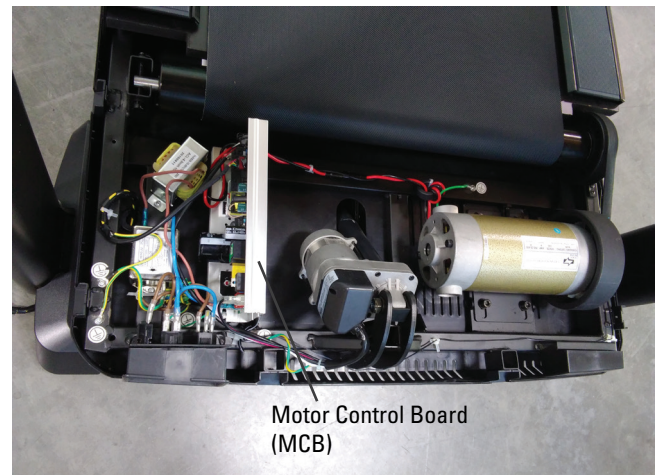
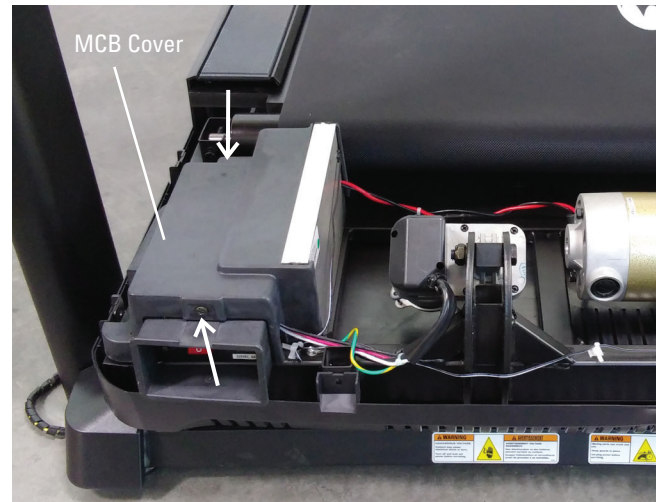

4. Remove the connectors for the Motor from the Motor Control Board after noting their locations.

**Note:** Be sure to note where all cables attach for re-assembly.

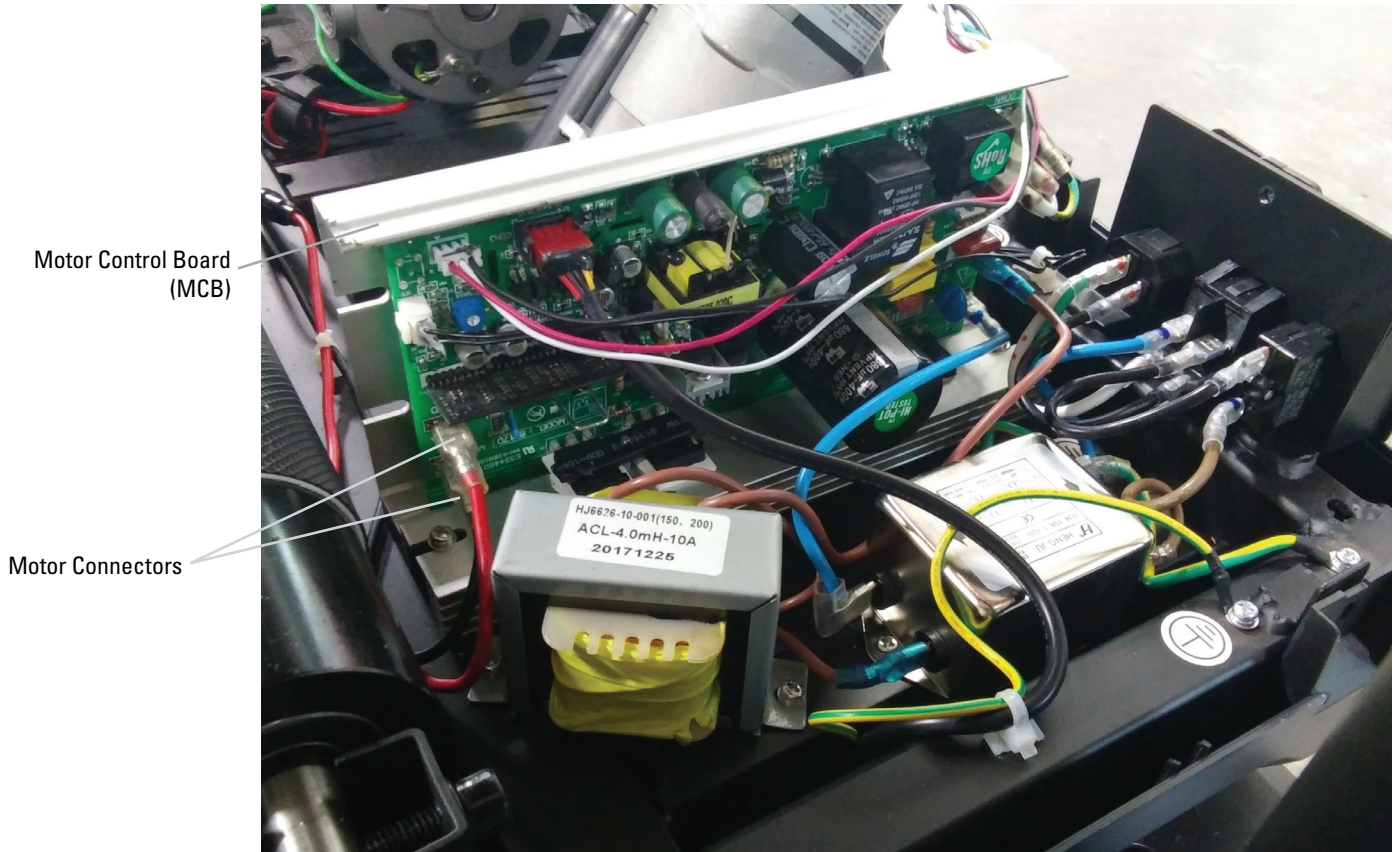

**Note:** The above photo shows the BXT028 machine, with Choke and Filter included.

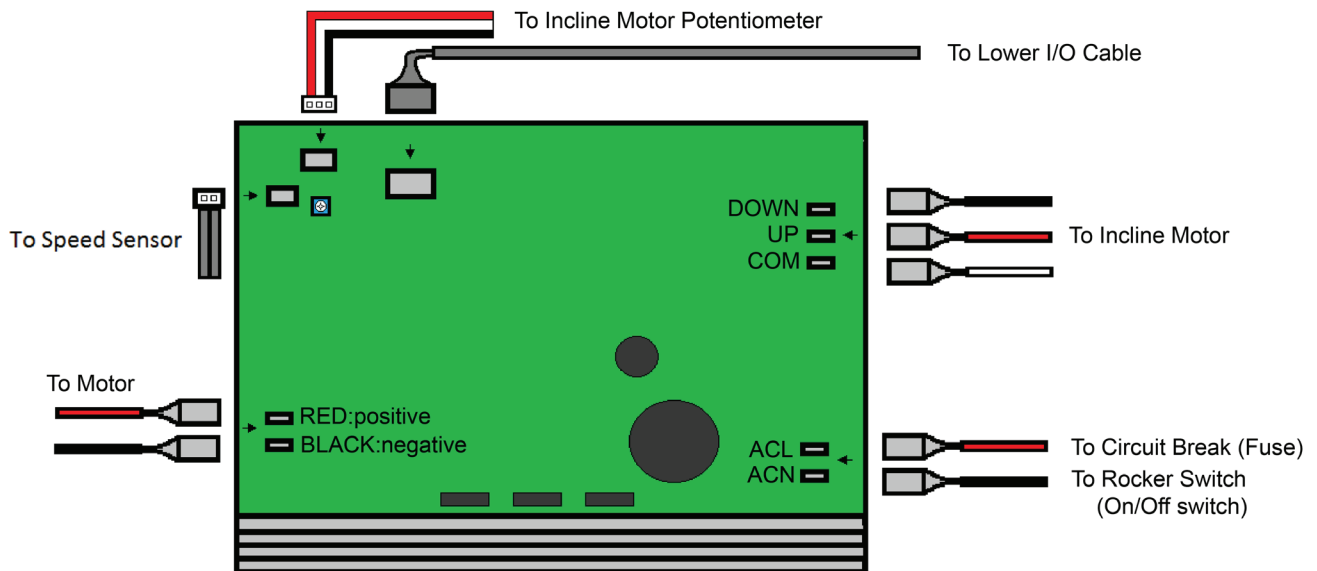



5. Using a #2 Phillips screwdriver, disconnect the Motor Ground Wire from the Frame.
6. Using a 6mm hex wrench, loosen the indicated screws (by arrows) on the Motor Mount.
7. Using a 13mm Open Ended Wrench, rotate the Belt Tensioner Screw enough to loosen the Drive Belt.  
**Note:** To assist with reassembly, be sure to record the number of threads exposed before loosening.
8. Using a 6mm hex wrench, remove the indicated screws (by arrows) from the Motor Mount. Remove the Drive Belt and rotate the Motor Assembly exposing the Motor Mount.
9. Cut the 3 Zip-Ties that secure the Motor Cables.

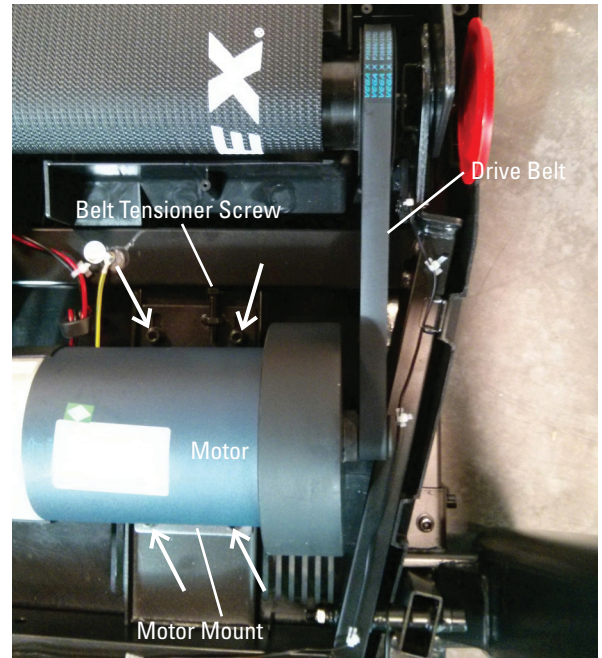

10. Using a 6mm hex wrench, remove the indicated hardware from the Motor Mount and remove the old Motor.

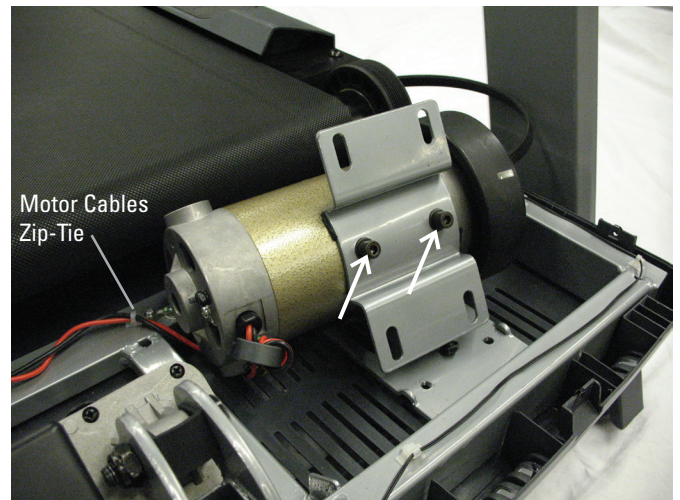

11. Attach the Motor Mount to the new Motor. Be sure the Belt Tensioner Screw is properly oriented toward the rear of the machine when the Motor is re-installed.

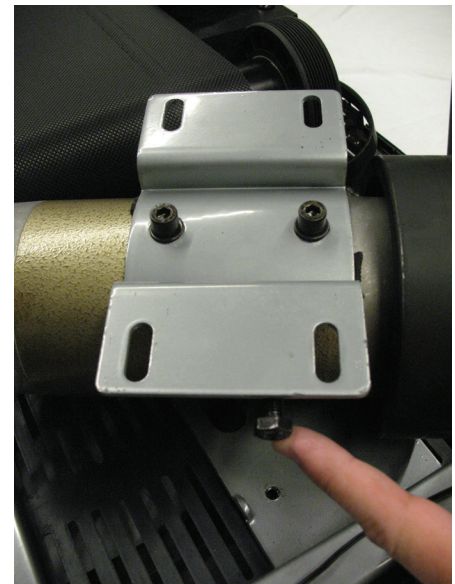

12. Lightly attach the Motor Assembly to the Frame. Be sure to only finger tighten the hardware.

13. Loop the Drive Belt onto the Motor Pulley. With the Drive Belt looped onto the Motor, carefully roll the Drive Belt onto the Drive Pulley.

14. Wrap the new Drive Belt around the Motor Pulley. Start the Drive Belt on the Drive Pulley and roll it in a clockwise motion. Be sure the Belt does not come off of the Motor Pulley.

 **Keep fingers out of any pinch opportunities when turning the Pulleys.**

15. Roll the Drive Pulley clockwise until the Drive Belt is fully installed. Continue to roll the Belt forward while adding side pressure with fingers to align as necessary.

16. With the Motor Assembly loosely attached to the Frame, turn the Belt Tensioner Screw to the previous level. This will tighten the Drive Belt to the previous tension level.

17. Using a 6mm hex wrench, fully tighten the screws that attach the Motor Assembly to the Frame.

18. Connect the Motor Connectors to the Motor Control Board following the previous route.

**Note:** Be sure to attach the cables to the proper locations on the Motor Control Board. Do not crimp any cables.

19. Secure the Motor Cables using the replacement Zip-Ties.

20. Re-install all remaining parts that were removed in reverse order.

21. Attach the power cord and turn on the Treadmill by flipping the power switch to ON.

22. From the Power Up (or Welcome) screen, push and hold down the PAUSE/STOP button and Down arrow button for about 5 seconds to go into the Machine Setting Mode. The Console display will show the TOTAL HOURS screen.

23. Push and hold down the PAUSE/STOP button and Down arrow button for about 5 seconds to go into the Engineering Mode.

24. Push the Down arrow button 12 times until the Console displays “ENTR MCB CLB”.

 **Be sure the area around the Treadmill is clear of all bystanders, children and pets. Be sure there is nothing on or under the Walking Belt, or near the Treadmill.**

25. The Console will display “MCB CALIB”.

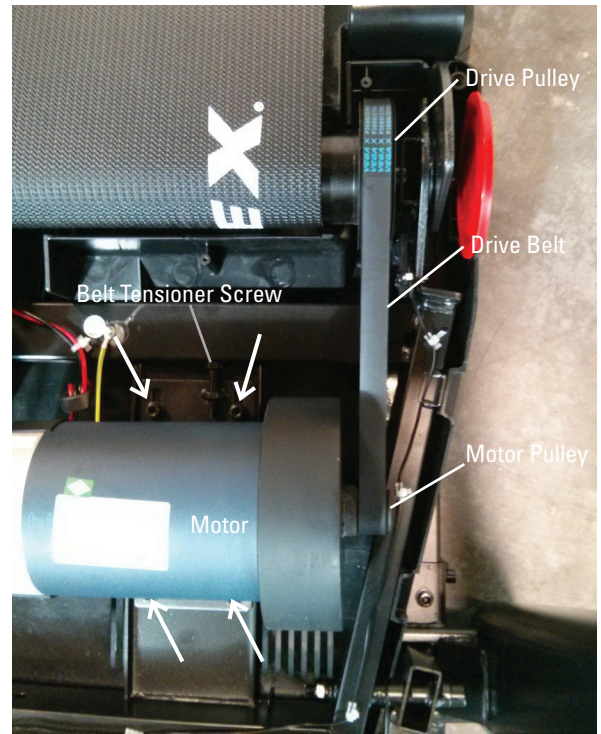

26. With the area clear, push the ENTER button. The calibration procedure will begin by automatically moving the Walking Belt.



**Be sure not to touch or allow anyone else to touch the machine while calibration is occurring.**

27. When calibration is complete, the Console will display "DONE".

28. Push the PAUSE/STOP button to exit the Engineering Mode.

29. Flip the power switch to OFF. Calibration is now complete for the machine.

30. Final Inspection

Inspect your machine to ensure that all hardware is tight and components are properly assembled.



**Do not use until the machine has been fully assembled and inspected for correct performance in accordance with the Owner's Manual.**

**NOTICE:** This document provides instructions for the replacement of the Motor Control Board (MCB) on the Bowflex™ BXT6 / BXT028 Treadmill.

If you need assistance, please contact Customer Service (if purchased in US/Canada) or your local distributor (if purchased outside US/Canada). To find your local distributor, go to: [www.nautilusinternational.com](http://www.nautilusinternational.com)

 **This icon means a potentially hazardous situation which, if not avoided, could result in death or serious injury. Read and understand all Warnings on this machine.**

Nautilus, Inc., [www.NautilusInc.com](http://www.NautilusInc.com), 5415 Centerpoint Parkway, Groveport, OH 43125 U.S.A. - Customer Service: North America (800) 605-3369, [csnls@nautilus.com](mailto:csnls@nautilus.com) | outside U.S. [www.nautilusinternational.com](http://www.nautilusinternational.com) | Printed in China | © 2018 Nautilus, Inc. | Bowflex and the B logo are trademarks owned or licensed by Nautilus, Inc., registered or otherwise protected by common law in the United States and other nations. | **ORIGINAL DOCUMENT - ENGLISH VERSION ONLY**

### Important Safety Instructions - Before servicing or using this equipment, obey the following warnings:

 **This icon means a potentially hazardous situation which, if not avoided, could result in death or serious injury. Read and understand all Warnings on this machine.**

**⚠ DANGER** To reduce the risk of electrical shock or unsupervised usage of the equipment, always unplug the power cord from the wall outlet and wait 5 minutes before cleaning, maintaining or repairing this machine. Place the power cord in a secure location.

- Read and understand the Part Replacement Procedure before working on the machine. Failure to obey the instructions and safety warnings could cause injury to the service technician or bystanders.
- Keep bystanders, children and pets away from the product being serviced at all times.
- Make sure that the repair is done in an appropriate work space away from foot traffic and exposure to bystanders.
- Disconnect all power and allow to sit for 5 minutes before you service this machine.
- Some components of the equipment can be heavy or awkward. Enlist the service of a second person when you do maintenance steps involving these components. Do not try to do heavy or awkward steps on your own.
- If replacement parts are necessary, use only genuine Nautilus replacement parts and hardware. Failure to use genuine replacement parts can cause a risk to users, keep the machine from operating correctly and will void the warranty.
- Be sure that all warning stickers and instructional placards applied to the product stay present and in good condition when doing maintenance or replacing components. If at any time the Warning labels become loose, unreadable or dislodged, replace the labels. If purchased in US/Canada, contact Customer Service for replacement labels. If purchased outside US/Canada, contact your local distributor for them.
- Do not try to change the design or functionality of the machine being serviced as this can adversely effect user safety and will void the warranty.
- Do not use the machine until all shrouds, instructions, warning labels and correct functionality have been verified and tested for correct performance.

### Tools Required (not included)

#2 Phillips screwdriver

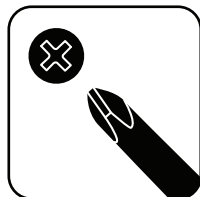



**⚠ DANGER** To reduce the risk of electrical shock or unsupervised usage of the equipment, always unplug the power cord from the wall outlet and wait 5 minutes before cleaning, maintaining or repairing this machine. Place the power cord in a secure location.

1. Unplug the power cord from the machine and wait 5 minutes. Place the power cord in a secure location.

2. Using a #2 Phillips screwdriver remove the 4 indicated screws, and two additional screws on the far side, from the Motor Cover and remove it.



3. Using a #2 Phillips screwdriver remove the 2 indicated screws from the MCB Cover and remove it.

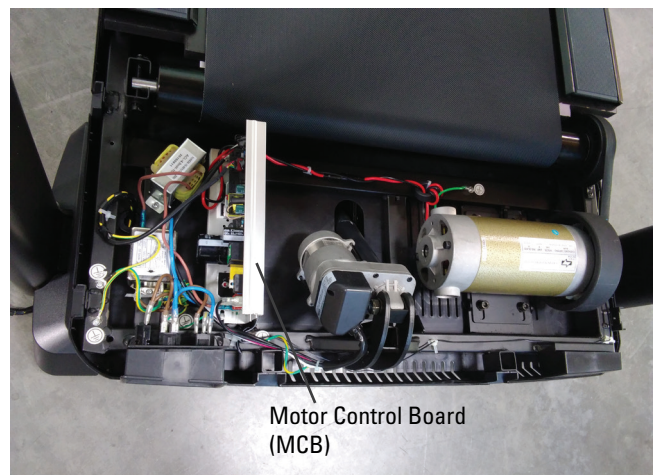
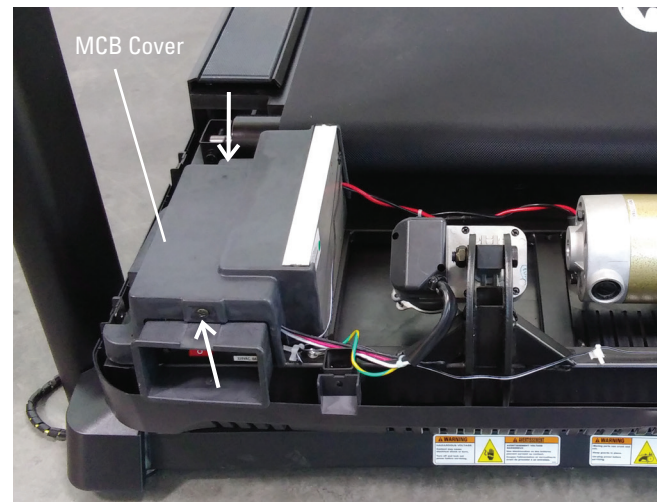

4. Remove the connectors from the Motor Control Board after noting their locations.

**Note:** Be sure to note where all cables attach for re-assembly.

5. Using a #2 Phillips screwdriver, remove the 2 indicated screws that attach the Motor Control Board (MCB) to the Frame.

6. Remove old Motor Control Board, and install the new Motor Control Board. Connect all the cables to the MCB in their proper locations. Be sure not to crimp any cables.

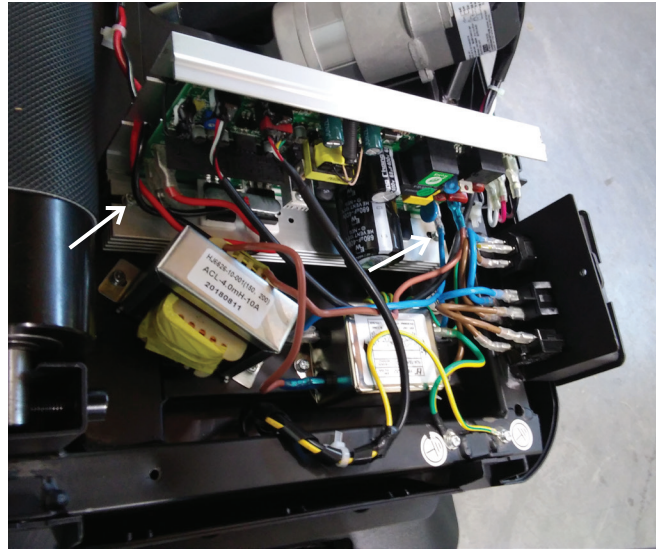

7. Re-install all remaining parts that were removed in reverse order.

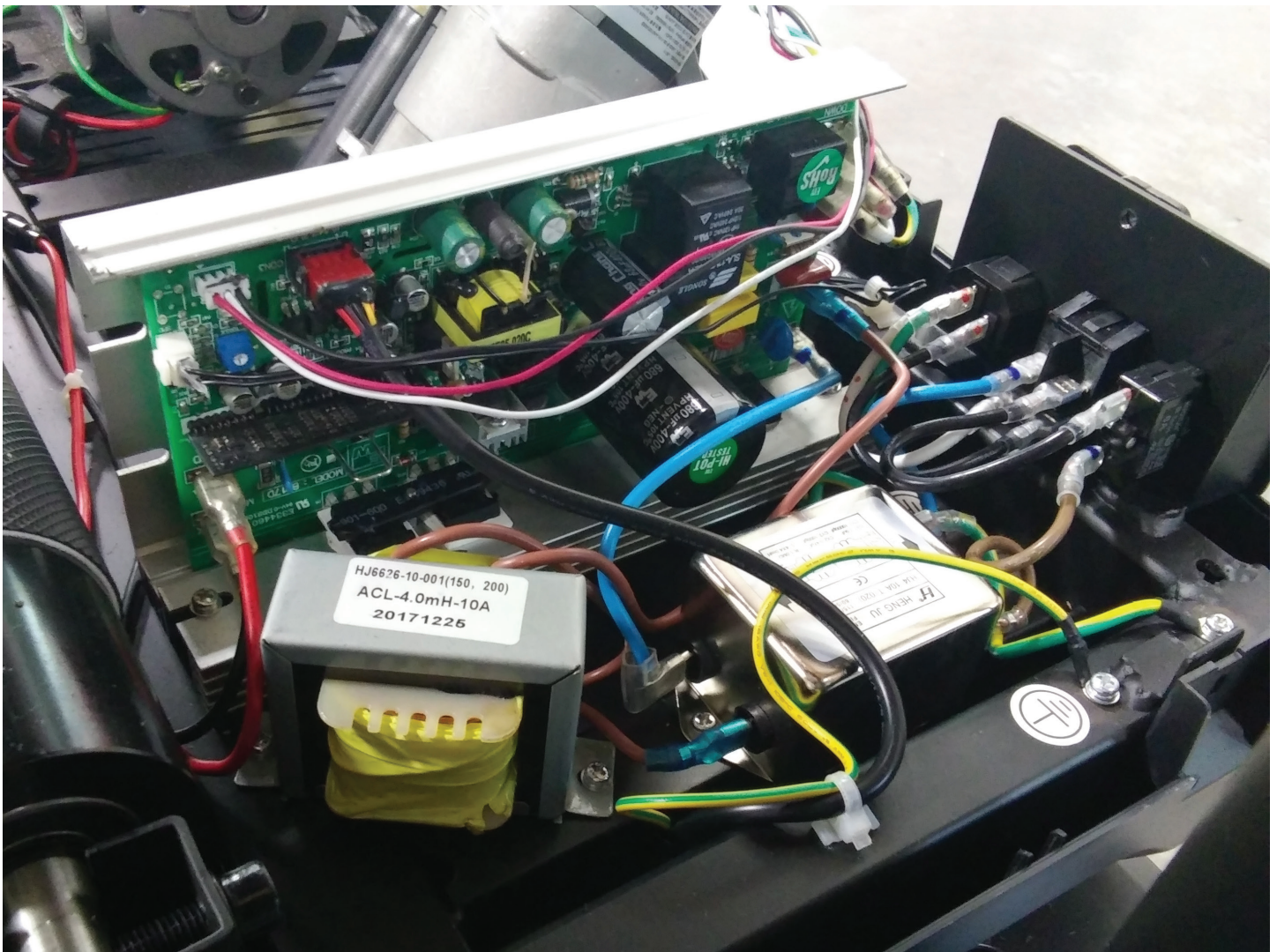

**Note:** The above photo shows the BXT028 machine, with Choke and Filter included.



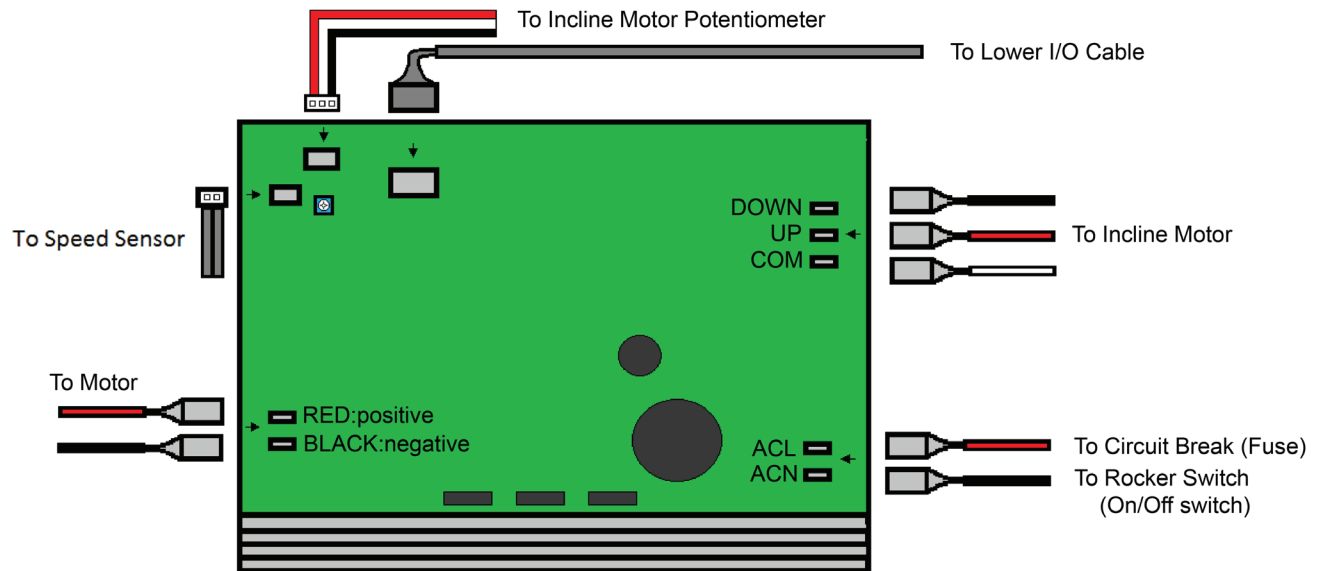

8. Attach the power cord and turn on the Treadmill by flipping the power switch to ON.

9. From the Power Up (or Welcome) screen, push and hold down the PAUSE/STOP button and Down arrow button for about 5 seconds to go into the Machine Setting Mode. The Console display will show the TOTAL HOURS screen.

10. Push and hold down the PAUSE/STOP button and Down arrow button for about 5 seconds to go into the Engineering Mode.

11. Push the Down arrow button 12 times until the Console displays "ENTR MCB CLB".

**⚠ Be sure the area around the Treadmill is clear of all bystanders, children and pets. Be sure there is nothing on or under the Walking Belt, or near the Treadmill.**

12. The Console will display "MCB CALIB".

13. With the area clear, push the ENTER button. The calibration procedure will begin by automatically moving the Walking Belt.

**⚠ Be sure not to touch or allow anyone else to touch the machine while calibration is occurring.**

14. When calibration is complete, the Console will display "DONE".

15. Push the PAUSE/STOP button to exit the Engineering Mode.

16. Flip the power switch to OFF. Calibration is now complete for the machine.

17. Final Inspection

Inspect your machine to ensure that all hardware is tight and components are properly assembled.

**⚠ Do not use until the machine has been fully assembled and inspected for correct performance in accordance with the Owner's Manual.**

**NOTICE:** This document provides instructions for the replacement of the Motor Control Board (MCB) Cover on the Bowflex™ BXT6 / BXT028 Treadmill.

If you need assistance, please contact Customer Service (if purchased in US/Canada) or your local distributor (if purchased outside US/Canada). To find your local distributor, go to: [www.nautilusinternational.com](http://www.nautilusinternational.com)

 **This icon means a potentially hazardous situation which, if not avoided, could result in death or serious injury. Read and understand all Warnings on this machine.**

Nautilus, Inc., [www.NautilusInc.com](http://www.NautilusInc.com), 5415 Centerpoint Parkway, Groveport, OH 43125 U.S.A. - Customer Service: North America (800) 605-3369, [csnls@nautilus.com](mailto:csnls@nautilus.com) | outside U.S. [www.nautilusinternational.com](http://www.nautilusinternational.com) | Printed in China | © 2020 Nautilus, Inc. | Bowflex and the B logo are trademarks owned or licensed by Nautilus, Inc., registered or otherwise protected by common law in the United States and other nations. | **ORIGINAL DOCUMENT - ENGLISH VERSION ONLY**

### Important Safety Instructions - Before servicing or using this equipment, obey the following warnings:

 **This icon means a potentially hazardous situation which, if not avoided, could result in death or serious injury. Read and understand all Warnings on this machine.**

**⚠ DANGER** To reduce the risk of electrical shock or unsupervised usage of the equipment, always unplug the power cord from the wall outlet and wait 5 minutes before cleaning, maintaining or repairing this machine. Place the power cord in a secure location.

- Read and understand the Part Replacement Procedure before working on the machine. Failure to obey the instructions and safety warnings could cause injury to the service technician or bystanders.
- Keep bystanders, children and pets away from the product being serviced at all times.
- Make sure that the repair is done in an appropriate work space away from foot traffic and exposure to bystanders.
- Disconnect all power and allow to sit for 5 minutes before you service this machine.
- Some components of the equipment can be heavy or awkward. Enlist the service of a second person when you do maintenance steps involving these components. Do not try to do heavy or awkward steps on your own.
- If replacement parts are necessary, use only genuine Nautilus replacement parts and hardware. Failure to use genuine replacement parts can cause a risk to users, keep the machine from operating correctly and will void the warranty.
- Be sure that all warning stickers and instructional placards applied to the product stay present and in good condition when doing maintenance or replacing components. If at any time the Warning labels become loose, unreadable or dislodged, replace the labels. If purchased in US/Canada, contact Customer Service for replacement labels. If purchased outside US/Canada, contact your local distributor for them.
- Do not try to change the design or functionality of the machine being serviced as this can adversely effect user safety and will void the warranty.
- Do not use the machine until all shrouds, instructions, warning labels and correct functionality have been verified and tested for correct performance.

### Tools Required (not included)

#2 Phillips screwdriver

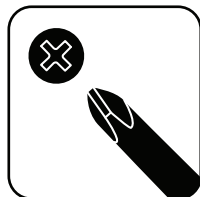

**⚠ DANGER** To reduce the risk of electrical shock or unsupervised usage of the equipment, always unplug the power cord from the wall outlet and wait 5 minutes before cleaning, maintaining or repairing this machine. Place the power cord in a secure location.

1. Unplug the power cord from the machine and wait 5 minutes. Place the power cord in a secure location.

2. Using a #2 Phillips screwdriver remove the 4 indicated screws, and two additional screws on the far side, from the Motor Cover and remove it.



3. Using a #2 Phillips screwdriver remove the 2 indicated screws from the Motor Control Board (MCB) Cover and remove it.

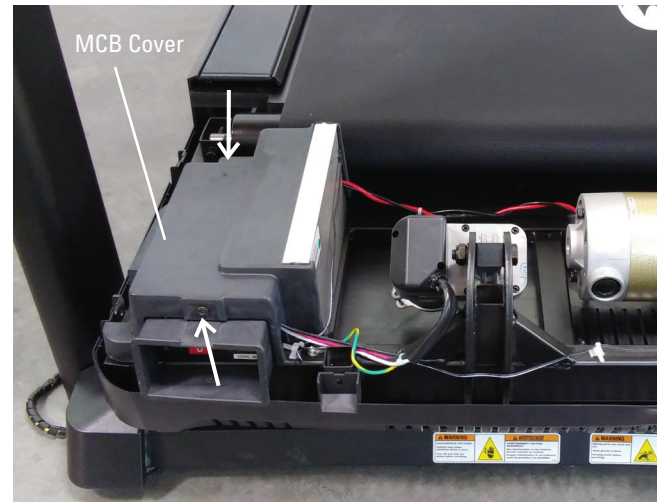

4. Re-install all remaining parts that were removed in reverse order.

5. Final Inspection  
Inspect your machine to ensure that all hardware is tight and components are properly assembled.

**⚠** Do not use until the machine has been fully assembled and inspected for correct performance in accordance with the Owner's Manual.

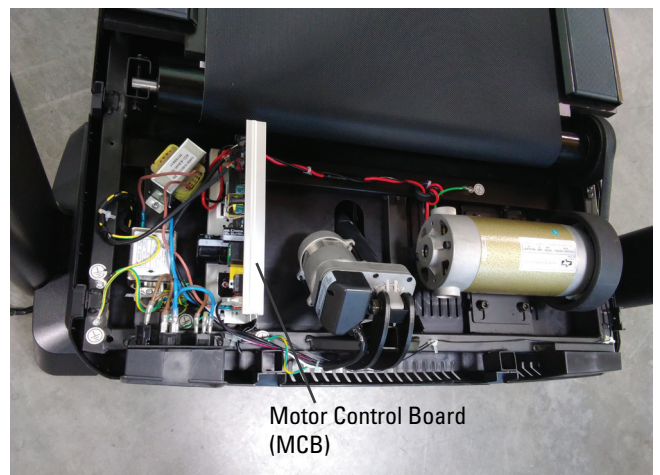

**NOTICE:** This document provides instructions for the replacement of the Motor Cover on the Bowflex™ BXT6 / BXT028 Treadmill.

If you need assistance, please contact Customer Service (if purchased in US/Canada) or your local distributor (if purchased outside US/Canada). To find your local distributor, go to: [www.nautilusinternational.com](http://www.nautilusinternational.com)

 **This icon means a potentially hazardous situation which, if not avoided, could result in death or serious injury. Read and understand all Warnings on this machine.**

Nautilus, Inc., [www.NautilusInc.com](http://www.NautilusInc.com), 5415 Centerpoint Parkway, Groveport, OH 43125 U.S.A. - Customer Service: North America (800) 605-3369, [csnls@nautilus.com](mailto:csnls@nautilus.com) | outside U.S. [www.nautilusinternational.com](http://www.nautilusinternational.com) | Printed in China | © 2020 Nautilus, Inc. | Bowflex and the B logo are trademarks owned or licensed by Nautilus, Inc., registered or otherwise protected by common law in the United States and other nations. | **ORIGINAL DOCUMENT - ENGLISH VERSION ONLY**

### Important Safety Instructions - Before servicing or using this equipment, obey the following warnings:

 **This icon means a potentially hazardous situation which, if not avoided, could result in death or serious injury. Read and understand all Warnings on this machine.**

**⚠ DANGER** To reduce the risk of electrical shock or unsupervised usage of the equipment, always unplug the power cord from the wall outlet and wait 5 minutes before cleaning, maintaining or repairing this machine. Place the power cord in a secure location.

- Read and understand the Part Replacement Procedure before working on the machine. Failure to obey the instructions and safety warnings could cause injury to the service technician or bystanders.
- Keep bystanders, children and pets away from the product being serviced at all times.
- Make sure that the repair is done in an appropriate work space away from foot traffic and exposure to bystanders.
- Disconnect all power and allow to sit for 5 minutes before you service this machine.
- Some components of the equipment can be heavy or awkward. Enlist the service of a second person when you do maintenance steps involving these components. Do not try to do heavy or awkward steps on your own.
- If replacement parts are necessary, use only genuine Nautilus replacement parts and hardware. Failure to use genuine replacement parts can cause a risk to users, keep the machine from operating correctly and will void the warranty.
- Be sure that all warning stickers and instructional placards applied to the product stay present and in good condition when doing maintenance or replacing components. If at any time the Warning labels become loose, unreadable or dislodged, replace the labels. If purchased in US/Canada, contact Customer Service for replacement labels. If purchased outside US/Canada, contact your local distributor for them.
- Do not try to change the design or functionality of the machine being serviced as this can adversely effect user safety and will void the warranty.
- Do not use the machine until all shrouds, instructions, warning labels and correct functionality have been verified and tested for correct performance.

### Tools Required (not included)

#2 Phillips screwdriver

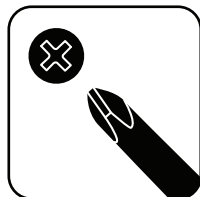

**⚠ DANGER** To reduce the risk of electrical shock or unsupervised usage of the equipment, always unplug the power cord from the wall outlet and wait 5 minutes before cleaning, maintaining or repairing this machine. Place the power cord in a secure location.

1. Unplug the power cord from the machine and wait 5 minutes. Place the power cord in a secure location.

2. Using a #2 Phillips screwdriver remove the 4 indicated screws, and two additional screws on the far side, from the Motor Cover and remove it.

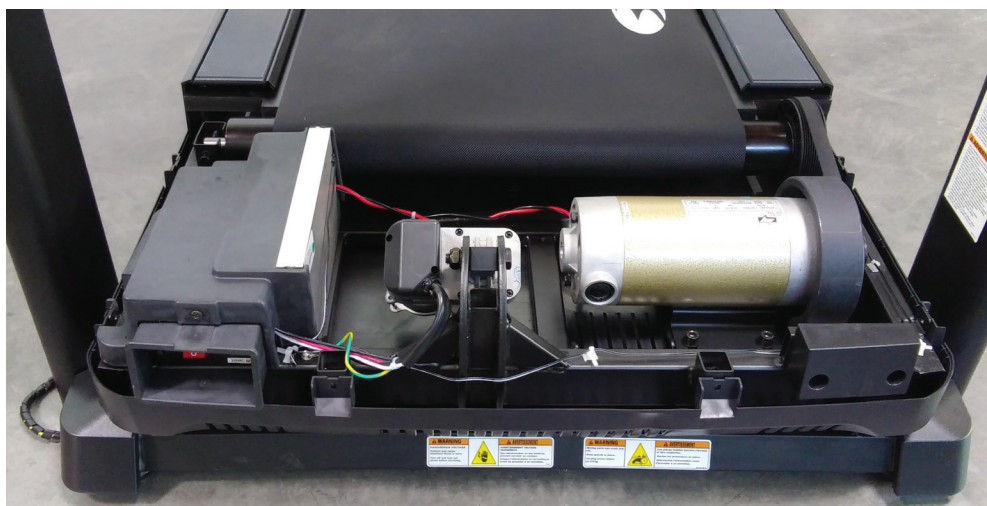

3. Re-install all remaining parts that were removed in reverse order.

#### 4. Final Inspection

Inspect your machine to ensure that all hardware is tight and components are properly assembled.

**⚠** Do not use until the machine has been fully assembled and inspected for correct performance in accordance with the Owner's Manual.



**NOTICE:** This document provides instructions for the replacement of the Motor Mount on the Bowflex™ BXT6 / BXT028 Treadmill.

If you need assistance, please contact Customer Service (if purchased in US/Canada) or your local distributor (if purchased outside US/Canada). To find your local distributor, go to: [www.nautilusinternational.com](http://www.nautilusinternational.com)

**This icon means a potentially hazardous situation which, if not avoided, could result in death or serious injury. Read and understand all Warnings on this machine.**

Nautilus, Inc., [www.NautilusInc.com](http://www.NautilusInc.com), 5415 Centerpoint Parkway, Groveport, OH 43125 U.S.A. - Customer Service: North America (800) 605-3369, [csnls@nautilus.com](mailto:csnls@nautilus.com) | outside U.S. [www.nautilusinternational.com](http://www.nautilusinternational.com) | Printed in China | © 2020 Nautilus, Inc. | Bowflex and the B logo are trademarks owned or licensed by Nautilus, Inc., registered or otherwise protected by common law in the United States and other nations. | **ORIGINAL DOCUMENT - ENGLISH VERSION ONLY**

### Important Safety Instructions - Before servicing or using this equipment, obey the following warnings:

**This icon means a potentially hazardous situation which, if not avoided, could result in death or serious injury. Read and understand all Warnings on this machine.**

**⚠ DANGER** To reduce the risk of electrical shock or unsupervised usage of the equipment, always unplug the power cord from the wall outlet and wait 5 minutes before cleaning, maintaining or repairing this machine. Place the power cord in a secure location.

- Read and understand the Part Replacement Procedure before working on the machine. Failure to obey the instructions and safety warnings could cause injury to the service technician or bystanders.
- Keep bystanders, children and pets away from the product being serviced at all times.
- Make sure that the repair is done in an appropriate work space away from foot traffic and exposure to bystanders.
- Disconnect all power and allow to sit for 5 minutes before you service this machine.
- Some components of the equipment can be heavy or awkward. Enlist the service of a second person when you do maintenance steps involving these components. Do not try to do heavy or awkward steps on your own.
- If replacement parts are necessary, use only genuine Nautilus replacement parts and hardware. Failure to use genuine replacement parts can cause a risk to users, keep the machine from operating correctly and will void the warranty.
- Be sure that all warning stickers and instructional placards applied to the product stay present and in good condition when doing maintenance or replacing components. If at any time the Warning labels become loose, unreadable or dislodged, replace the labels. If purchased in US/Canada, contact Customer Service for replacement labels. If purchased outside US/Canada, contact your local distributor for them.
- Do not try to change the design or functionality of the machine being serviced as this can adversely effect user safety and will void the warranty.
- Do not use the machine until all shrouds, instructions, warning labels and correct functionality have been verified and tested for correct performance.

#### Tools Required (not included)

#2 Phillips screwdriver

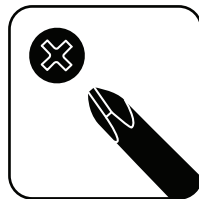

6mm Hex Wrench



13mm Wrench





**⚠ DANGER** To reduce the risk of electrical shock or unsupervised usage of the equipment, always unplug the power cord from the wall outlet and wait 5 minutes before cleaning, maintaining or repairing this machine. Place the power cord in a secure location.

1. Unplug the power cord from the machine and wait 5 minutes. Place the power cord in a secure location.

2. Using a #2 Phillips screwdriver remove the 4 indicated screws, and two additional screws on the far side, from the Motor Cover and remove it.



3. Using a 6mm hex wrench, loosen the indicated screws (by arrows) on the Motor Mount.

4. Using a 13mm Open Ended Wrench, rotate the Belt Tensioner Screw enough to loosen the Drive Belt.

**Note:** To assist with reassembly, be sure to record the number of threads exposed before loosening.

5. Using a 6mm hex wrench, remove the indicated screws from the Motor Mount. Remove the Drive Belt and rotate the Motor Assembly exposing the Motor Mount.

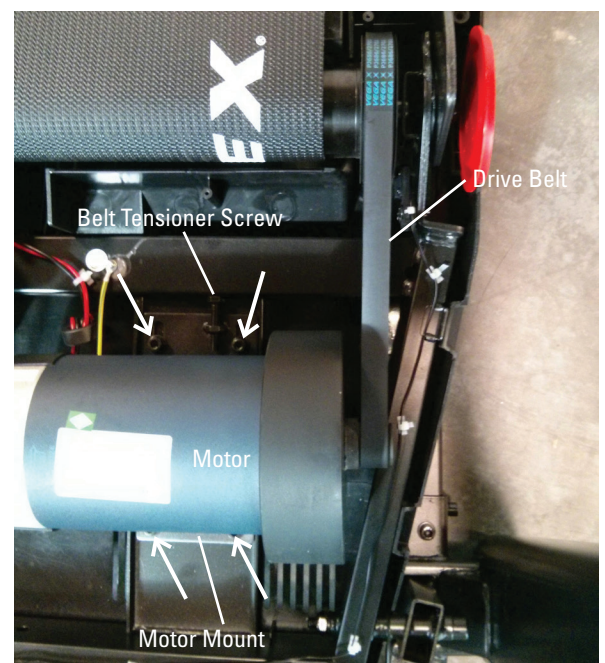

6. Using a 6mm hex wrench, remove the indicated hardware from the Motor Mount.

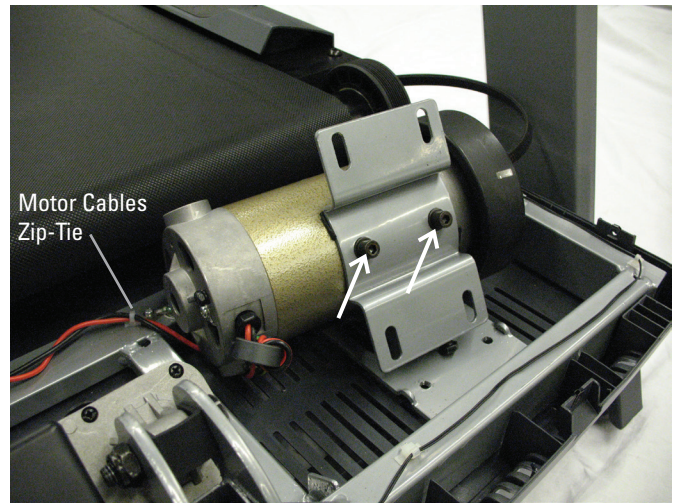

7. Attach the new Motor Mount to the Motor. Be sure the Belt Tensioner Screw is properly oriented toward the rear of the machine when the Motor is re-installed.

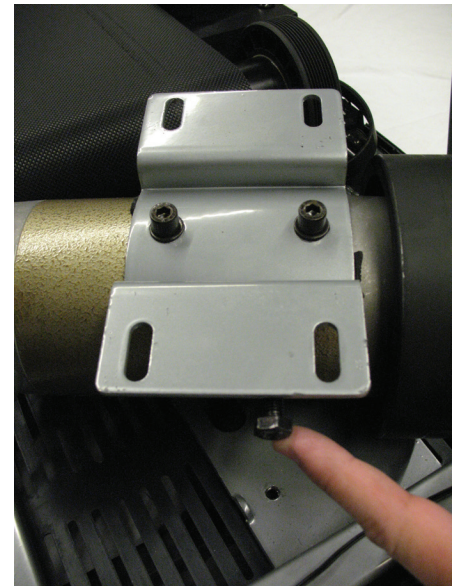

8. Lightly attach the Motor Assembly to the Frame. Be sure to only finger tighten the hardware.

9. Loop the Drive Belt onto the Motor Pulley. With the Drive Belt looped onto the Motor, carefully roll the Drive Belt onto the Drive Pulley in a clockwise motion. Be sure the Belt does not come off of the Motor Pulley.

**⚠ Keep fingers out of any pinch opportunities when turning the Pulleys.**

10. Roll the Drive Pulley clockwise until the Drive Belt is fully installed. Continue to roll the Belt forward while adding side pressure with fingers to align as necessary.

11. With the Motor Assembly loosely attached to the Frame, turn the Belt Tensioner Screw to the previous level. This will tighten the Drive Belt to the previous tension level.

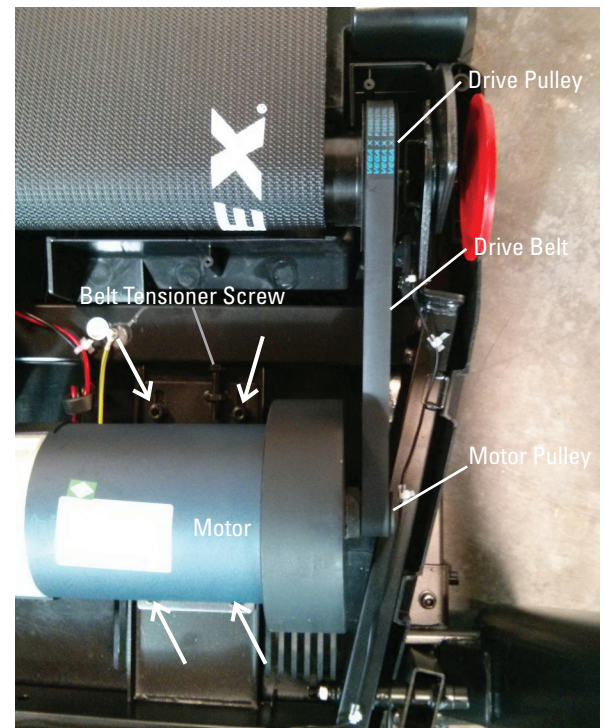

12. Using a 6mm hex wrench, fully tighten the screws that attach the Motor Assembly to the Frame.

13. Re-install all remaining parts that were removed in reverse order.

14. Attach the power cord and turn on the Treadmill by flipping the power switch to ON.

15. From the Power Up (or Welcome) screen, push and hold down the PAUSE/STOP button and Down arrow button for about 5 seconds to go into the Machine Setting Mode. The Console display will show the TOTAL HOURS screen.

16. Push and hold down the PAUSE/STOP button and Down arrow button for about 5 seconds to go into the Engineering Mode.

17. Push the Down arrow button 12 times until the Console displays "ENTR MCB CLB".



**Be sure the area around the Treadmill is clear of all bystanders, children and pets. Be sure there is nothing on or under the Walking Belt, or near the Treadmill.**

18. The Console will display "MCB CALIB".

19. With the area clear, push the ENTER button. The calibration procedure will begin by automatically moving the Walking Belt.



**Be sure not to touch or allow anyone else to touch the machine while calibration is occurring.**

20. When calibration is complete, the Console will display "DONE".

21. Push the PAUSE/STOP button to exit the Engineering Mode.

22. Flip the power switch to OFF. Calibration is now complete for the machine.

23. Final Inspection

Inspect your machine to ensure that all hardware is tight and components are properly assembled.



**Do not use until the machine has been fully assembled and inspected for correct performance in accordance with the Owner's Manual.**

**NOTICE:** This document provides instructions for the replacement of the Power Inlet on the Bowflex™ BXT6 / BXT028 Treadmill.

If you need assistance, please contact Customer Service (if purchased in US/Canada) or your local distributor (if purchased outside US/Canada). To find your local distributor, go to: [www.nautilusinternational.com](http://www.nautilusinternational.com)

 **This icon means a potentially hazardous situation which, if not avoided, could result in death or serious injury. Read and understand all Warnings on this machine.**

Nautilus, Inc., [www.NautilusInc.com](http://www.NautilusInc.com), 5415 Centerpoint Parkway, Groveport, OH 43125 U.S.A. - Customer Service: North America (800) 605-3369, [csnls@nautilus.com](mailto:csnls@nautilus.com) | outside U.S. [www.nautilusinternational.com](http://www.nautilusinternational.com) | Printed in China | © 2020 Nautilus, Inc. | Bowflex and the B logo are trademarks owned or licensed by Nautilus, Inc., registered or otherwise protected by common law in the United States and other nations. | **ORIGINAL DOCUMENT - ENGLISH VERSION ONLY**

### Important Safety Instructions - Before servicing or using this equipment, obey the following warnings:

 **This icon means a potentially hazardous situation which, if not avoided, could result in death or serious injury. Read and understand all Warnings on this machine.**

**DANGER** To reduce the risk of electrical shock or unsupervised usage of the equipment, always unplug the power cord from the wall outlet and wait 5 minutes before cleaning, maintaining or repairing this machine. Place the power cord in a secure location.

- Read and understand the Part Replacement Procedure before working on the machine. Failure to obey the instructions and safety warnings could cause injury to the service technician or bystanders.
- Keep bystanders, children and pets away from the product being serviced at all times.
- Make sure that the repair is done in an appropriate work space away from foot traffic and exposure to bystanders.
- Disconnect all power and allow to sit for 5 minutes before you service this machine.
- Some components of the equipment can be heavy or awkward. Enlist the service of a second person when you do maintenance steps involving these components. Do not try to do heavy or awkward steps on your own.
- If replacement parts are necessary, use only genuine Nautilus replacement parts and hardware. Failure to use genuine replacement parts can cause a risk to users, keep the machine from operating correctly and will void the warranty.
- Be sure that all warning stickers and instructional placards applied to the product stay present and in good condition when doing maintenance or replacing components. If at any time the Warning labels become loose, unreadable or dislodged, replace the labels. If purchased in US/Canada, contact Customer Service for replacement labels. If purchased outside US/Canada, contact your local distributor for them.
- Do not try to change the design or functionality of the machine being serviced as this can adversely effect user safety and will void the warranty.
- Do not use the machine until all shrouds, instructions, warning labels and correct functionality have been verified and tested for correct performance.

### Tools Required (not included)

#2 Phillips screwdriver

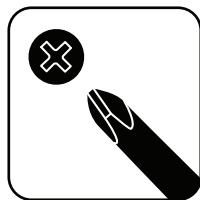



**⚠ DANGER** To reduce the risk of electrical shock or unsupervised usage of the equipment, always unplug the power cord from the wall outlet and wait 5 minutes before cleaning, maintaining or repairing this machine. Place the power cord in a secure location.

1. Unplug the power cord from the machine and wait 5 minutes. Place the power cord in a secure location.

2. Using a #2 Phillips screwdriver remove the 4 indicated screws, and two additional screws on the far side, from the Motor Cover and remove it.



3. Using a #2 Phillips screwdriver remove the 2 indicated screws from the MCB Cover and remove it.

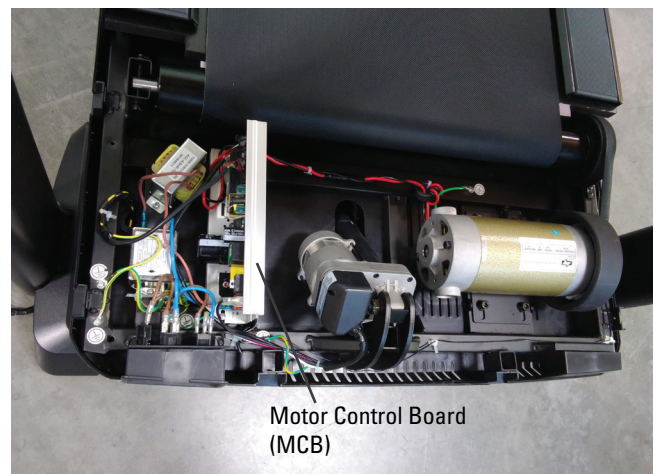
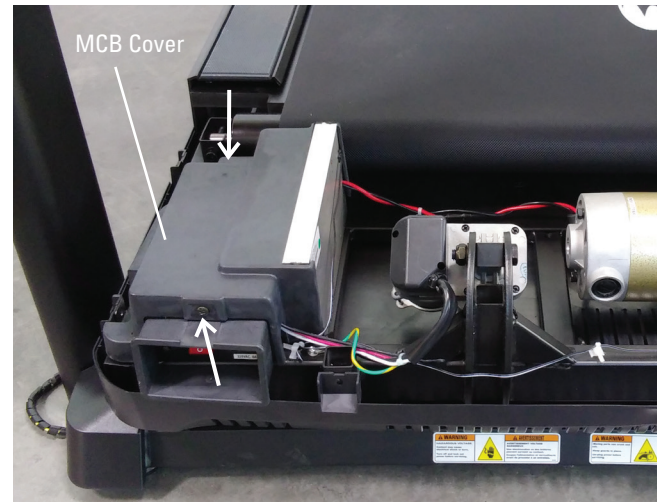



4. Release the Securing Clips from the Power Inlet and remove it from the Frame.

5. Remove the connectors and attach them to the new Power Inlet. Be sure to attach them in the same locations on the new Power Inlet.

6. Insert the new Power Inlet into the Frame being sure the Securing Clips engage.

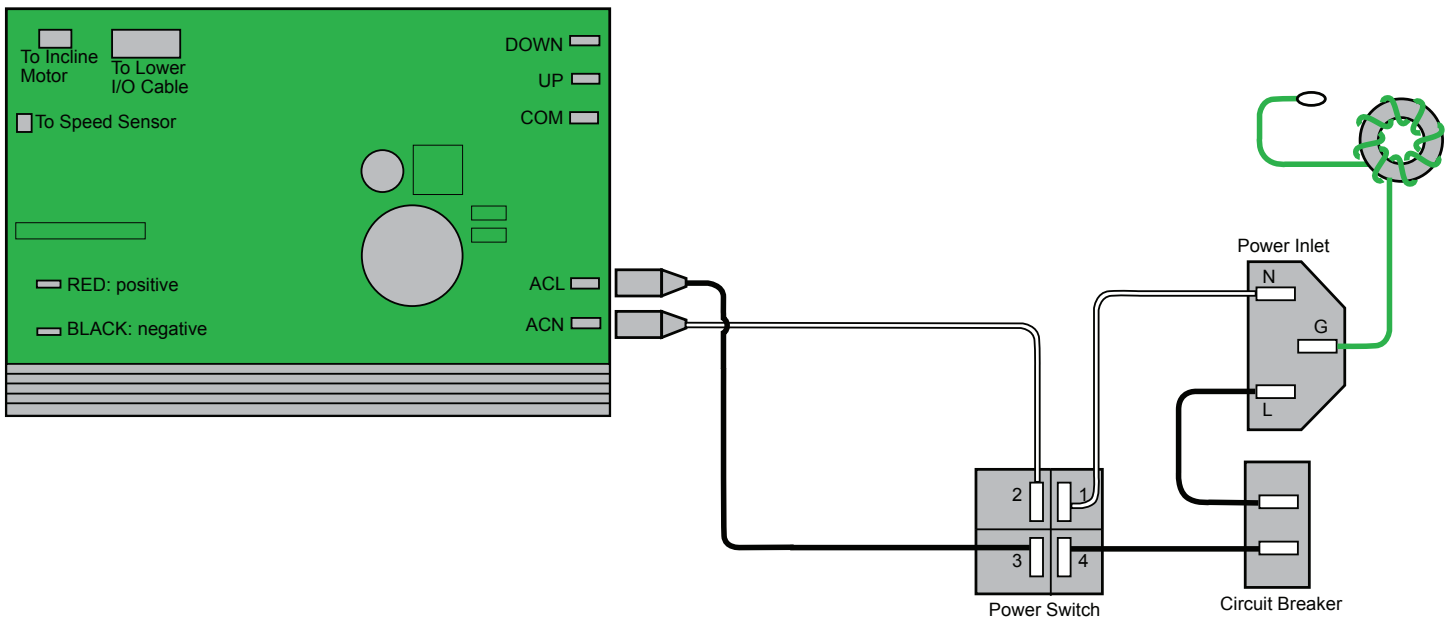
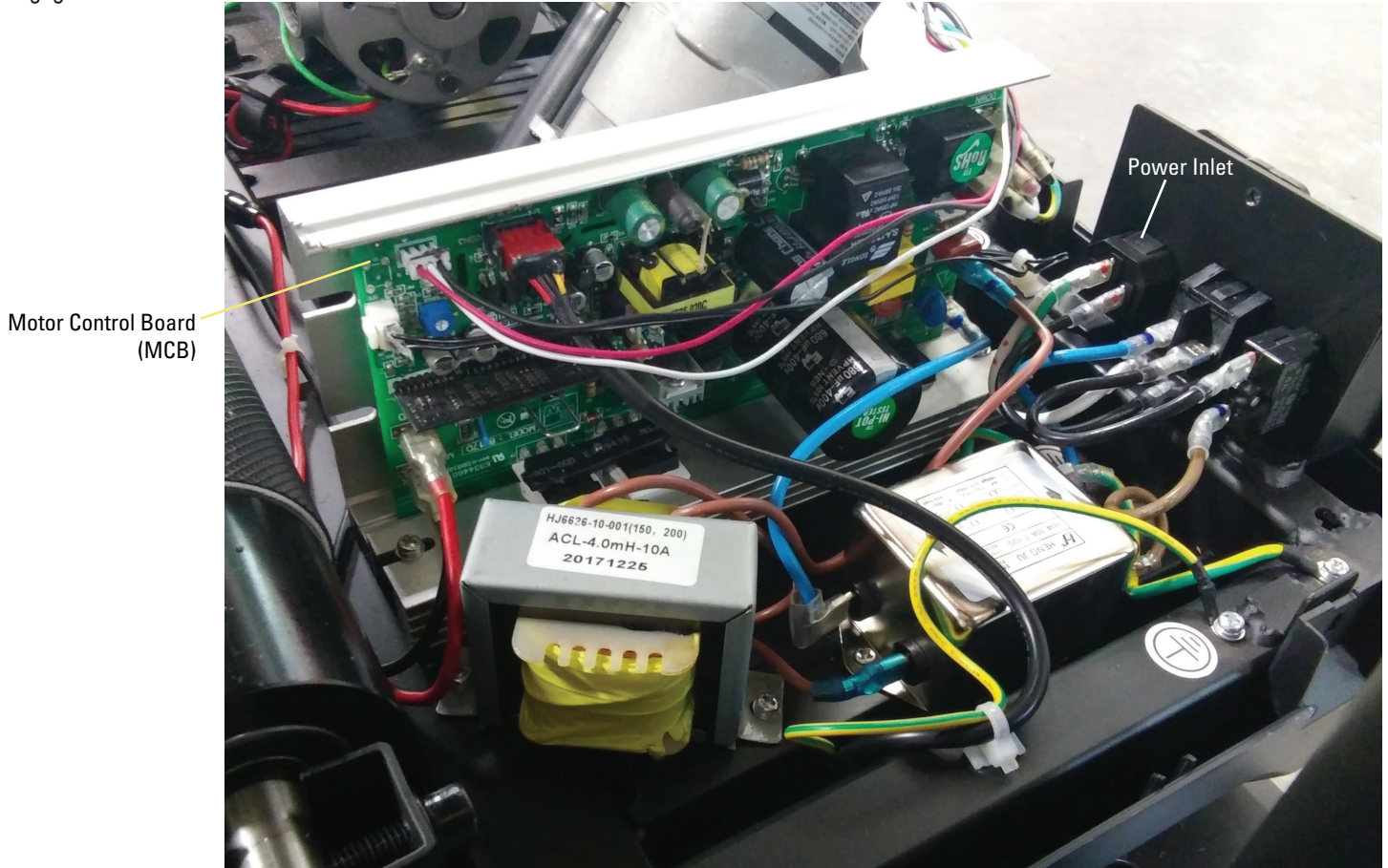

7. Re-install all remaining parts that were removed in reverse order.

8. Final Inspection

Inspect your machine to ensure that all hardware is tight and components are properly assembled.



**Do not use until the machine has been fully assembled and inspected for correct performance in accordance with the Owner's Manual.**

**NOTICE:** This document provides instructions for the replacement of the Rear Roller on the Bowflex™ BXT6 / BXT028 Treadmill.

If you need assistance, please contact Customer Service (if purchased in US/Canada) or your local distributor (if purchased outside US/Canada). To find your local distributor, go to: [www.nautilusinternational.com](http://www.nautilusinternational.com)

 **This icon means a potentially hazardous situation which, if not avoided, could result in death or serious injury. Read and understand all Warnings on this machine.**

Nautilus, Inc., [www.NautilusInc.com](http://www.NautilusInc.com), 5415 Centerpoint Parkway, Groveport, OH 43125 U.S.A. - Customer Service: North America (800) 605-3369, [csnls@nautilus.com](mailto:csnls@nautilus.com) | outside U.S. [www.nautilusinternational.com](http://www.nautilusinternational.com) | Printed in China | © 2020 Nautilus, Inc. | Bowflex and the B logo are trademarks owned or licensed by Nautilus, Inc., registered or otherwise protected by common law in the United States and other nations. | **ORIGINAL DOCUMENT - ENGLISH VERSION ONLY**

### Important Safety Instructions - Before servicing or using this equipment, obey the following warnings:

 **This icon means a potentially hazardous situation which, if not avoided, could result in death or serious injury. Read and understand all Warnings on this machine.**

**⚠ DANGER** To reduce the risk of electrical shock or unsupervised usage of the equipment, always unplug the power cord from the wall outlet and wait 5 minutes before cleaning, maintaining or repairing this machine. Place the power cord in a secure location.

- Read and understand the Part Replacement Procedure before working on the machine. Failure to obey the instructions and safety warnings could cause injury to the service technician or bystanders.
- Keep bystanders, children and pets away from the product being serviced at all times.
- Make sure that the repair is done in an appropriate work space away from foot traffic and exposure to bystanders.
- Disconnect all power and allow to sit for 5 minutes before you service this machine.
- Some components of the equipment can be heavy or awkward. Enlist the service of a second person when you do maintenance steps involving these components. Do not try to do heavy or awkward steps on your own.
- If replacement parts are necessary, use only genuine Nautilus replacement parts and hardware. Failure to use genuine replacement parts can cause a risk to users, keep the machine from operating correctly and will void the warranty.
- Be sure that all warning stickers and instructional placards applied to the product stay present and in good condition when doing maintenance or replacing components. If at any time the Warning labels become loose, unreadable or dislodged, replace the labels. If purchased in US/Canada, contact Customer Service for replacement labels. If purchased outside US/Canada, contact your local distributor for them.
- Do not try to change the design or functionality of the machine being serviced as this can adversely effect user safety and will void the warranty.
- Do not use the machine until all shrouds, instructions, warning labels and correct functionality have been verified and tested for correct performance.

#### Tools Required (not included)

#2 Phillips screwdriver

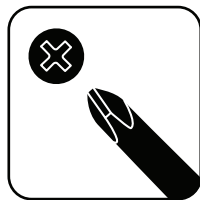

6mm Hex Wrench



**⚠ DANGER** To reduce the risk of electrical shock or unsupervised usage of the equipment, always unplug the power cord from the wall outlet and wait 5 minutes before cleaning, maintaining or repairing this machine. Place the power cord in a secure location.

1. Unplug the power cord from the machine and wait 5 minutes. Place the power cord in a secure location.

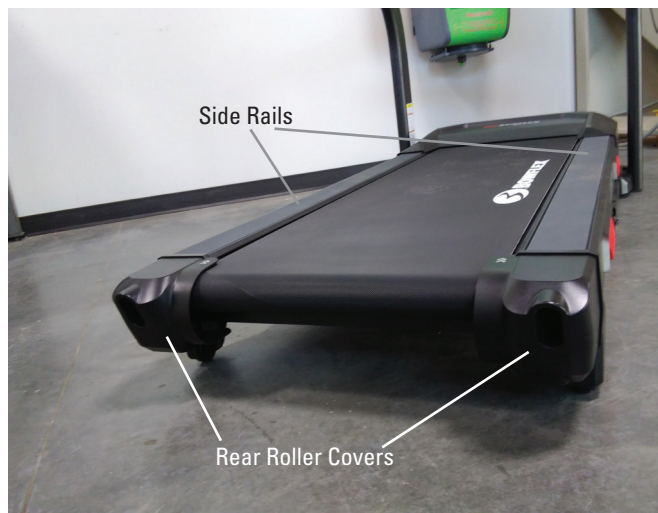

2. Using a #2 Phillips screwdriver, remove the indicated screw (with arrow) from each of the Rear Roller Covers.



3. Make sure that there is safe clearance around, on and above the treadmill. Make sure there is no object to spill or cause blockage from the fully folded position.

**⚠** Be sure there is adequate height clearance for the raised deck.

4. Using the support bar found below the rear of the walking belt, lift the walking deck fully upward and engage the hydraulic lift. Be sure that the hydraulic lift is correctly locked in place. You will hear an audible click when the hydraulic lift shifts into the locked position.

**⚠** Use proper safety precautions and lifting techniques. Bend your knees and elbows, keep your back straight and pull up equally with both arms. Make sure that your own physical strength is capable of lifting the walking deck until it engages the locking mechanism. Use a second person if necessary.

Do not use the walking belt or rear roller to lift the treadmill. These parts do not lock in place and can abruptly move. Injury to you or damage to the machine can occur.

5. Make sure that the locking mechanism is engaged. Carefully pull back on the walking deck and make sure that it does not move. When you do this, keep clear of movement path in case the treadmill lock is not properly engaged.

**⚠** Do not lean against the treadmill when it is folded. Do not put items on it that could cause it to become unstable or fall.

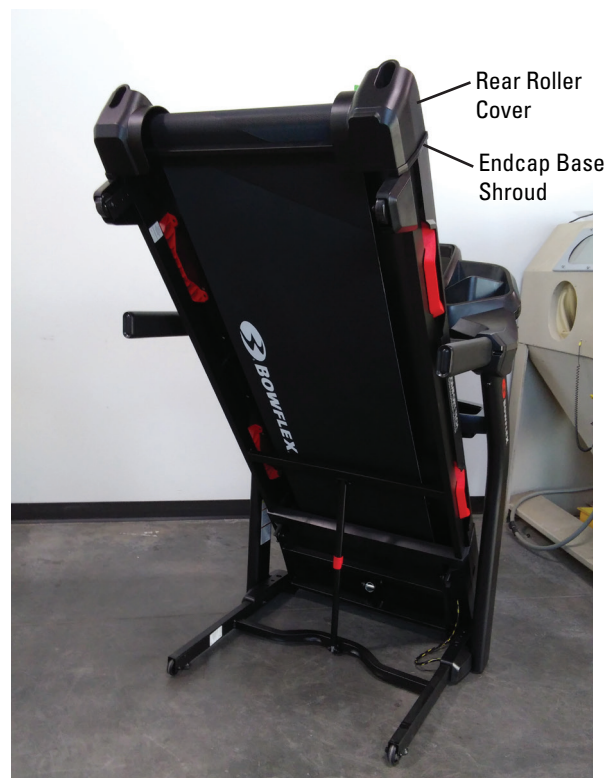



6. Using a #2 Phillips screwdriver, remove the indicated screw (with arrow) from each the Rear Roller Covers.

7. Remove the Rear Roller Covers and Endcap Base Shrouds.

**Note:** To assist with reassembly, be sure to notice how the Endcap Base Shroud is secured by the Rear Roller Cover.

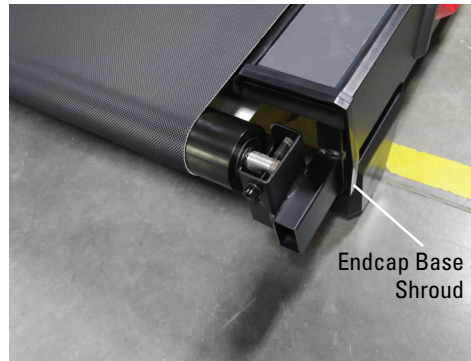

8. Using a #2 Phillips screwdriver, remove the 12 indicated screws from below the Walking Deck that attach the Side Rails.

9. Remove the Side Rails from the Walking Decks.





10. Make sure there is sufficient space to lower the walking deck.

**!** Keep a minimum clearance behind the machine of 79" (2 m) and 24" (0.6 m) on each side. This is the recommended safe distance for access, movement and emergency dismounts from the machine.

11. Make sure there is no object on or around the treadmill to spill or cause blockage from the fully unfolded position.

12. Slightly push the walking deck forward toward the console. With your foot lightly push the top part of the hydraulic lift forward until the locking tube releases and you can pull the walking deck away from the console. Hold up the rear of the walking deck, and move to the side of the machine.

**!** Keep clear of the movement path of the walking deck.

13. The hydraulic lift is set up to drop gradually. Hold onto the walking deck until approximately 2/3 of the movement down. Lower the weight with your legs. Be aware that the walking deck can possibly drop quickly in the last part of the movement.



14. Using a 6mm hex wrench, finish removing both of the Adjustment Bolts from the Rear Roller.

**Note:** Be sure to record the number of turns of the Adjustment Bolt it takes to remove it. This will assist with reassembly.

15. Slide the Rear Roller out of the Walking Belt.

16. Slide the new Rear Roller into the new Walking Belt in the same orientation.

17. Using a 6mm hex wrench, re-attach the Adjustment Bolt to the Rear Roller.

**Note:** Be sure to tighten the Adjustment Bolt the same number of turns it took to loosen the Walking Belt.

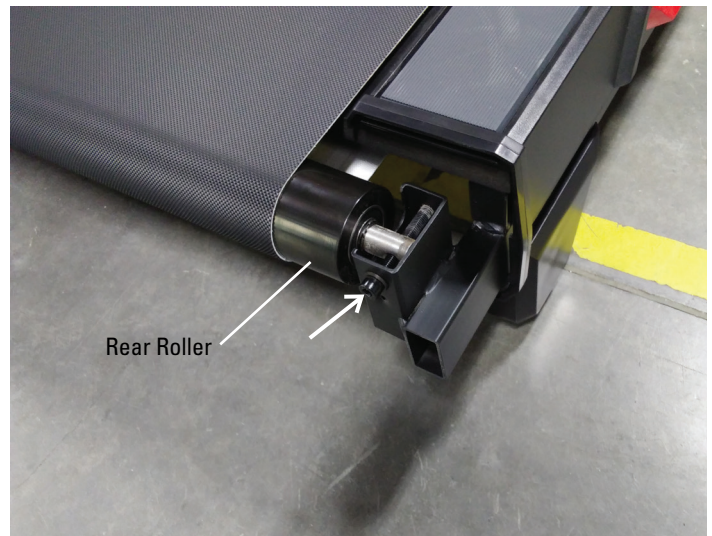

18. Re-install all remaining parts that were removed in reverse order.

19. Final Inspection

Inspect your machine to ensure that all hardware is tight and components are properly assembled.

**!** Do not use until the machine has been fully assembled and inspected for correct performance in accordance with the Owner's Manual.

**NOTICE:** This document provides instructions for the replacement of the Rear Roller Cover on the Bowflex™ BXT6 / BXT028 Treadmill.

If you need assistance, please contact Customer Service (if purchased in US/Canada) or your local distributor (if purchased outside US/Canada). To find your local distributor, go to: [www.nautilusinternational.com](http://www.nautilusinternational.com)

 **This icon means a potentially hazardous situation which, if not avoided, could result in death or serious injury. Read and understand all Warnings on this machine.**

Nautilus, Inc., [www.NautilusInc.com](http://www.NautilusInc.com), 5415 Centerpoint Parkway, Groveport, OH 43125 U.S.A. - Customer Service: North America (800) 605-3369, [csnls@nautilus.com](mailto:csnls@nautilus.com) | outside U.S. [www.nautilusinternational.com](http://www.nautilusinternational.com) | Printed in China | © 2020 Nautilus, Inc. | Bowflex and the B logo are trademarks owned or licensed by Nautilus, Inc., registered or otherwise protected by common law in the United States and other nations. | **ORIGINAL DOCUMENT - ENGLISH VERSION ONLY**

### Important Safety Instructions - Before servicing or using this equipment, obey the following warnings:

 **This icon means a potentially hazardous situation which, if not avoided, could result in death or serious injury. Read and understand all Warnings on this machine.**

**⚠ DANGER** To reduce the risk of electrical shock or unsupervised usage of the equipment, always unplug the power cord from the wall outlet and wait 5 minutes before cleaning, maintaining or repairing this machine. Place the power cord in a secure location.

- Read and understand the Part Replacement Procedure before working on the machine. Failure to obey the instructions and safety warnings could cause injury to the service technician or bystanders.
- Keep bystanders, children and pets away from the product being serviced at all times.
- Make sure that the repair is done in an appropriate work space away from foot traffic and exposure to bystanders.
- Disconnect all power and allow to sit for 5 minutes before you service this machine.
- Some components of the equipment can be heavy or awkward. Enlist the service of a second person when you do maintenance steps involving these components. Do not try to do heavy or awkward steps on your own.
- If replacement parts are necessary, use only genuine Nautilus replacement parts and hardware. Failure to use genuine replacement parts can cause a risk to users, keep the machine from operating correctly and will void the warranty.
- Be sure that all warning stickers and instructional placards applied to the product stay present and in good condition when doing maintenance or replacing components. If at any time the Warning labels become loose, unreadable or dislodged, replace the labels. If purchased in US/Canada, contact Customer Service for replacement labels. If purchased outside US/Canada, contact your local distributor for them.
- Do not try to change the design or functionality of the machine being serviced as this can adversely effect user safety and will void the warranty.
- Do not use the machine until all shrouds, instructions, warning labels and correct functionality have been verified and tested for correct performance.

#### Tools Required (not included)

#2 Phillips screwdriver



**⚠ DANGER** To reduce the risk of electrical shock or unsupervised usage of the equipment, always unplug the power cord from the wall outlet and wait 5 minutes before cleaning, maintaining or repairing this machine. Place the power cord in a secure location.

1. Unplug the power cord from the machine and wait 5 minutes. Place the power cord in a secure location.

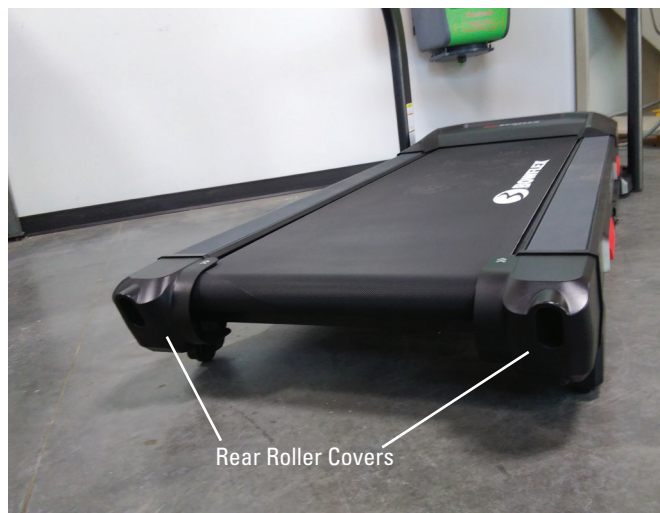

2. Using a #2 Phillips screwdriver, remove the indicated screw (with arrow) from each of the Rear Roller Covers.

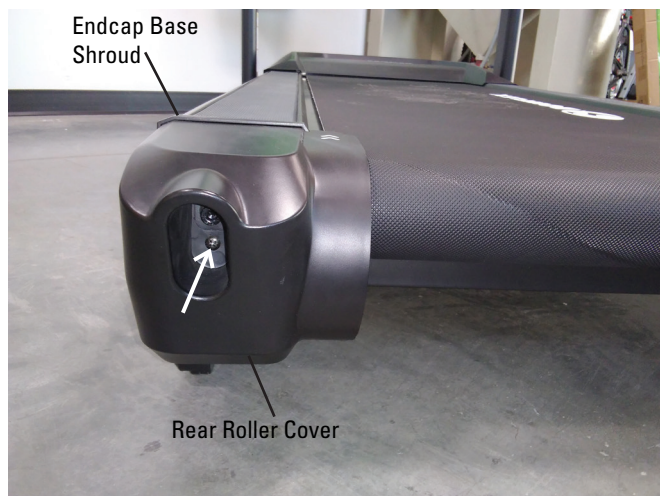

**Note:** Though the following image shows the Walking Deck raised, it is not necessary to complete the next steps.

3. Using a #2 Phillips screwdriver, remove the indicated screw (with arrow) from each of the Rear Roller Covers.

4. Remove the old Rear Roller Covers, and attach the new Rear Roller Covers.

**Note:** To assist with reassembly, be sure to notice how the Endcap Base Shroud is secured by the Rear Roller Cover.

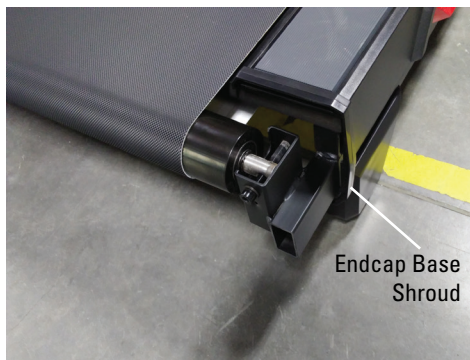

5. Re-install all remaining parts that were removed in reverse order.

6. Final Inspection

Inspect your machine to ensure that all hardware is tight and components are properly assembled.



**Do not use until the machine has been fully assembled and inspected for correct performance in accordance with the Owner's Manual.**



**NOTICE:** This document provides instructions for the replacement of the Right Upright on the Bowflex™ BXT6 / BXT028 Treadmill.

If you need assistance, please contact Customer Service (if purchased in US/Canada) or your local distributor (if purchased outside US/Canada). To find your local distributor, go to: [www.nautilusinternational.com](http://www.nautilusinternational.com)

 This icon means a potentially hazardous situation which, if not avoided, could result in death or serious injury. Read and understand all Warnings on this machine.

Nautilus, Inc., [www.NautilusInc.com](http://www.NautilusInc.com), 5415 Centerpoint Parkway, Groveport, OH 43125 U.S.A. - Customer Service: North America (800) 605-3369, [csnls@nautilus.com](mailto:csnls@nautilus.com) | outside U.S. [www.nautilusinternational.com](http://www.nautilusinternational.com) | Printed in China | © 2020 Nautilus, Inc. | Bowflex and the B logo are trademarks owned or licensed by Nautilus, Inc., registered or otherwise protected by common law in the United States and other nations. | **ORIGINAL DOCUMENT - ENGLISH VERSION ONLY**

### Important Safety Instructions - Before servicing or using this equipment, obey the following warnings:

 This icon means a potentially hazardous situation which, if not avoided, could result in death or serious injury. Read and understand all Warnings on this machine.

**⚠ DANGER** To reduce the risk of electrical shock or unsupervised usage of the equipment, always unplug the power cord from the wall outlet and wait 5 minutes before cleaning, maintaining or repairing this machine. Place the power cord in a secure location.

- Read and understand the Part Replacement Procedure before working on the machine. Failure to obey the instructions and safety warnings could cause injury to the service technician or bystanders.
- Keep bystanders, children and pets away from the product being serviced at all times.
- Make sure that the repair is done in an appropriate work space away from foot traffic and exposure to bystanders.
- Disconnect all power and allow to sit for 5 minutes before you service this machine.
- Some components of the equipment can be heavy or awkward. Enlist the service of a second person when you do maintenance steps involving these components. Do not try to do heavy or awkward steps on your own.
- If replacement parts are necessary, use only genuine Nautilus replacement parts and hardware. Failure to use genuine replacement parts can cause a risk to users, keep the machine from operating correctly and will void the warranty.
- Be sure that all warning stickers and instructional placards applied to the product stay present and in good condition when doing maintenance or replacing components. If at any time the Warning labels become loose, unreadable or dislodged, replace the labels. If purchased in US/Canada, contact Customer Service for replacement labels. If purchased outside US/Canada, contact your local distributor for them.
- Do not try to change the design or functionality of the machine being serviced as this can adversely effect user safety and will void the warranty.
- Do not use the machine until all shrouds, instructions, warning labels and correct functionality have been verified and tested for correct performance.

### Tools Required (not included)

#2 Phillips screwdriver

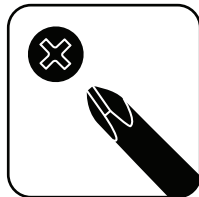

6mm hex wrench





**⚠ DANGER**

To reduce the risk of electrical shock or unsupervised usage of the equipment, always unplug the power cord from the wall outlet and wait 5 minutes before cleaning, maintaining or repairing this machine. Place the power cord in a secure location.

1. Unplug the power cord from the machine and wait 5 minutes. Place the power cord in a secure location.

2. . Using a #2 Phillips screwdriver, remove the 4 indicated screws (by arrows) from Lower Junction Covers.

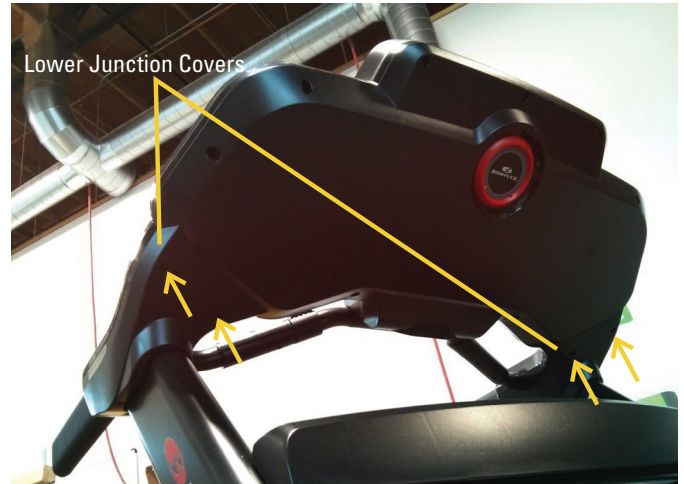

3. The Upper Junction Covers are released in two steps~ the inner snaps followed by the outer snap. From the outside of the machine, gently pinch both of the inside snaps (indicated with ovals) and roll the Upper Junction Cover up and outward from the machine.

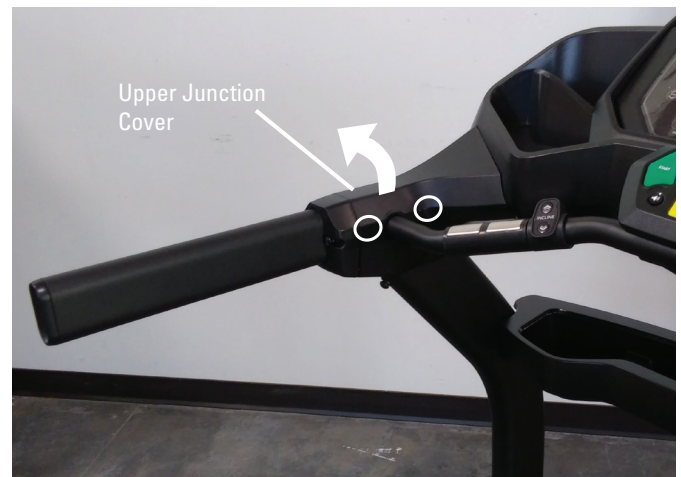

4. With the inner snaps of the Upper junction Covers released, gently pinch the outer snap (indicated by oval) to release the Upper Junction Cover.

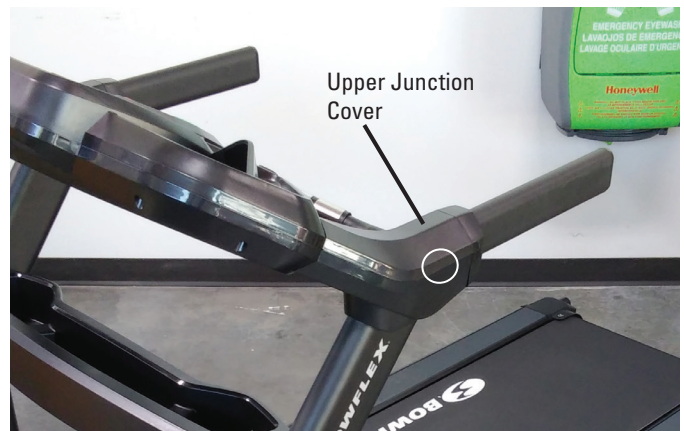

5. Gently pull out the Input/Output (I/O) and Grounding Cables from the Right Upright (indicated by arrow), and disconnect them. Do not allow the Cables to fall into the Right Upright. Secure them with a Zip-Tie, rubber band or piece of wire.

**Note:** Do not crimp the Cables.

6. Using a 6mm hex wrench, remove the 8 screws (indicated by ovals) that secure the Console Assembly to the Right and Left Uprights.

**Note:** To assist with re-assembly, be sure to note that the curved washers are used facing the rear of the machine.

7. Fully remove the Console and Handlebar Assembly from the Uprights.

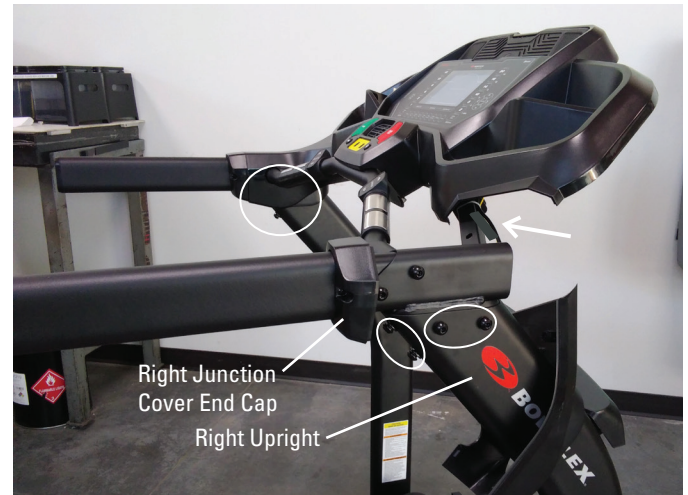

8. Remove both of the Lower Junction Covers from the Uprights.

9. Remove the Crossbar Tray from the Crossbar.

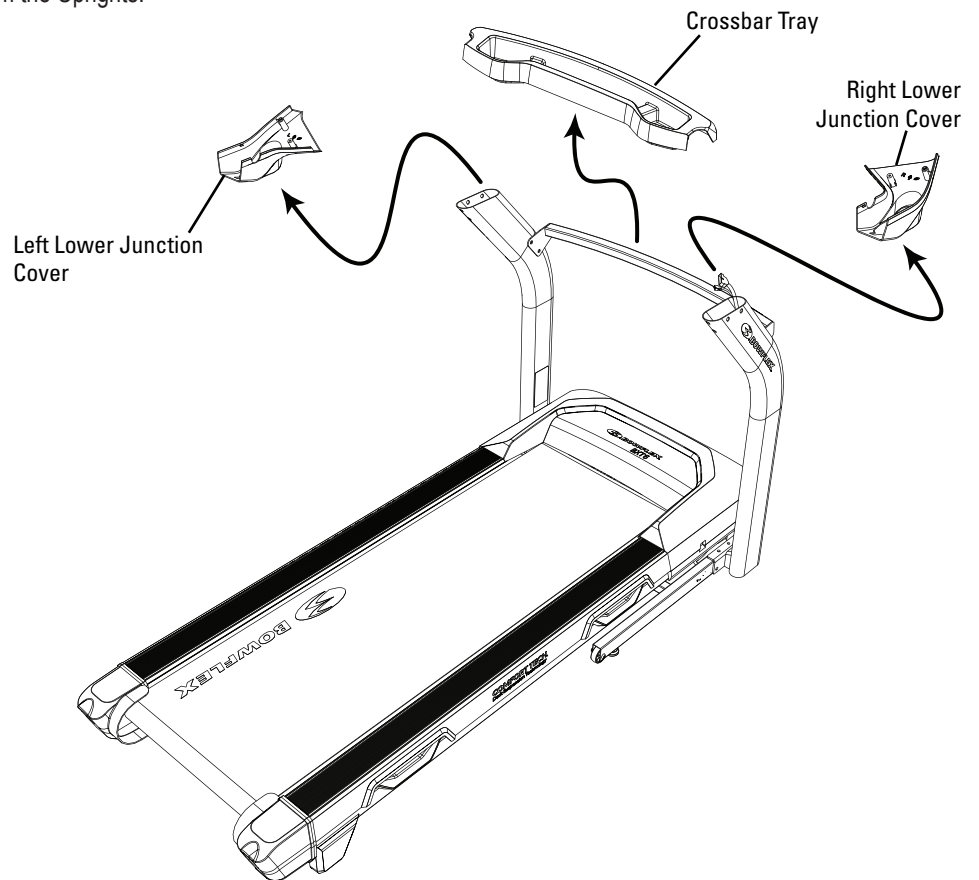

10. Using a 6mm hex wrench, remove the hardware that attaches the Crossbar to the Uprights.

**!** Be prepared to support the weight of the Crossbar before removing the hardware. Injury to you or damage to the machine can occur.

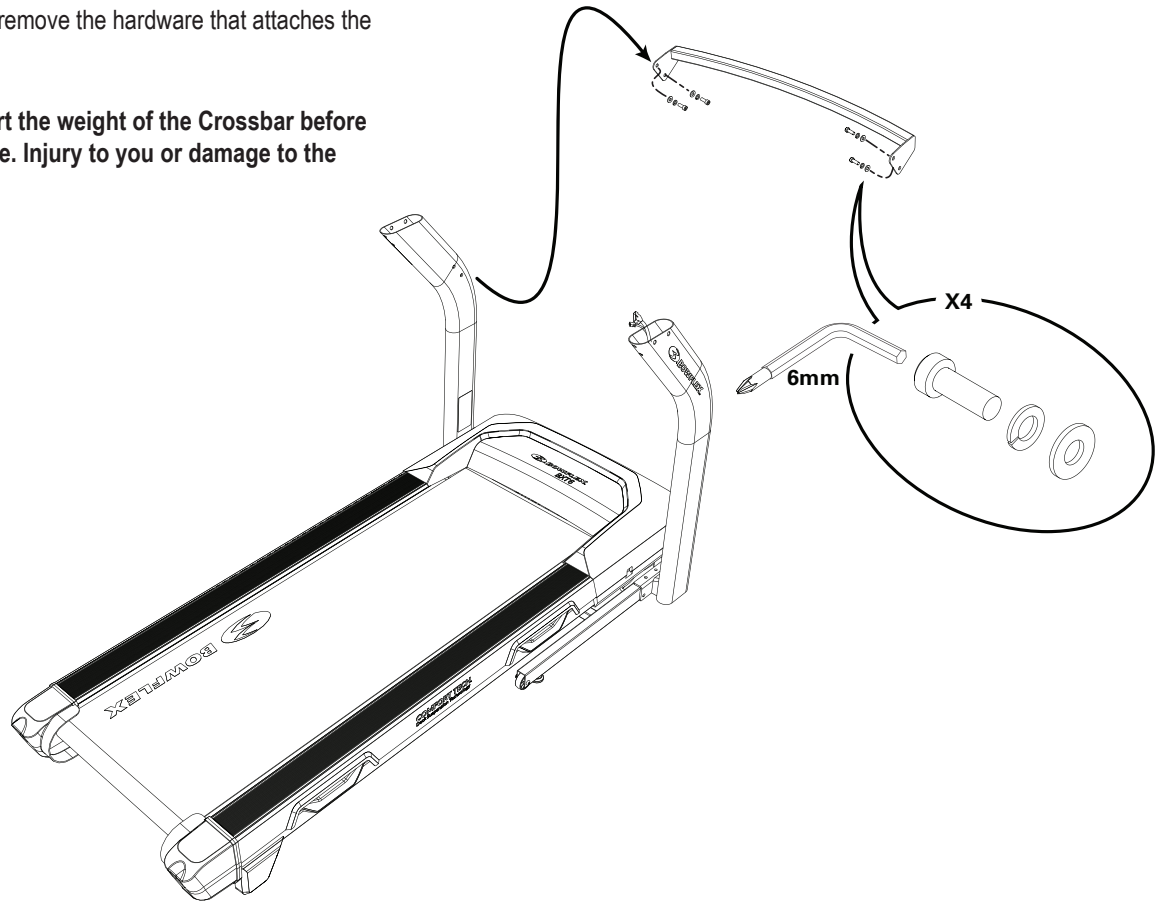

11. Make sure that there is safe clearance around, on and above the treadmill. Make sure there is no object to spill or cause blockage from the fully folded position.

**!** Be sure there is adequate height clearance for the raised deck.

12. Using the support bar found below the rear of the walking belt, lift the walking deck fully upward and engage the hydraulic lift. Be sure that the hydraulic lift is correctly locked in place. You will hear an audible click when the hydraulic lift shifts into the locked position.

**!** Use proper safety precautions and lifting techniques. Bend your knees and elbows, keep your back straight and pull up equally with both arms. Make sure that your own physical strength is capable of lifting the walking deck until it engages the locking mechanism. Use a second person if necessary.

**Do not use the walking belt or rear roller to lift the treadmill. These parts do not lock in place and can abruptly move. Injury to you or damage to the machine can occur.**

13. Make sure that the locking mechanism is engaged. Carefully pull back on the walking deck and make sure that it does not move. When you do this, keep clear of movement path in case the treadmill lock is not properly engaged.

**!** Do not lean against the treadmill when it is folded. Do not put items on it that could cause it to become unstable or fall.

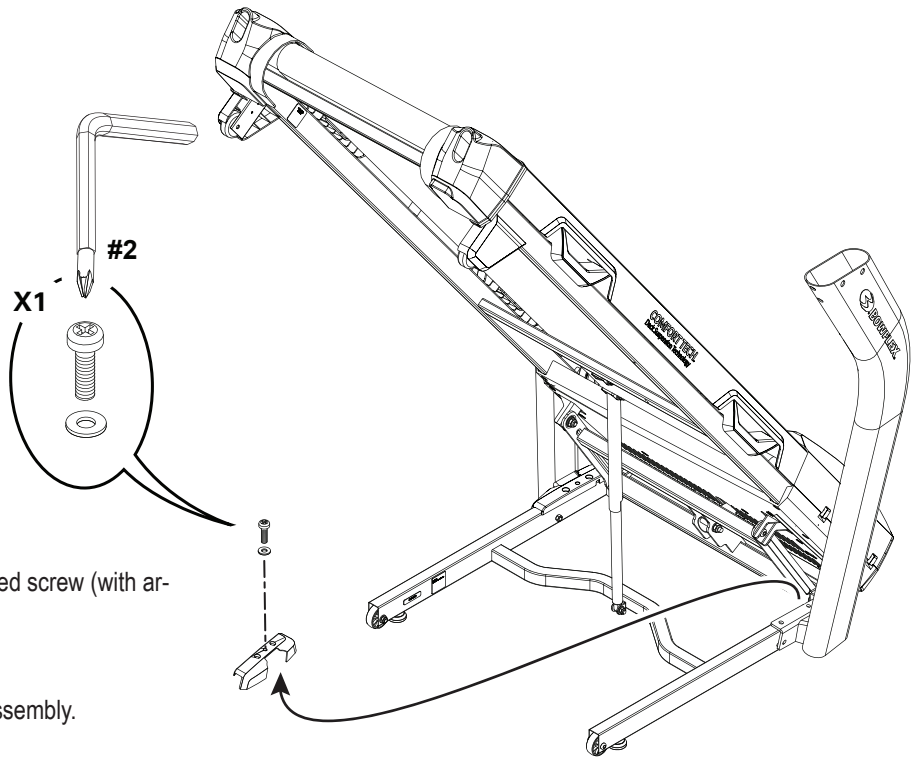

14. Using a #2 Phillips screwdriver, remove the indicated screw (with arrow) from the Right Base Shroud.

15. Remove the Right Base Shroud from the Frame Assembly.

16. Disconnect the Input/Output and Grounding Cables.

17. Using a 6mm hex wrench, remove the hardware that attaches the Right Upright.

**!** Be prepared to support the weight of the Right Upright before removing the hardware. Injury to you or damage to the machine can occur.

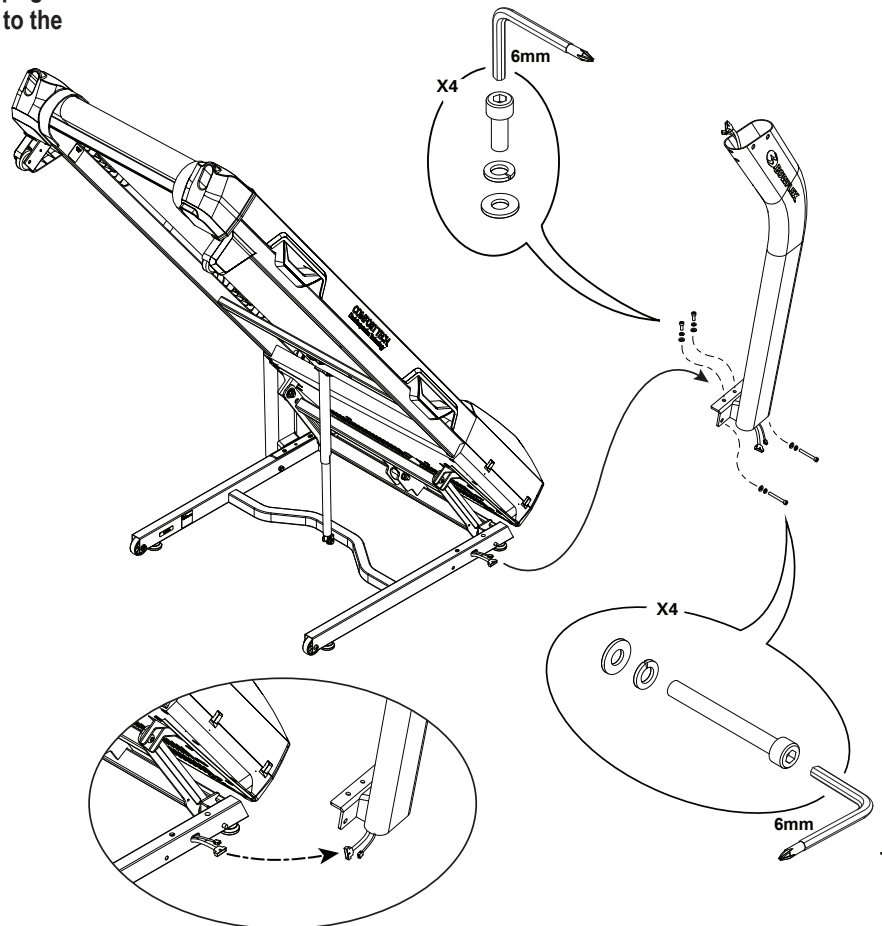

18. Connect the Cables from the new Right Upright, and attach it to the Frame Assembly.

**Note:** Be sure not to crimp the Cables when attaching the Right Upright to the Frame Assembly.

19. Make sure there is sufficient space to lower the walking deck.

**!** Keep a minimum clearance behind the machine of 79" (2 m) and 24" (0.6 m) on each side. This is the recommended safe distance for access, movement and emergency dismounts from the machine.

20. Make sure there is no object on or around the treadmill to spill or cause blockage from the fully unfolded position.

21. Slightly push the walking deck forward toward the console. With your foot lightly push the top part of the hydraulic lift forward until the locking tube releases and you can pull the walking deck away from the console. Hold up the rear of the walking deck, and move to the side of the machine.

**!** Keep clear of the movement path of the walking deck.

22. The hydraulic lift is set up to drop gradually. Hold onto the walking deck until approximately 2/3 of the movement down. Lower the weight with your legs. Be aware that the walking deck can possibly drop quickly in the last part of the movement.

23. Re-install all remaining parts that were removed in reverse order.

24. Final Inspection

Inspect your machine to ensure that all hardware is tight and components are properly assembled.

**!** Do not use until the machine has been fully assembled and inspected for correct performance in accordance with the Owner's Manual.





**NOTICE:** This document provides instructions for the replacement of the Rocker Switch on the Bowflex™ BXT6 / BXT028 Treadmill.

If you need assistance, please contact Customer Service (if purchased in US/Canada) or your local distributor (if purchased outside US/Canada). To find your local distributor, go to: [www.nautilusinternational.com](http://www.nautilusinternational.com)

 **This icon means a potentially hazardous situation which, if not avoided, could result in death or serious injury. Read and understand all Warnings on this machine.**

Nautilus, Inc., [www.NautilusInc.com](http://www.NautilusInc.com), 5415 Centerpoint Parkway, Groveport, OH 43125 U.S.A. - Customer Service: North America (800) 605-3369, [csnls@nautilus.com](mailto:csnls@nautilus.com) | outside U.S. [www.nautilusinternational.com](http://www.nautilusinternational.com) | Printed in China | © 2020 Nautilus, Inc. | Bowflex and the B logo are trademarks owned or licensed by Nautilus, Inc., registered or otherwise protected by common law in the United States and other nations. | **ORIGINAL DOCUMENT - ENGLISH VERSION ONLY**

### Important Safety Instructions - Before servicing or using this equipment, obey the following warnings:

 **This icon means a potentially hazardous situation which, if not avoided, could result in death or serious injury. Read and understand all Warnings on this machine.**

**⚠ DANGER** To reduce the risk of electrical shock or unsupervised usage of the equipment, always unplug the power cord from the wall outlet and wait 5 minutes before cleaning, maintaining or repairing this machine. Place the power cord in a secure location.

- Read and understand the Part Replacement Procedure before working on the machine. Failure to obey the instructions and safety warnings could cause injury to the service technician or bystanders.
- Keep bystanders, children and pets away from the product being serviced at all times.
- Make sure that the repair is done in an appropriate work space away from foot traffic and exposure to bystanders.
- Disconnect all power and allow to sit for 5 minutes before you service this machine.
- Some components of the equipment can be heavy or awkward. Enlist the service of a second person when you do maintenance steps involving these components. Do not try to do heavy or awkward steps on your own.
- If replacement parts are necessary, use only genuine Nautilus replacement parts and hardware. Failure to use genuine replacement parts can cause a risk to users, keep the machine from operating correctly and will void the warranty.
- Be sure that all warning stickers and instructional placards applied to the product stay present and in good condition when doing maintenance or replacing components. If at any time the Warning labels become loose, unreadable or dislodged, replace the labels. If purchased in US/Canada, contact Customer Service for replacement labels. If purchased outside US/Canada, contact your local distributor for them.
- Do not try to change the design or functionality of the machine being serviced as this can adversely effect user safety and will void the warranty.
- Do not use the machine until all shrouds, instructions, warning labels and correct functionality have been verified and tested for correct performance.

### Tools Required (not included)

#2 Phillips screwdriver



**⚠ DANGER** To reduce the risk of electrical shock or unsupervised usage of the equipment, always unplug the power cord from the wall outlet and wait 5 minutes before cleaning, maintaining or repairing this machine. Place the power cord in a secure location.

1. Unplug the power cord from the machine and wait 5 minutes. Place the power cord in a secure location.

2. Using a #2 Phillips screwdriver remove the 4 indicated screws, and two additional screws on the far side, from the Motor Cover and remove it.



3. Using a #2 Phillips screwdriver remove the 2 indicated screws from the MCB Cover and remove it.

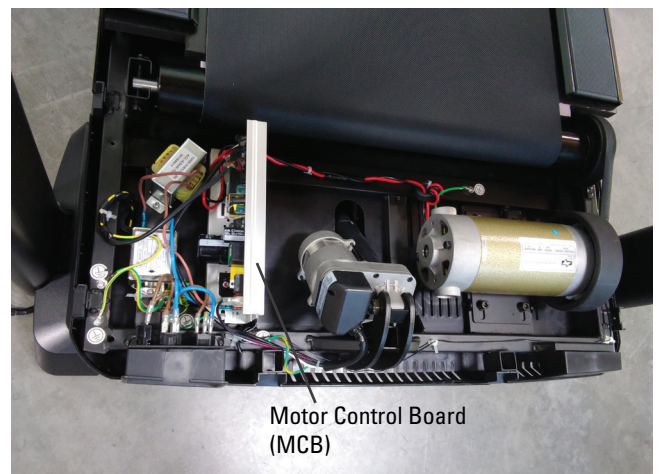
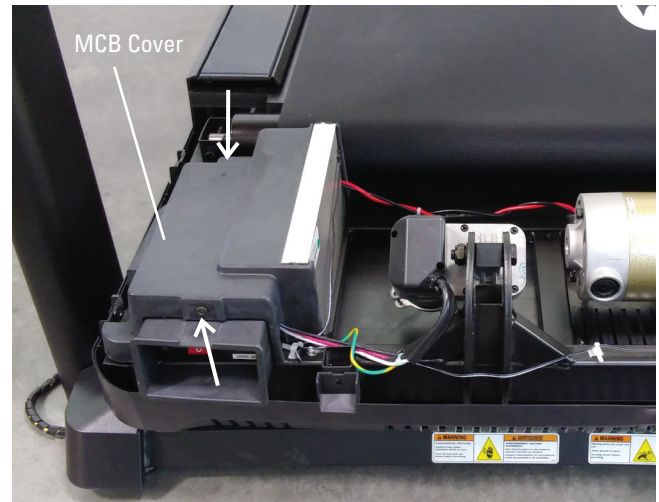

4. Release the Securing Clips from the Rocker Switch and remove it from the Frame.

5. Remove the connectors and attach them to the new Rocker Switch. Be sure to attach them in the same locations on the new Rocker Switch.

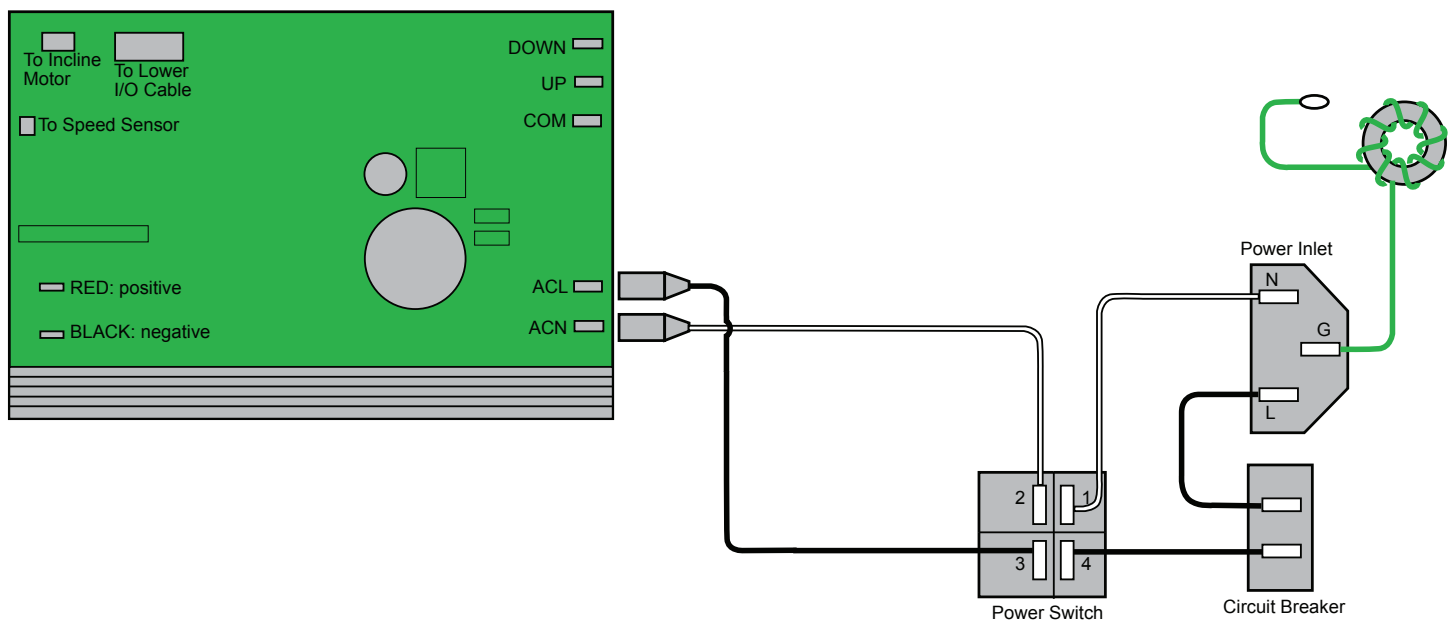
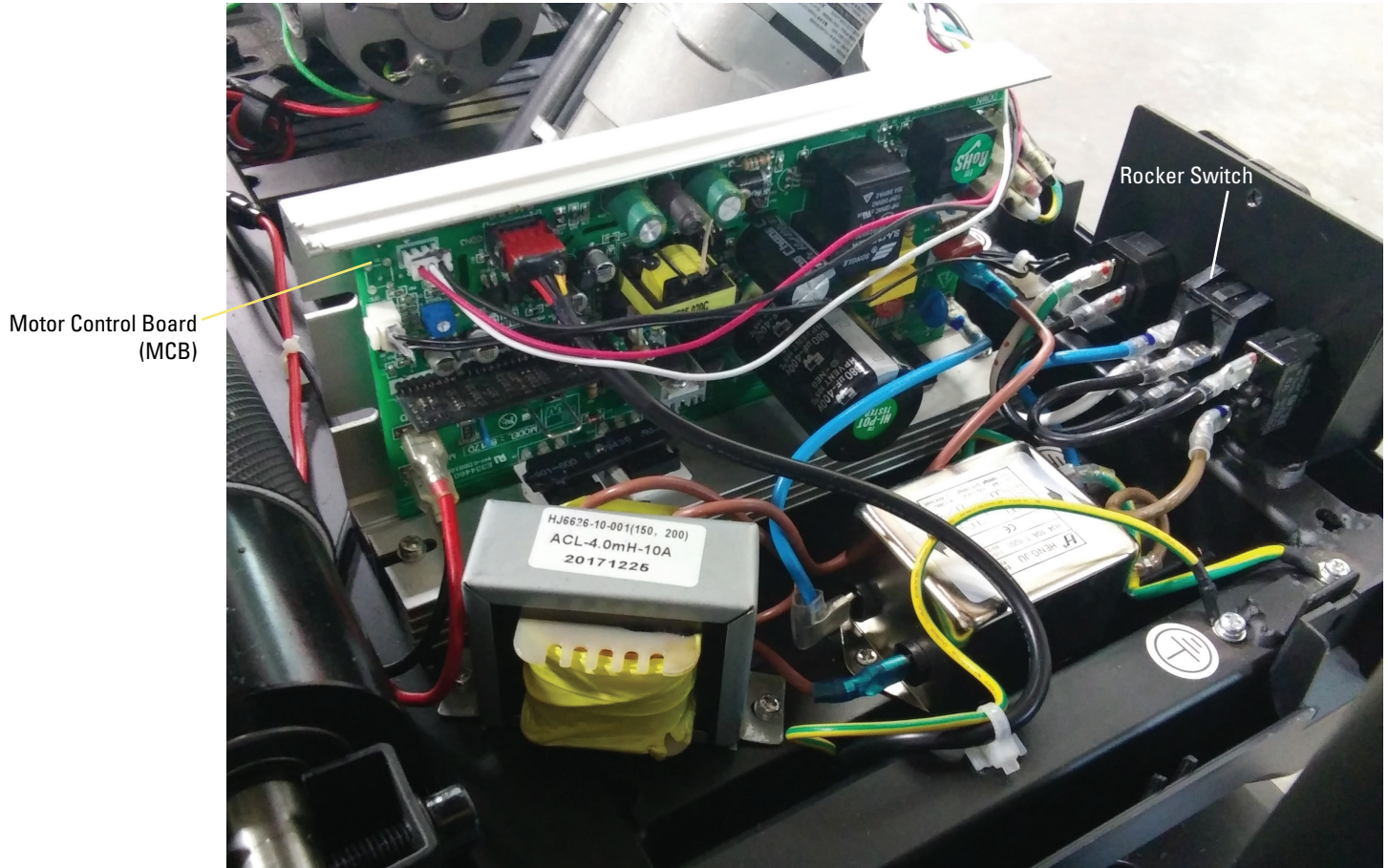

6. Insert the new Rocker Switch into the Frame, being sure the Securing Clips engage.

7. Re-install all remaining parts that were removed in reverse order.

8. Final Inspection

Inspect your machine to ensure that all hardware is tight and components are properly assembled.



**Do not use until the machine has been fully assembled and inspected for correct performance in accordance with the Owner's Manual.**

**NOTICE:** This document provides instructions for the replacement of the Side Rail on the Bowflex™ BXT6 / BXT028 Treadmill.

If you need assistance, please contact Customer Service (if purchased in US/Canada) or your local distributor (if purchased outside US/Canada). To find your local distributor, go to: [www.nautilusinternational.com](http://www.nautilusinternational.com)

 **This icon means a potentially hazardous situation which, if not avoided, could result in death or serious injury. Read and understand all Warnings on this machine.**

Nautilus, Inc., [www.NautilusInc.com](http://www.NautilusInc.com), 5415 Centerpoint Parkway, Groveport, OH 43125 U.S.A. - Customer Service: North America (800) 605-3369, [csnls@nautilus.com](mailto:csnls@nautilus.com) | outside U.S. [www.nautilusinternational.com](http://www.nautilusinternational.com) | Printed in China | © 2020 Nautilus, Inc. | Bowflex and the B logo are trademarks owned or licensed by Nautilus, Inc., registered or otherwise protected by common law in the United States and other nations. | **ORIGINAL DOCUMENT - ENGLISH VERSION ONLY**

### Important Safety Instructions - Before servicing or using this equipment, obey the following warnings:

 **This icon means a potentially hazardous situation which, if not avoided, could result in death or serious injury. Read and understand all Warnings on this machine.**

**⚠ DANGER** To reduce the risk of electrical shock or unsupervised usage of the equipment, always unplug the power cord from the wall outlet and wait 5 minutes before cleaning, maintaining or repairing this machine. Place the power cord in a secure location.

- Read and understand the Part Replacement Procedure before working on the machine. Failure to obey the instructions and safety warnings could cause injury to the service technician or bystanders.
- Keep bystanders, children and pets away from the product being serviced at all times.
- Make sure that the repair is done in an appropriate work space away from foot traffic and exposure to bystanders.
- Disconnect all power and allow to sit for 5 minutes before you service this machine.
- Some components of the equipment can be heavy or awkward. Enlist the service of a second person when you do maintenance steps involving these components. Do not try to do heavy or awkward steps on your own.
- If replacement parts are necessary, use only genuine Nautilus replacement parts and hardware. Failure to use genuine replacement parts can cause a risk to users, keep the machine from operating correctly and will void the warranty.
- Be sure that all warning stickers and instructional placards applied to the product stay present and in good condition when doing maintenance or replacing components. If at any time the Warning labels become loose, unreadable or dislodged, replace the labels. If purchased in US/Canada, contact Customer Service for replacement labels. If purchased outside US/Canada, contact your local distributor for them.
- Do not try to change the design or functionality of the machine being serviced as this can adversely effect user safety and will void the warranty.
- Do not use the machine until all shrouds, instructions, warning labels and correct functionality have been verified and tested for correct performance.

### Tools Required (not included)

#2 Phillips screwdriver

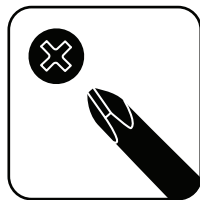



**⚠ DANGER** To reduce the risk of electrical shock or unsupervised usage of the equipment, always unplug the power cord from the wall outlet and wait 5 minutes before cleaning, maintaining or repairing this machine. Place the power cord in a secure location.

1. Unplug the power cord from the machine and wait 5 minutes. Place the power cord in a secure location.

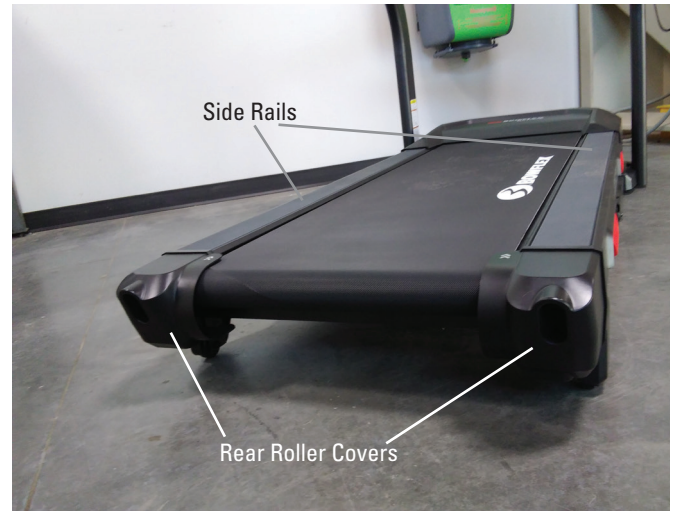

2. Using a #2 Phillips screwdriver, remove the indicated screw (with arrow) from each of the Rear Roller Covers.

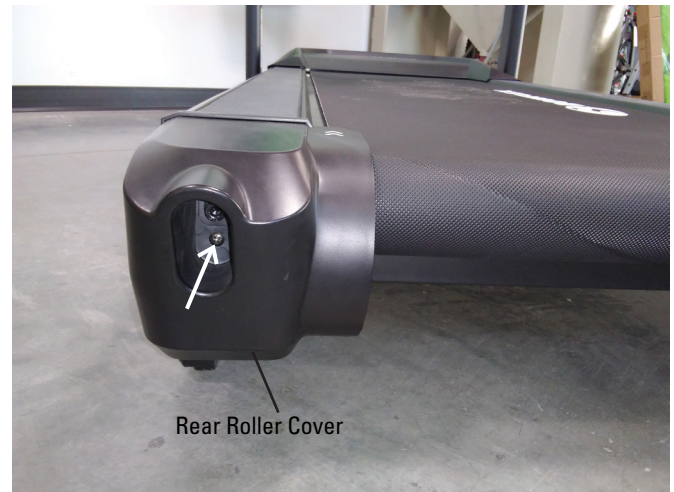

3. Make sure that there is safe clearance around, on and above the treadmill. Make sure there is no object to spill or cause blockage from the fully folded position.

**⚠** Be sure there is adequate height clearance for the raised deck.

4. Using the support bar found below the rear of the walking belt, lift the walking deck fully upward and engage the hydraulic lift. Be sure that the hydraulic lift is correctly locked in place. You will hear an audible click when the hydraulic lift shifts into the locked position.

**⚠** Use proper safety precautions and lifting techniques. Bend your knees and elbows, keep your back straight and pull up equally with both arms. Make sure that your own physical strength is capable of lifting the walking deck until it engages the locking mechanism. Use a second person if necessary.

**Do not use the walking belt or rear roller to lift the treadmill. These parts do not lock in place and can abruptly move. Injury to you or damage to the machine can occur.**

5. Make sure that the locking mechanism is engaged. Carefully pull back on the walking deck and make sure that it does not move. When you do this, keep clear of movement path in case the treadmill lock is not properly engaged.

**⚠** Do not lean against the treadmill when it is folded. Do not put items on it that could cause it to become unstable or fall.

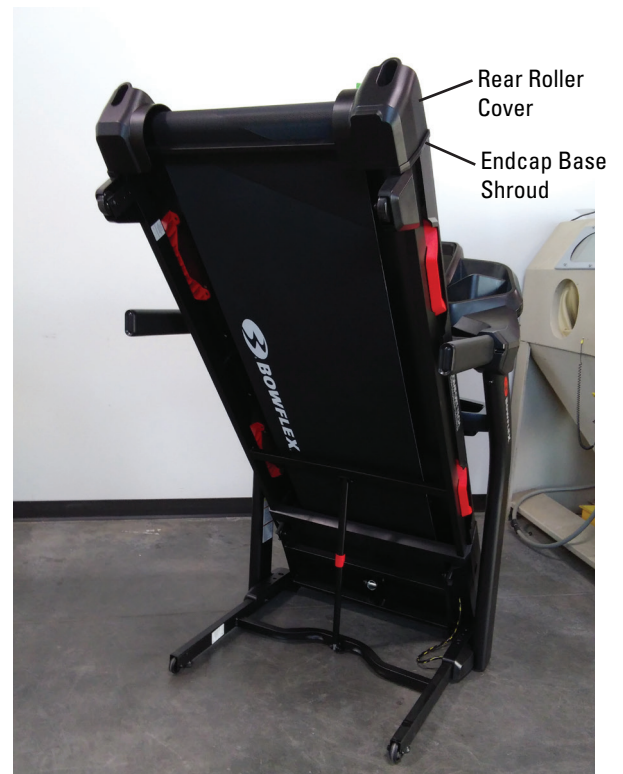

6. Using a #2 Phillips screwdriver, remove the indicated screw (with arrow) from each of the Rear Roller Covers.

7. Remove the Rear Roller Covers and Endcap Base Shrouds.

**Note:** To assist with reassembly, be sure to notice how the Endcap Base Shroud is secured by the Rear Roller Cover.

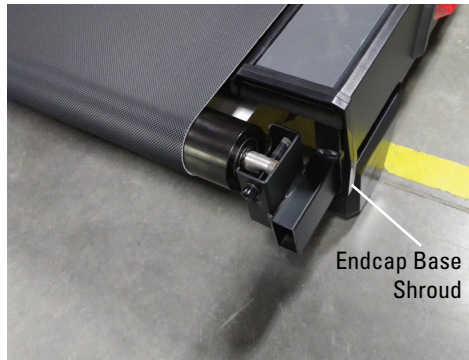

8. Using a #2 Phillips screwdriver, remove the 12 indicated screws from below the Walking Deck that attach the Side Rails.

9. Remove the old Side Rails from the Walking Deck, and replace with the new Side Rails.

10. Re-install all remaining parts that were removed in reverse order.



11. Make sure there is sufficient space to lower the walking deck.

**!** Keep a minimum clearance behind the machine of 79" (2 m) and 24" (0.6 m) on each side. This is the recommended safe distance for access, movement and emergency dismounts from the machine.

12. Make sure there is no object on or around the treadmill to spill or cause blockage from the fully unfolded position.

13. Slightly push the walking deck forward toward the console. With your foot lightly push the top part of the hydraulic lift forward until the locking tube releases and you can pull the walking deck away from the console. Hold up the rear of the walking deck, and move to the side of the machine.

**!** Keep clear of the movement path of the walking deck.

14. The hydraulic lift is set up to drop gradually. Hold onto the walking deck until approximately 2/3 of the movement down. Lower the weight with your legs. Be aware that the walking deck can possibly drop quickly in the last part of the movement.

15. Final Inspection

Inspect your machine to ensure that all hardware is tight and components are properly assembled.

**!** Do not use until the machine has been fully assembled and inspected for correct performance in accordance with the Owner's Manual.





**NOTICE:** This document provides instructions for the replacement of the Speed Sensor Assembly on the Bowflex™ BXT6 / BXT028 Treadmill.

If you need assistance, please contact Customer Service (if purchased in US/Canada) or your local distributor (if purchased outside US/Canada). To find your local distributor, go to: [www.nautilusinternational.com](http://www.nautilusinternational.com)

 **This icon means a potentially hazardous situation which, if not avoided, could result in death or serious injury. Read and understand all Warnings on this machine.**

Nautilus, Inc., [www.NautilusInc.com](http://www.NautilusInc.com), 5415 Centerpoint Parkway, Groveport, OH 43125 U.S.A. - Customer Service: North America (800) 605-3369, [csnls@nautilus.com](mailto:csnls@nautilus.com) | outside U.S. [www.nautilusinternational.com](http://www.nautilusinternational.com) | Printed in China | © 2018 Nautilus, Inc. | Bowflex and the B logo are trademarks owned or licensed by Nautilus, Inc., registered or otherwise protected by common law in the United States and other nations. | **ORIGINAL DOCUMENT - ENGLISH VERSION ONLY**

### Important Safety Instructions - Before servicing or using this equipment, obey the following warnings:

 **This icon means a potentially hazardous situation which, if not avoided, could result in death or serious injury. Read and understand all Warnings on this machine.**

**⚠ DANGER** To reduce the risk of electrical shock or unsupervised usage of the equipment, always unplug the power cord from the wall outlet and wait 5 minutes before cleaning, maintaining or repairing this machine. Place the power cord in a secure location.

- Read and understand the Part Replacement Procedure before working on the machine. Failure to obey the instructions and safety warnings could cause injury to the service technician or bystanders.
- Keep bystanders, children and pets away from the product being serviced at all times.
- Make sure that the repair is done in an appropriate work space away from foot traffic and exposure to bystanders.
- Disconnect all power and allow to sit for 5 minutes before you service this machine.
- Some components of the equipment can be heavy or awkward. Enlist the service of a second person when you do maintenance steps involving these components. Do not try to do heavy or awkward steps on your own.
- If replacement parts are necessary, use only genuine Nautilus replacement parts and hardware. Failure to use genuine replacement parts can cause a risk to users, keep the machine from operating correctly and will void the warranty.
- Be sure that all warning stickers and instructional placards applied to the product stay present and in good condition when doing maintenance or replacing components. If at any time the Warning labels become loose, unreadable or dislodged, replace the labels. If purchased in US/Canada, contact Customer Service for replacement labels. If purchased outside US/Canada, contact your local distributor for them.
- Do not try to change the design or functionality of the machine being serviced as this can adversely effect user safety and will void the warranty.
- Do not use the machine until all shrouds, instructions, warning labels and correct functionality have been verified and tested for correct performance.

### Tools Required (not included)

#2 Phillips screwdriver



Replacement Zip-Ties ( x4 )



**⚠ DANGER** To reduce the risk of electrical shock or unsupervised usage of the equipment, always unplug the power cord from the wall outlet and wait 5 minutes before cleaning, maintaining or repairing this machine. Place the power cord in a secure location.

1. Unplug the power cord from the machine and wait 5 minutes. Place the power cord in a secure location.

2. Using a #2 Phillips screwdriver remove the 4 indicated screws, and two additional screws on the far side, from the Motor Cover and remove it.



3. Using a #2 Phillips screwdriver remove the 2 indicated screws from the MCB Cover and remove it.

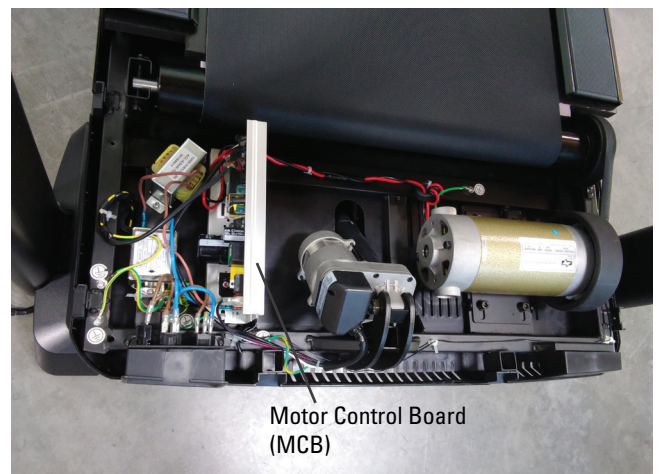
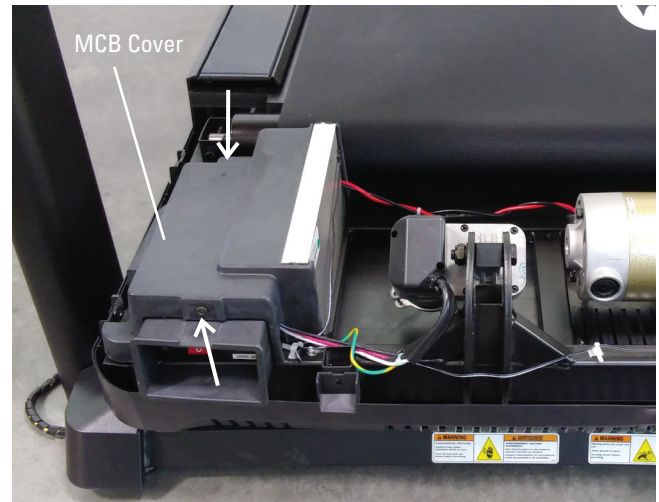



4. Using a #2 Phillips screwdriver, remove the 2 indicated screws (by arrow) that attach the Speed Sensor to the Frame near the Drive Pulley.

**Note:** Be sure to observe the distance from the Speed Sensor to the Drive Pulley. This distance affects the effectiveness of the Speed Sensor and will be used for the re-assembly process.

5. Cut the 4 Zip-Ties that secure the Speed Sensor Cable.

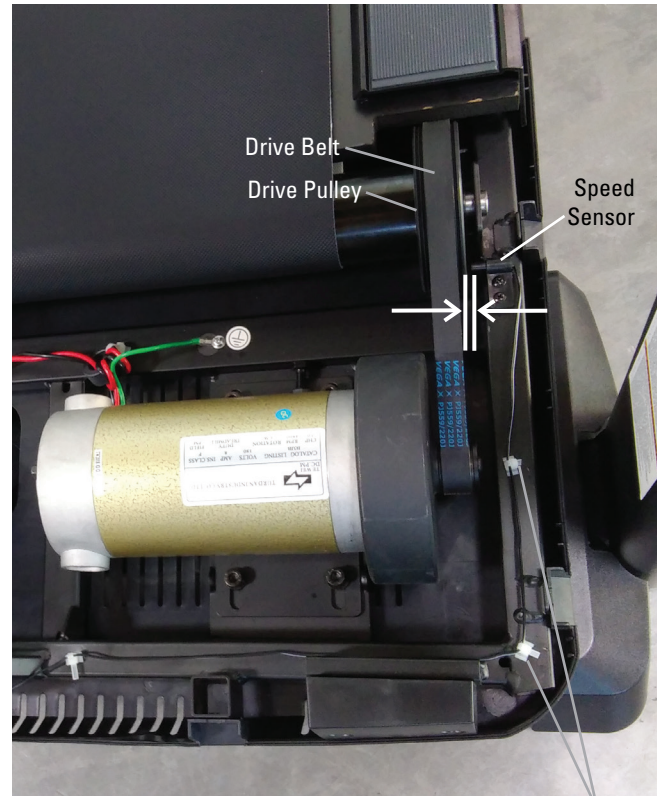
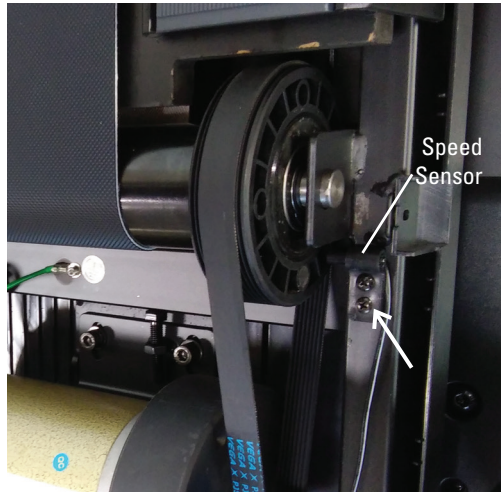

Speed Sensor Cable Zip-Tie

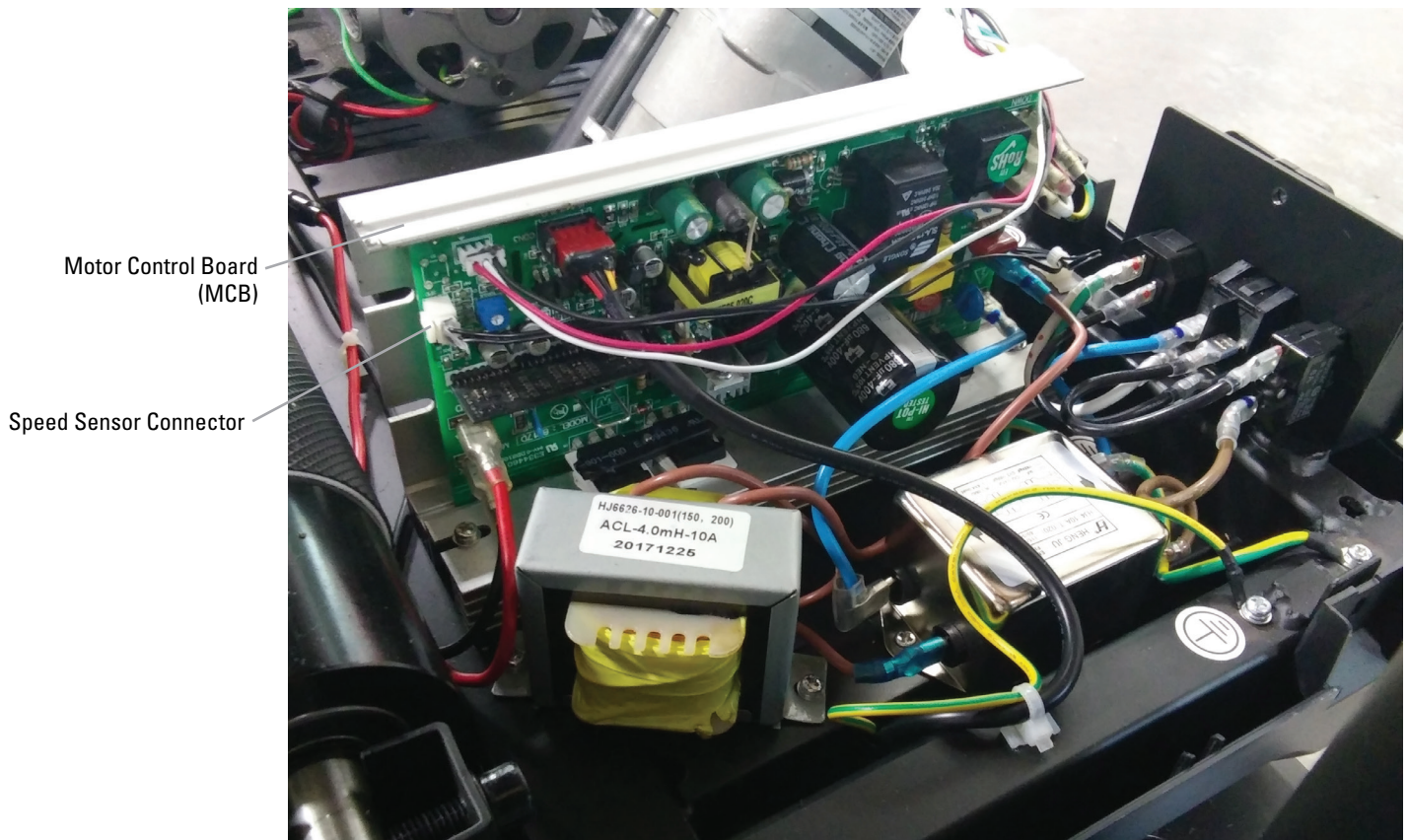

**Note:** The above photo shows the BXT028 machine, with Choke and Filter included.

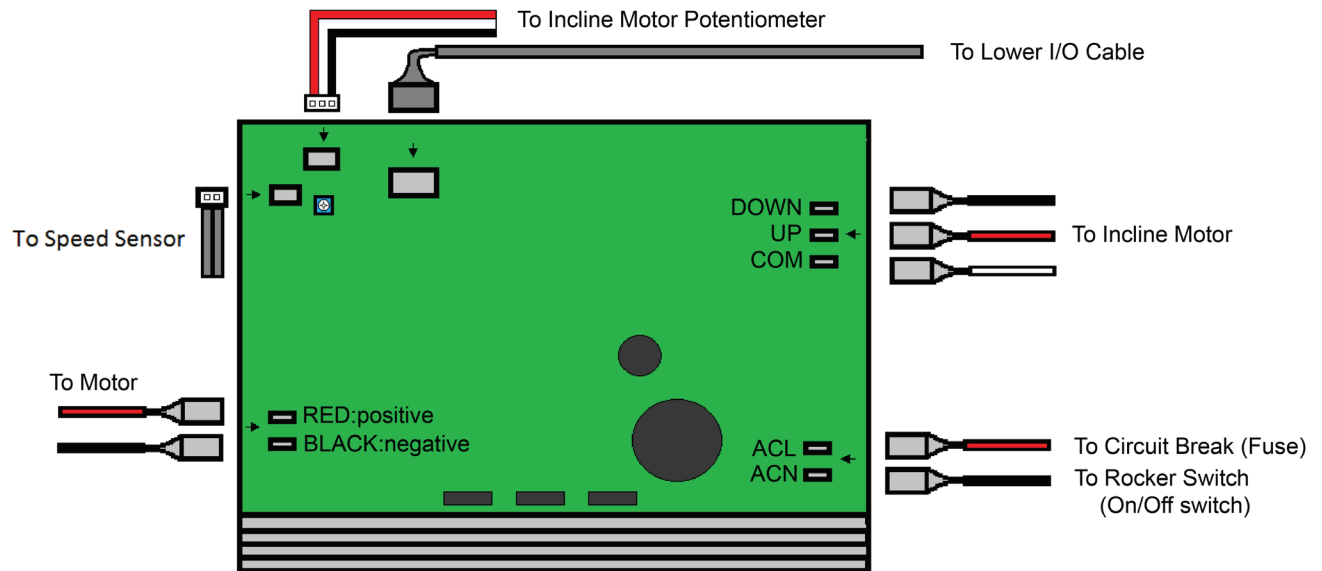

6. Remove the Speed Sensor Connector from the Motor Control Board.

7. Attach the new Speed Sensor Connector to the Motor Control Board.

8. Route the new Speed Sensor Cable along the Frame.

9. Using replacement Zip-Ties, secure the Speed Sensor Cable to the Frame and trim the excess from the Zip-Ties. Be sure not to cut the Speed Sensor Cable.

10. Using a #2 Phillips screwdriver, attach the new Speed Sensor and adjust it to be the same distance as the old Sensor from the Drive Pulley.

11. Re-install all remaining parts that were removed in reverse order.

12. Final Inspection

Inspect your machine to ensure that all hardware is tight and components are properly assembled.



**Do not use until the machine has been fully assembled and inspected for correct performance in accordance with the Owner's Manual.**

**NOTICE:** This document provides instructions for the replacement of the Transport Wheel on the Bowflex™ BXT6 / BXT028 Treadmill.

If you need assistance, please contact Customer Service (if purchased in US/Canada) or your local distributor (if purchased outside US/Canada). To find your local distributor, go to: [www.nautilusinternational.com](http://www.nautilusinternational.com)

 **This icon means a potentially hazardous situation which, if not avoided, could result in death or serious injury. Read and understand all Warnings on this machine.**

Nautilus, Inc., [www.NautilusInc.com](http://www.NautilusInc.com), 5415 Centerpoint Parkway, Groveport, OH 43125 U.S.A. - Customer Service: North America (800) 605-3369, [csnls@nautilus.com](mailto:csnls@nautilus.com) | outside U.S. [www.nautilusinternational.com](http://www.nautilusinternational.com) | Printed in China | © 2020 Nautilus, Inc. | Bowflex and the B logo are trademarks owned or licensed by Nautilus, Inc., registered or otherwise protected by common law in the United States and other nations. | **ORIGINAL DOCUMENT - ENGLISH VERSION ONLY**

### Important Safety Instructions - Before servicing or using this equipment, obey the following warnings:

 **This icon means a potentially hazardous situation which, if not avoided, could result in death or serious injury. Read and understand all Warnings on this machine.**

**⚠ DANGER** To reduce the risk of electrical shock or unsupervised usage of the equipment, always unplug the power cord from the wall outlet and wait 5 minutes before cleaning, maintaining or repairing this machine. Place the power cord in a secure location.

- Read and understand the Part Replacement Procedure before working on the machine. Failure to obey the instructions and safety warnings could cause injury to the service technician or bystanders.
- Keep bystanders, children and pets away from the product being serviced at all times.
- Make sure that the repair is done in an appropriate work space away from foot traffic and exposure to bystanders.
- Disconnect all power and allow to sit for 5 minutes before you service this machine.
- Some components of the equipment can be heavy or awkward. Enlist the service of a second person when you do maintenance steps involving these components. Do not try to do heavy or awkward steps on your own.
- If replacement parts are necessary, use only genuine Nautilus replacement parts and hardware. Failure to use genuine replacement parts can cause a risk to users, keep the machine from operating correctly and will void the warranty.
- Be sure that all warning stickers and instructional placards applied to the product stay present and in good condition when doing maintenance or replacing components. If at any time the Warning labels become loose, unreadable or dislodged, replace the labels. If purchased in US/Canada, contact Customer Service for replacement labels. If purchased outside US/Canada, contact your local distributor for them.
- Do not try to change the design or functionality of the machine being serviced as this can adversely effect user safety and will void the warranty.
- Do not use the machine until all shrouds, instructions, warning labels and correct functionality have been verified and tested for correct performance.

### Tools Required (not included)

6mm hex wrench



13mm wrench

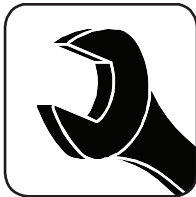



**⚠ DANGER** To reduce the risk of electrical shock or unsupervised usage of the equipment, always unplug the power cord from the wall outlet and wait 5 minutes before cleaning, maintaining or repairing this machine. Place the power cord in a secure location.

1. Unplug the power cord from the machine and wait 5 minutes. Place the power cord in a secure location.

2. Using the support bar found below the rear of the walking belt, lift the walking deck fully upward and engage the hydraulic lift. Be sure that the hydraulic lift is correctly locked in place. You will hear an audible click when the hydraulic lift shifts into the locked position..

**⚠** Be sure there is adequate height clearance for the raised deck.

3. Using the support bar found below the rear of the walking belt, push the Deck Release Handle and lift the walking deck fully upward and engage the hydraulic lift. Be sure that the hydraulic lift is correctly locked in place. You will hear an audible click when the hydraulic lift shifts into the locked position.

**⚠** Use proper safety precautions and lifting techniques. Bend your knees and elbows, keep your back straight and pull up equally with both arms. Straighten your legs to lift. Make sure that your own physical strength is capable of lifting the walking deck until it engages the locking mechanism. Use a second person if necessary.

Do not use the walking belt or rear roller to lift the treadmill. These parts do not lock in place and can abruptly move. Injury to you or damage to the machine can occur.

4. Make sure that the locking mechanism is engaged. Carefully pull back on the walking deck and make sure that it does not move. When you do this, keep clear of movement path in case the treadmill lock is not properly engaged.

**⚠** Do not lean against the treadmill when it is folded. Do not put items on it that could cause it to become unstable or fall.



5. Using a 13mm wrench and a 6mm hex wrench, remove the indicated hardware from the Transport Wheel.

6. Using a 13mm wrench and a 6mm hex wrench, attach the new Transport Wheel to the Frame Assembly.



7. Make sure there is sufficient space to lower the walking deck.

**!** Keep a minimum clearance behind the machine of 79" (2 m) and 24" (0.6 m) on each side. This is the recommended safe distance for access, movement and emergency dismounts from the machine.

8. Make sure there is no object on or around the treadmill to spill or cause blockage from the fully unfolded position.

9. Slightly push the walking deck forward toward the console. With your foot lightly push the top part of the hydraulic lift forward until the locking tube releases and you can pull the walking deck away from the console. Hold up the rear of the walking deck, and move to the side of the machine.

**!** Keep clear of the movement path of the walking deck.

10. The hydraulic lift is set up to drop gradually. Hold onto the walking deck until approximately 2/3 of the movement down. Lower the weight with your legs. Be aware that the walking deck can possibly drop quickly in the last part of the movement.

11. Final Inspection  
Inspect your machine to ensure that all hardware is tight and components are properly assembled.

**!** Do not use until the machine has been fully assembled and inspected for correct performance in accordance with the Owner's Manual.



**NOTICE:** This document provides instructions for the replacement of the Walking Belt on the Bowflex™ BXT6 / BXT028 Treadmill.

If you need assistance, please contact Customer Service (if purchased in US/Canada) or your local distributor (if purchased outside US/Canada). To find your local distributor, go to: [www.nautilusinternational.com](http://www.nautilusinternational.com)

**This icon means a potentially hazardous situation which, if not avoided, could result in death or serious injury. Read and understand all Warnings on this machine.**

Nautilus, Inc., [www.NautilusInc.com](http://www.NautilusInc.com), 5415 Centerpoint Parkway, Groveport, OH 43125 U.S.A. - Customer Service: North America (800) 605-3369, [csnls@nautilus.com](mailto:csnls@nautilus.com) | outside U.S. [www.nautilusinternational.com](http://www.nautilusinternational.com) | Printed in China | © 2018 Nautilus, Inc. | Bowflex and the B logo are trademarks owned or licensed by Nautilus, Inc., registered or otherwise protected by common law in the United States and other nations. | **ORIGINAL DOCUMENT - ENGLISH VERSION ONLY**

### Important Safety Instructions - Before servicing or using this equipment, obey the following warnings:

**This icon means a potentially hazardous situation which, if not avoided, could result in death or serious injury. Read and understand all Warnings on this machine.**

**⚠ DANGER** To reduce the risk of electrical shock or unsupervised usage of the equipment, always unplug the power cord from the wall outlet and wait 5 minutes before cleaning, maintaining or repairing this machine. Place the power cord in a secure location.

- Read and understand the Part Replacement Procedure before working on the machine. Failure to obey the instructions and safety warnings could cause injury to the service technician or bystanders.
- Keep bystanders, children and pets away from the product being serviced at all times.
- Make sure that the repair is done in an appropriate work space away from foot traffic and exposure to bystanders.
- Disconnect all power and allow to sit for 5 minutes before you service this machine.
- Some components of the equipment can be heavy or awkward. Enlist the service of a second person when you do maintenance steps involving these components. Do not try to do heavy or awkward steps on your own.
- If replacement parts are necessary, use only genuine Nautilus replacement parts and hardware. Failure to use genuine replacement parts can cause a risk to users, keep the machine from operating correctly and will void the warranty.
- Be sure that all warning stickers and instructional placards applied to the product stay present and in good condition when doing maintenance or replacing components. If at any time the Warning labels become loose, unreadable or dislodged, replace the labels. If purchased in US/Canada, contact Customer Service for replacement labels. If purchased outside US/Canada, contact your local distributor for them.
- Do not try to change the design or functionality of the machine being serviced as this can adversely effect user safety and will void the warranty.
- Do not use the machine until all shrouds, instructions, warning labels and correct functionality have been verified and tested for correct performance.

### Tools Required (not included)

#2 Phillips screwdriver

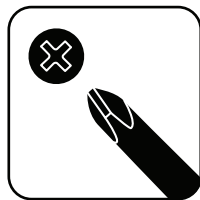

8300 Silicone Spray or Lube-N-Walk® Treadmill Lubrication Kit

6mm hex wrench



13mm wrench



**⚠ DANGER**

To reduce the risk of electrical shock or unsupervised usage of the equipment, always unplug the power cord from the wall outlet and wait 5 minutes before cleaning, maintaining or repairing this machine. Place the power cord in a secure location.

1. Unplug the power cord from the machine and wait 5 minutes. Place the power cord in a secure location.

2. Using a 6mm hex wrench, loosen the Walking Belt with the Adjustment Bolts found on both Rear Roller Covers. Loosen the Adjustment Bolts only until the Walking Belt slides past the Rollers freely. Do not loosen the Adjustment Bolts too much or the Rear Roller may detach.

**Note:** Be sure to record the number of turns of the Adjustment Bolts it takes to loosen the Walking Belt. This will assist with reassembly.

3. Using a #2 Phillips screwdriver, remove the indicated screw (with arrow) from the Rear Roller Cover.

4. Make sure that there is safe clearance around, on and above the treadmill. Make sure there is no object to spill or cause blockage from the fully folded position.



Be sure there is adequate height clearance for the raised deck.

5. Using the support bar found below the rear of the walking belt, lift the walking deck fully upward and engage the hydraulic lift. Be sure that the hydraulic lift is correctly locked in place. You will hear an audible click when the hydraulic lift shifts into the locked position.



Use proper safety precautions and lifting techniques. Bend your knees and elbows, keep your back straight and pull up equally with both arms. Make sure that your own physical strength is capable of lifting the walking deck until it engages the locking mechanism. Use a second person if necessary.

Do not use the walking belt or rear roller to lift the treadmill. These parts do not lock in place and can abruptly move. Injury to you or damage to the machine can occur.

6. Make sure that the locking mechanism is engaged. Carefully pull back on the walking deck and make sure that it does not move. When you do this, keep clear of movement path in case the treadmill lock is not properly engaged.



Do not lean against the treadmill when it is folded. Do not put items on it that could cause it to become unstable or fall.

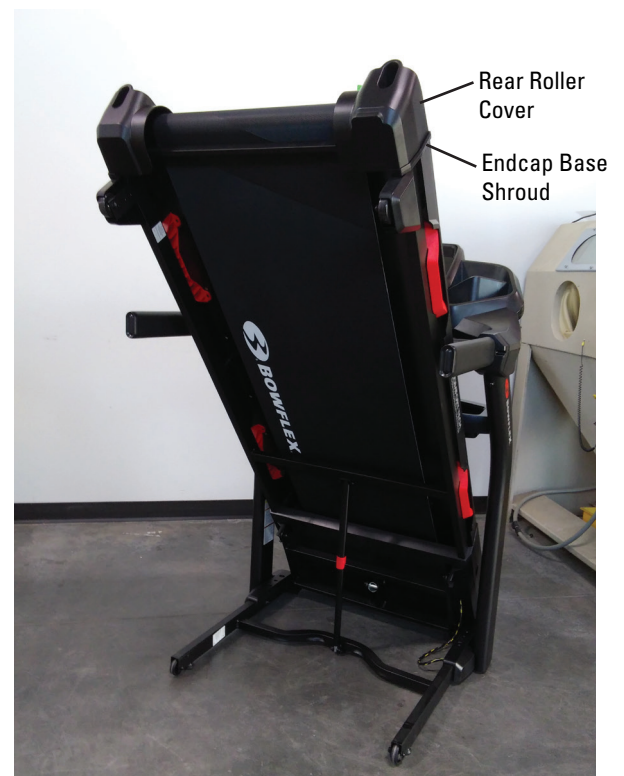
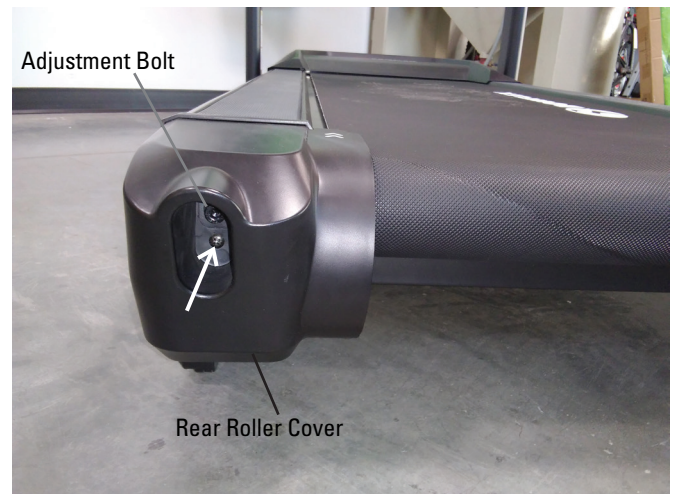
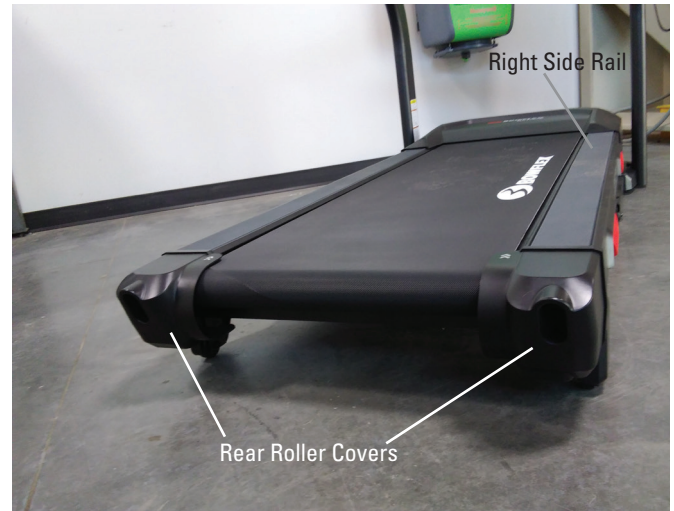

7. Using a #2 Phillips screwdriver, remove the indicated screw (with arrow) from the Rear Roller Cover.

8. Remove the Rear Roller Covers and Endcap Base Shrouds.

**Note:** To assist with reassembly, be sure to notice how the Endcap Base Shroud is secured by the Rear Roller Cover.

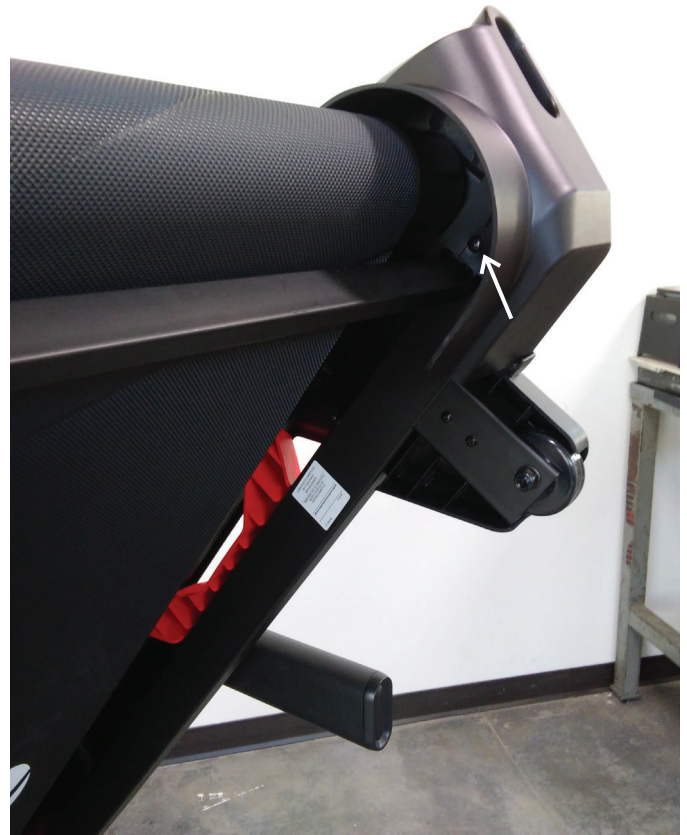
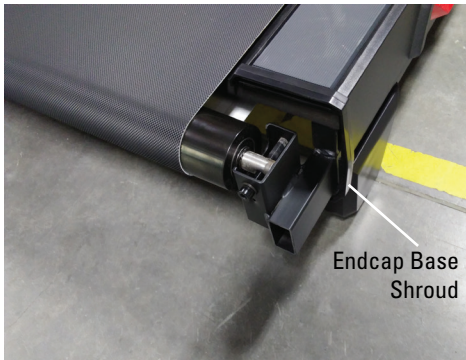

9. Using a #2 Phillips screwdriver, remove the 6 indicated screws from below the Walking Deck that attach the Right Side Rail.

10. Remove the Right Side Rail from the Walking Deck.





11. Using a #2 Phillips screwdriver remove the 4 indicated screws from the Right Deck Suspensions.

12. Remove the Right Deck Suspension.

13. Make sure there is sufficient space to lower the walking deck.

**⚠ Keep a minimum clearance behind the machine of 79" (2 m) and 24" (0.6 m) on each side. This is the recommended safe distance for access, movement and emergency dismounts from the machine.**

14. Make sure there is no object on or around the treadmill to spill or cause blockage from the fully unfolded position.

15. Slightly push the walking deck forward toward the console. With your foot lightly push the top part of the hydraulic lift forward until the locking tube releases and you can pull the walking deck away from the console. Hold up the rear of the walking deck, and move to the side of the machine.

**⚠ Keep clear of the movement path of the walking deck.**

16. The hydraulic lift is set up to drop gradually. Hold onto the walking deck until approximately 2/3 of the movement down. Lower the weight with your legs. Be aware that the walking deck can possibly drop quickly in the last part of the movement.

17. Using a #2 Phillips screwdriver remove the 4 indicated screws, and two additional screws on the far side, from the Motor Cover and remove it.

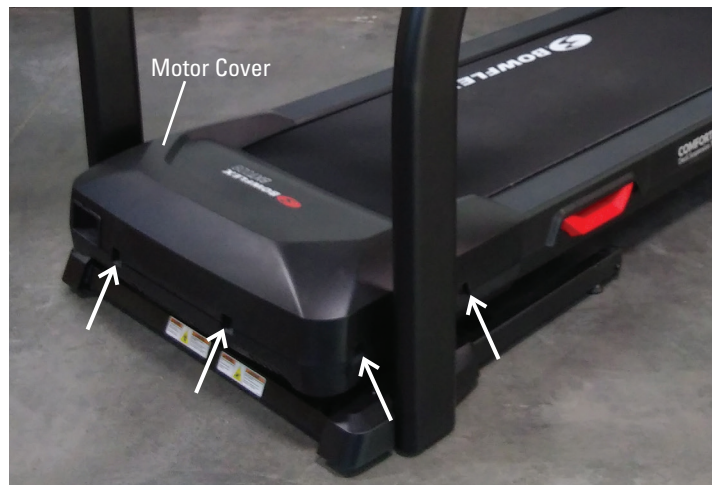



**Note:** Your machine may not match the provided images exactly.

18. Using a #2 Phillips screwdriver remove the 2 indicated screws from the MCB Cover and remove it.

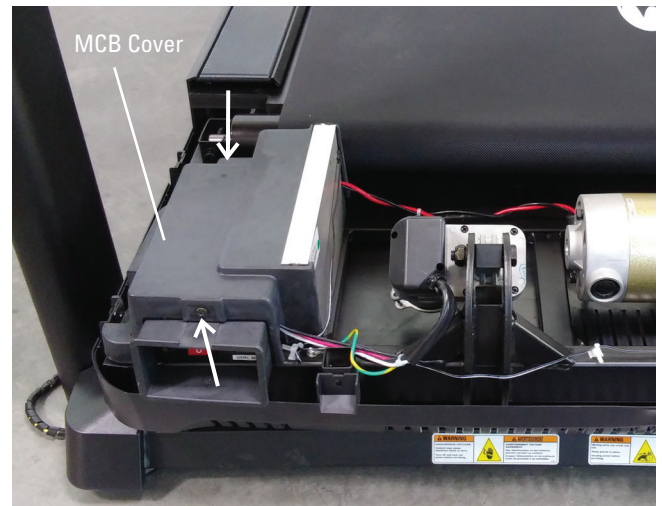

19. Be sure to observe the distance from the Speed Sensor to the Drive Pulley. This distance affects the effectiveness of the Speed Sensor, and can easily be shifted accidentally during replacement procedures.

20. Using a 6mm hex wrench, loosen the indicated screws on the Motor Mount.

21. Using a 13mm Open Ended Wrench, rotate the Belt Tensioner Screw enough to remove the Drive Belt from the Motor.

**Note:** To assist with reassembly, be sure to record the number of threads exposed before loosening.

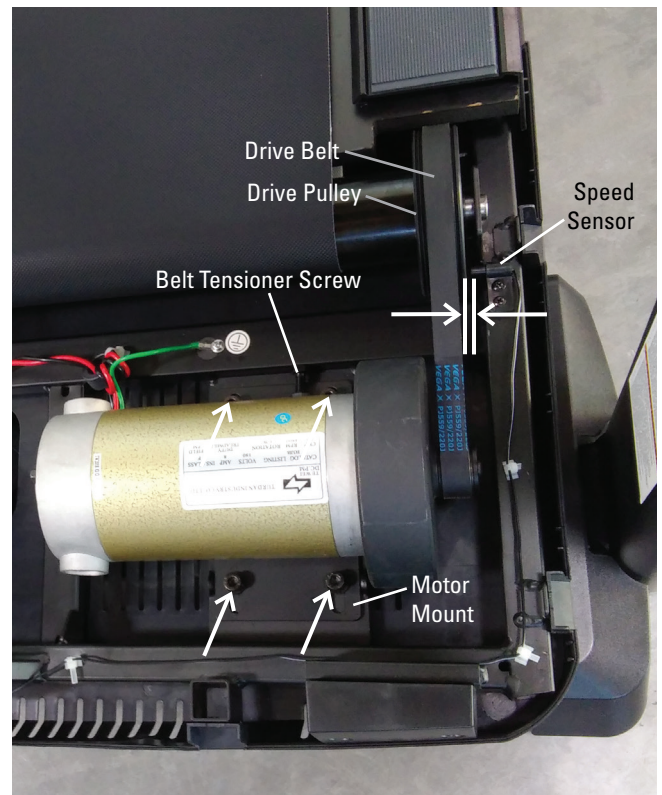

22. Using a 6mm hex wrench, remove the indicated screw from the Front Roller.

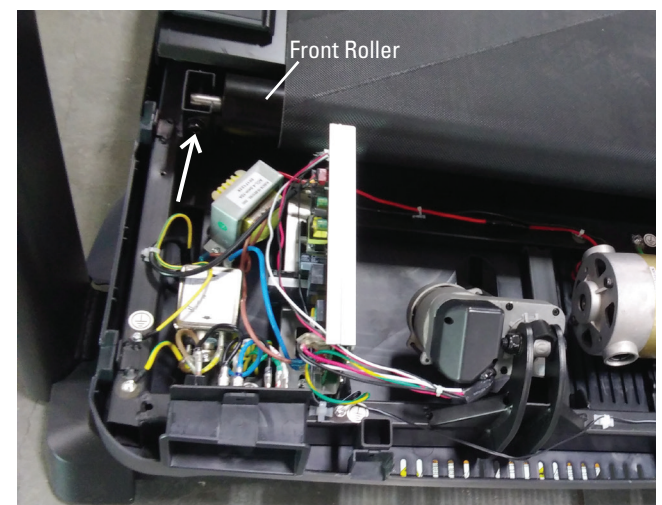

23. Using a 6mm hex wrench, remove the 2 indicated screws from the Deck.



24. Lift and pivot the Front Roller out of the Frame, and slide it out of the Walking Belt. This will free the Drive Belt from the Front Roller.

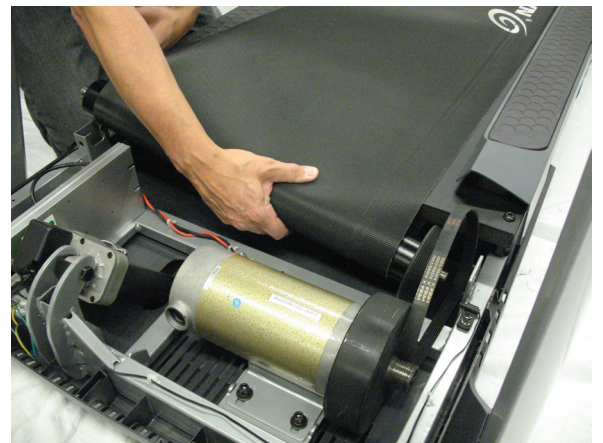

25. Using a 6mm hex wrench, finish removing the Adjustment Bolt from the Rear Roller.

**Note:** Be sure to record the number of turns of the Adjustment Bolt it takes to remove it. This will assist with reassembly.

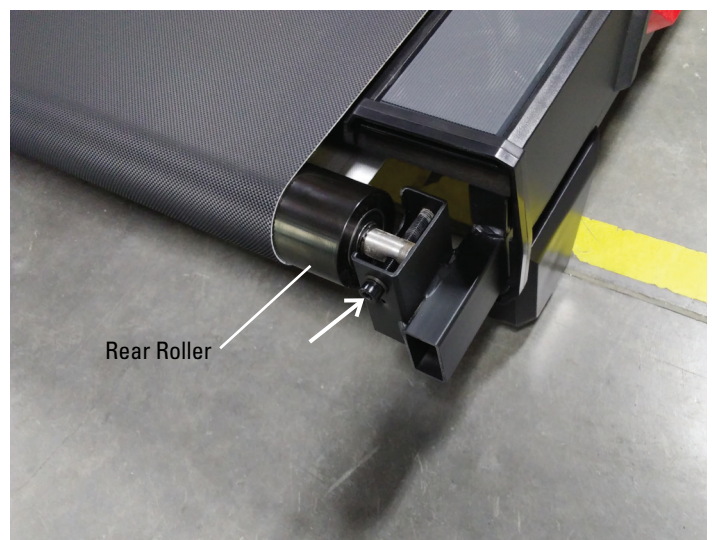



26. Slide the old Walking Belt off of the Deck, and replace with a new Walking Belt.

27. Slide the Front Roller into the new Walking Belt in the same orientation.

28. Using a 6mm hex wrench, re-attach the Adjustment Bolt to the Rear Roller.  
**Note:** Be sure to only tighten it the number of turns it took to loosen the Walking Belt.

29. Using a 6mm hex wrench, re-install the 2 screws to the Deck.

30. Loop the Drive Belt around the Front Roller. Insert the end of the Front Roller with the Drive Pulley into the Frame and pivot the other end into the Bracket.

31. Using a 6mm hex wrench, attach the Front Roller to the Bracket.  
**Note:** Tighten the hardware until the Front Roller is centered in the Bracket.

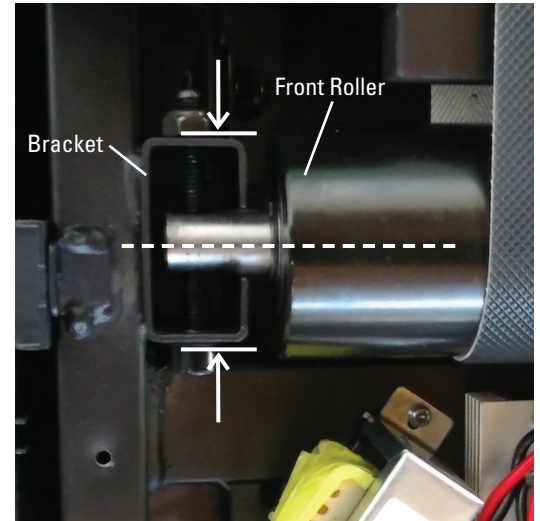
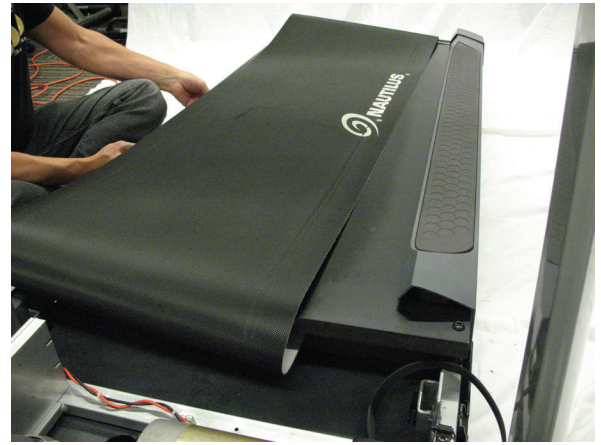

32. Loop the new Drive Belt around the Motor Pulley. Start the Drive Belt on the Drive Pulley and roll it in a clockwise motion. Be sure the Belt does not come off of the Motor Pulley.

 **Keep fingers out of any pinch opportunities when turning the Pulleys.**

33. Roll the Drive Pulley clockwise until the Drive Belt is fully installed. Continue to roll the Belt forward while adding side pressure with fingers to align as necessary.

34. With the Motor Assembly loosely attached to the Frame, turn the Belt Tensioner Screw to the previous level. This will tighten the Drive Belt to the previous tension level.

35. Using a 6mm hex wrench, fully tighten the screws that attach the Motor Mount to the Frame.

36. Inspect the Speed Sensor to see if it has been moved during the procedure. If necessary, adjust it to be the appropriate distance from the Drive Pulley.

37. Re-install all remaining parts that were removed in reverse order.

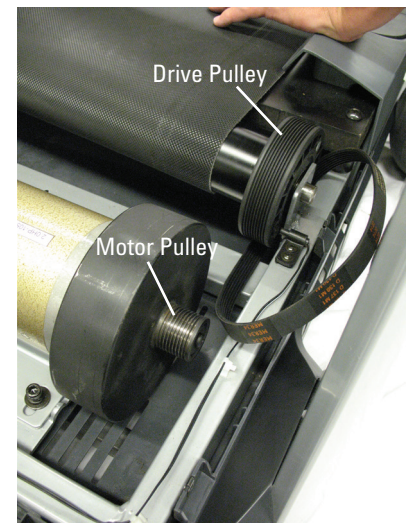

38. Inspect the surface material below the Treadmill. If the surface material is difficult to clean or could be damaged by silicone lubricant, place absorbent material (such as cardboard or newspaper) below the length of the Walking Deck.

39. Make sure that there is safe clearance around, on and above the treadmill. Make sure there is no object to spill or cause blockage from the fully folded position.

**⚠ Be sure there is adequate height clearance for the raised deck.**

40. Using the support bar found below the rear of the walking belt, lift the walking deck fully upward and engage the hydraulic lift. Be sure that the hydraulic lift is correctly locked in place. You will hear an audible click when the hydraulic lift shifts into the locked position.

**⚠ Use proper safety precautions and lifting techniques. Bend your knees and elbows, keep your back straight and pull up equally with both arms. Make sure that your own physical strength is capable of lifting the walking deck until it engages the locking mechanism. Use a second person if necessary. Do not use the walking belt or rear roller to lift the treadmill. These parts do not lock in place and can abruptly move. Injury to you or damage to the machine can occur.**

41. Make sure that the locking mechanism is engaged. Carefully pull back on the walking deck and make sure that it does not move. When you do this, keep clear of movement path in case the treadmill lock is not properly engaged.

**⚠ Do not lean against the treadmill when it is folded. Do not put items on it that could cause it to become unstable or fall.**

42. Apply a few drops of lubricant to the inner surface of the belt for the entire width of the belt. A very thin layer of silicone lubricant on the entire deck below the belt is desired.

*NOTICE:* Always use a 100% silicone lubricant. Do not use a degreaser like WD-40® as this could seriously impact performance. We can recommend that you use the following:

- 8300 Silicone Spray, available at most Hardware and Auto Parts stores.
- Lube-N-Walk® Treadmill Lubrication Kit, available from your local specialty fitness dealer or Nautilus, Inc.

43. Manually rotate the belt 1/2 of the length of the belt and apply lubricant again.

44. Make sure there is sufficient space to lower the walking deck.

**⚠ Keep a minimum clearance behind the machine of 79" (2 m) and 24" (0.6 m) on each side. This is the recommended safe distance for access, movement and emergency dismounts from the machine.**

45. Make sure there is no object on or around the treadmill to spill or cause blockage from the fully unfolded position.

46. Slightly push the walking deck forward toward the console. With your foot lightly push the top part of the hydraulic lift forward until the locking tube releases and you can pull the walking deck away from the console. Hold up the rear of the walking deck, and move to the side of the machine.





**!** Keep clear of the movement path of the walking deck.

47. The hydraulic lift is set up to drop gradually. Hold onto the walking deck until approximately 2/3 of the movement down. Lower the weight with your legs. Be aware that the walking deck can possibly drop quickly in the last part of the movement.

**!** If you used spray lubricant, wait 5 minutes before turning on power to the machine to allow the aerosol to dissipate.

48. Attach the power cord and turn on the Treadmill by flipping the power switch to ON.

49. Start the belt at the slowest speed and stand well behind the machine. Let the belt operate for approximately 15 seconds. Notice if the Walking Belt needs to be adjusted so it runs centered on the machine.

**!** Be sure not to touch the walking belt or step on the power cord. Keep bystanders, children and pets away from the machine you are servicing at all times.

50. If the Walking Belt needs to be adjusted, use a 6mm hex wrench on the side the belt should move away from and rotate the Adjustment Bolt a 1/4 turn clock-wise.

51. Allow the Walking Belt to adjust to the new tension by allowing it to run a couple seconds.

52. Repeat steps 50 and 51 until the Walking Belt is centered.

53. Switch off your machine.

54. Take care to clean up any excess lubricant from the deck.

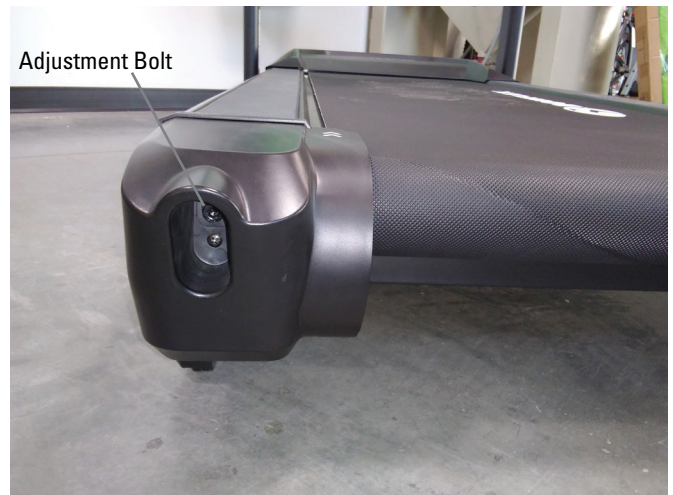

**!** To decrease the possibility of slipping, be sure the deck area is free from grease or oil. Clean off any excess oil from the machine surfaces.

55. Final Inspection

Inspect your machine to ensure that all hardware is tight and components are properly assembled.

**!** Do not use until the machine has been fully assembled and inspected for correct performance in accordance with the Owner's Manual.

**NOTICE:** This document provides instructions for the replacement of the Walking Deck on the Bowflex™ BXT6 / BXT028 Treadmill.

If you need assistance, please contact Customer Service (if purchased in US/Canada) or your local distributor (if purchased outside US/Canada). To find your local distributor, go to: [www.nautilusinternational.com](http://www.nautilusinternational.com)

 **This icon means a potentially hazardous situation which, if not avoided, could result in death or serious injury. Read and understand all Warnings on this machine.**

Nautilus, Inc., [www.NautilusInc.com](http://www.NautilusInc.com), 5415 Centerpoint Parkway, Groveport, OH 43125 U.S.A. - Customer Service: North America (800) 605-3369, [csnls@nautilus.com](mailto:csnls@nautilus.com) | outside U.S. [www.nautilusinternational.com](http://www.nautilusinternational.com) | Printed in China | © 2020 Nautilus, Inc. | Bowflex and the B logo are trademarks owned or licensed by Nautilus, Inc., registered or otherwise protected by common law in the United States and other nations. | **ORIGINAL DOCUMENT - ENGLISH VERSION ONLY**

### Important Safety Instructions - Before servicing or using this equipment, obey the following warnings:

 **This icon means a potentially hazardous situation which, if not avoided, could result in death or serious injury. Read and understand all Warnings on this machine.**

**⚠ DANGER** To reduce the risk of electrical shock or unsupervised usage of the equipment, always unplug the power cord from the wall outlet and wait 5 minutes before cleaning, maintaining or repairing this machine. Place the power cord in a secure location.

- Read and understand the Part Replacement Procedure before working on the machine. Failure to obey the instructions and safety warnings could cause injury to the service technician or bystanders.
- Keep bystanders, children and pets away from the product being serviced at all times.
- Make sure that the repair is done in an appropriate work space away from foot traffic and exposure to bystanders.
- Disconnect all power and allow to sit for 5 minutes before you service this machine.
- Some components of the equipment can be heavy or awkward. Enlist the service of a second person when you do maintenance steps involving these components. Do not try to do heavy or awkward steps on your own.
- If replacement parts are necessary, use only genuine Nautilus replacement parts and hardware. Failure to use genuine replacement parts can cause a risk to users, keep the machine from operating correctly and will void the warranty.
- Be sure that all warning stickers and instructional placards applied to the product stay present and in good condition when doing maintenance or replacing components. If at any time the Warning labels become loose, unreadable or dislodged, replace the labels. If purchased in US/Canada, contact Customer Service for replacement labels. If purchased outside US/Canada, contact your local distributor for them.
- Do not try to change the design or functionality of the machine being serviced as this can adversely effect user safety and will void the warranty.
- Do not use the machine until all shrouds, instructions, warning labels and correct functionality have been verified and tested for correct performance.

#### Tools Required (not included)

#2 Phillips screwdriver

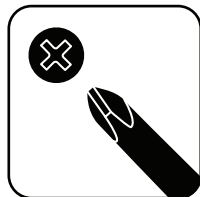

8300 Silicone Spray or Lube-N-Walk® Treadmill Lubrication Kit

6mm hex wrench



**⚠ DANGER** To reduce the risk of electrical shock or unsupervised usage of the equipment, always unplug the power cord from the wall outlet and wait 5 minutes before cleaning, maintaining or repairing this machine. Place the power cord in a secure location.

1. Unplug the power cord from the machine and wait 5 minutes. Place the power cord in a secure location.

2. Using a 6mm hex wrench, loosen the Walking Belt with the Adjustment Bolts found on both Rear Roller Covers. Loosen the Adjustment Bolts only until the Walking Belt slides past the Rollers freely. Do not loosen the Adjustment Bolts too much or the Rear Roller may detach.

**Note:** Be sure to record the number of turns of the Adjustment Bolts it takes to loosen the Walking Belt. This will assist with reassembly.

3. Using a #2 Phillips screwdriver, remove the indicated screw (with arrow) from the Rear Roller Cover.

4. Make sure that there is safe clearance around, on and above the treadmill. Make sure there is no object to spill or cause blockage from the fully folded position.

**⚠** Be sure there is adequate height clearance for the raised deck.

5. Using the support bar found below the rear of the walking belt, lift the walking deck fully upward and engage the hydraulic lift. Be sure that the hydraulic lift is correctly locked in place. You will hear an audible click when the hydraulic lift shifts into the locked position.

**⚠** Use proper safety precautions and lifting techniques. Bend your knees and elbows, keep your back straight and pull up equally with both arms. Make sure that your own physical strength is capable of lifting the walking deck until it engages the locking mechanism. Use a second person if necessary.

**Do not use the walking belt or rear roller to lift the treadmill. These parts do not lock in place and can abruptly move. Injury to you or damage to the machine can occur.**

6. Make sure that the locking mechanism is engaged. Carefully pull back on the walking deck and make sure that it does not move. When you do this, keep clear of movement path in case the treadmill lock is not properly engaged.

**⚠** Do not lean against the treadmill when it is folded. Do not put items on it that could cause it to become unstable or fall.

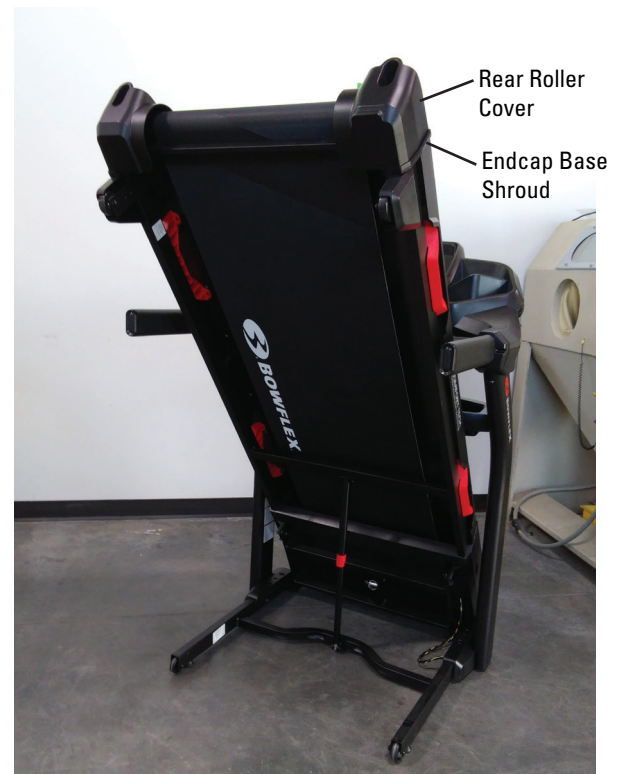
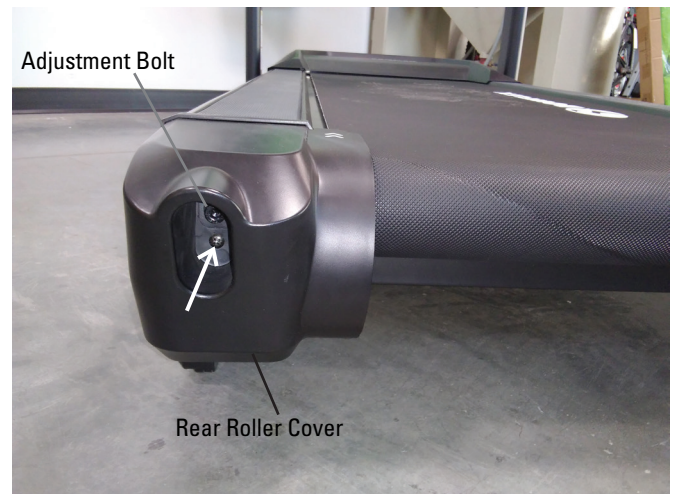
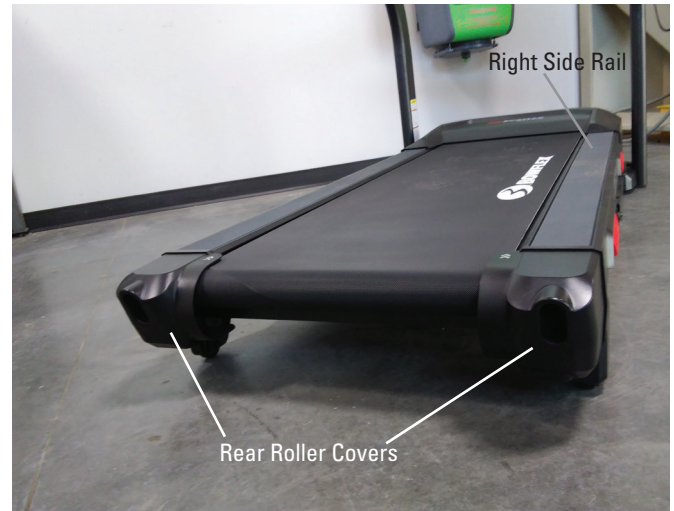



7. Using a #2 Phillips screwdriver, remove the indicated screw (with arrow) from the Rear Roller Cover.

8. Remove the Rear Roller Covers and Endcap Base Shrouds.

**Note:** To assist with reassembly, be sure to notice how the Endcap Base Shroud is secured by the Rear Roller Cover.

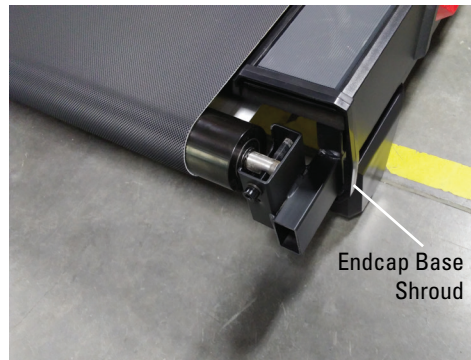

9. Using a #2 Phillips screwdriver, remove the 6 indicated screws from below the Walking Deck that attach the Right Side Rail.

10. Remove the Right Side Rail from the Walking Deck.





11. Using a #2 Phillips screwdriver remove the 4 indicated screws from the Right Deck Suspensions.

12. Remove the Right Deck Suspension.

13. Repeat the last six Steps on the other side of the machine.

14. Make sure there is sufficient space to lower the walking deck.

**!** Keep a minimum clearance behind the machine of 79" (2 m) and 24" (0.6 m) on each side. This is the recommended safe distance for access, movement and emergency dismounts from the machine.

15. Make sure there is no object on or around the treadmill to spill or cause blockage from the fully unfolded position.

16. Slightly push the walking deck forward toward the console. With your foot lightly push the top part of the hydraulic lift forward until the locking tube releases and you can pull the walking deck away from the console. Hold up the rear of the walking deck, and move to the side of the machine.

**!** Keep clear of the movement path of the walking deck.

17. The hydraulic lift is set up to drop gradually. Hold onto the walking deck until approximately 2/3 of the movement down. Lower the weight with your legs. Be aware that the walking deck can possibly drop quickly in the last part of the movement.

18. Using a #2 Phillips screwdriver remove the 4 indicated screws, and two additional screws on the far side, from the Motor Cover and remove it.

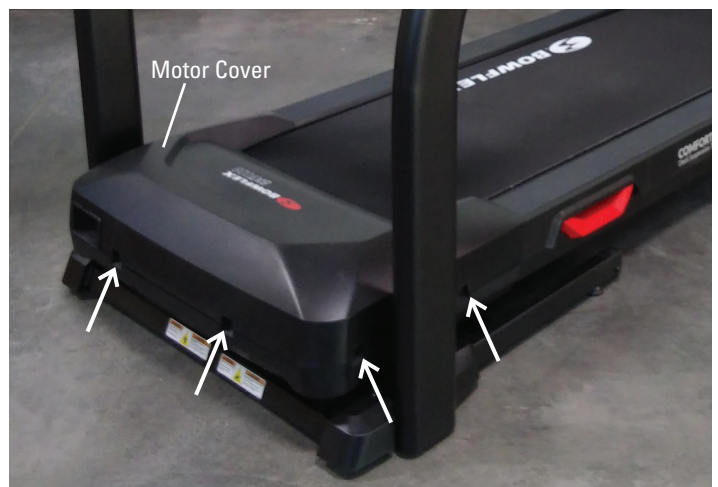

**Note:** Your machine may not match the provided images exactly.

19. Using a 6mm hex wrench, remove the 3 indicated screws from each side of the Walking Deck.



20. Slide the old Walking Deck Assembly out of the Walking Belt, and flip over so the Walking Belt Guides are exposed.

21. Using a #2 Phillips screwdriver, remove the Walking Belt Guides and attach them to the new Walking Deck as shown.

**Note:** The Walking Belt Guides must be attached to the new Walking Deck on the side with the Securing Tabs.

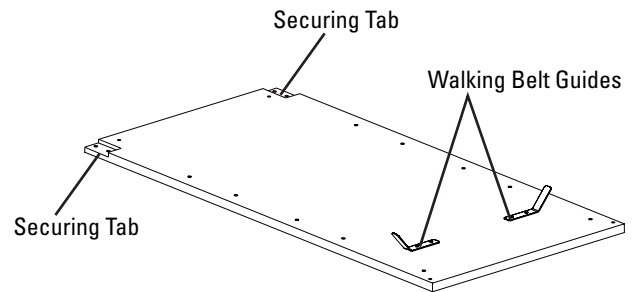

22. Turn over the new Walking Deck Assembly, and slide it between the Walking Belt with the Walking Belt Guides down and to the front of the machine.

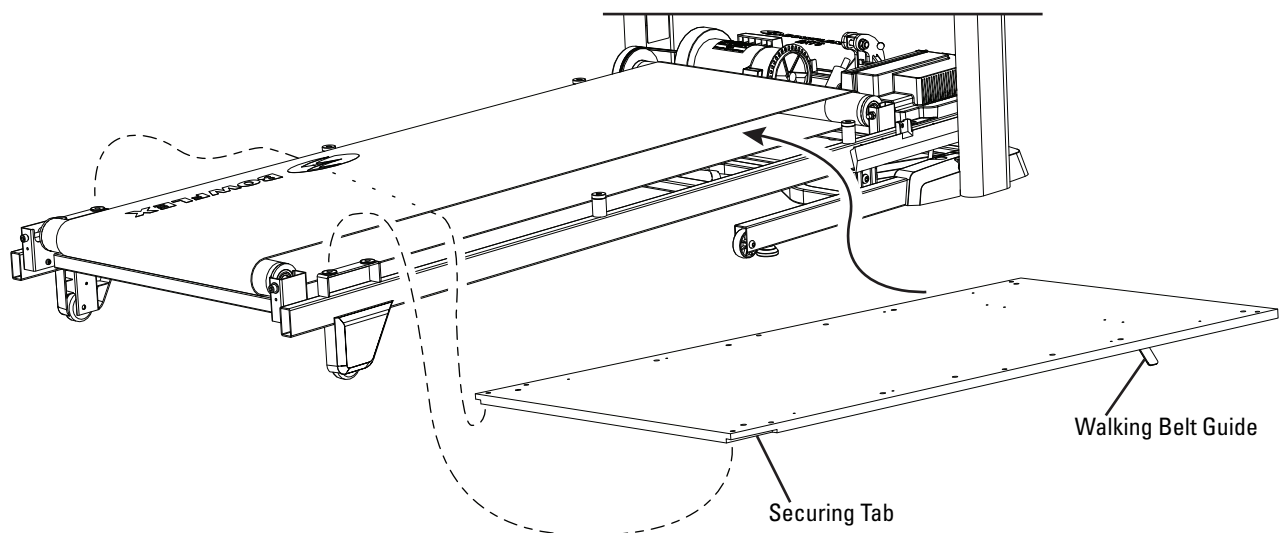

23. Using a 6mm hex wrench, re-install the 6 screws to the Deck.

24. Re-install all remaining parts that were removed in reverse order.

**Note:** Be sure to tighten the Adjustment Bolts to the recorded number of turns.

25. Inspect the surface material below the Treadmill. If the surface material is difficult to clean or could be damaged by silicone lubricant, place absorbent material (such as cardboard or newspaper) below the length of the Walking Deck.

26. Apply a few drops of the lubricant on the deck below the belt. Carefully lift the belt and apply a few drops of the lubricant the entire width of the belt. A very thin layer of silicone lubricant on the entire deck below the belt is desired.

**NOTICE:** Always use a 100% pure silicone lubricant. Do not use a degreaser like WD-40® as this could seriously impact performance. We can recommend that you use the following:

- 100% pure silicone, available at most hardware and auto parts stores.
- Lube-N-Walk® Treadmill Lubrication Kit, available from your local specialty fitness dealer or Nautilus, Inc.



**!** **Silicone lubricant is not intended for human consumption. Keep out of reach of children. Store in a safe place.**

27. Manually rotate the belt 1/2 of the length of the belt and apply lubricant again.

**!** **If you used spray lubricant, wait 5 minutes before turning on power to the machine to allow the aerosol to dissipate.**

28. Attach the power cord and turn on the Treadmill by flipping the power switch to ON.

29. Start the belt at the slowest speed and stand well behind the machine. Let the belt operate for approximately 15 seconds. Notice if the Walking Belt needs to be adjusted so it runs centered on the machine.

**!** **Be sure not to touch the walking belt or step on the power cord. Keep bystanders, children and pets away from the machine you are servicing at all times.**

30. If the Walking Belt needs to be adjusted, use a 6mm hex wrench on the side the belt should move away from and rotate the Adjustment Bolt a 1/4 turn clock-wise.

31. Allow the Walking Belt to adjust to the new tension by allowing it to run a couple seconds.

32. Repeat steps 30 and 31 until the Walking Belt is centered.

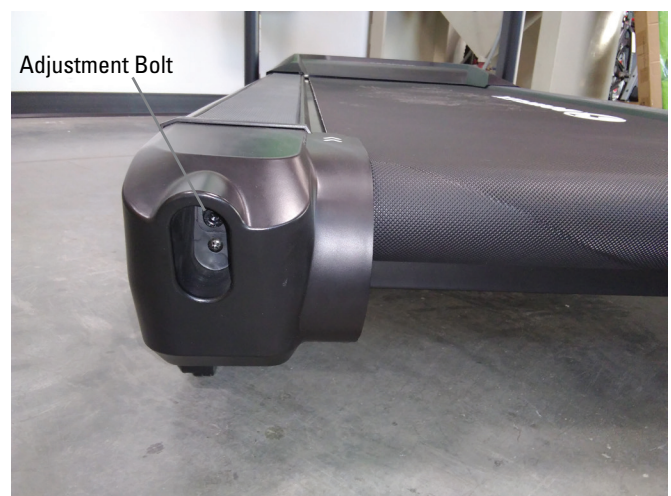

33. Switch off your machine.

34. Take care to clean up any excess lubricant from the deck.

 **To decrease the possibility of slipping, be sure the deck area is free from grease or oil. Clean off any excess oil from the machine surfaces.**

35. Final Inspection

Inspect your machine to ensure that all hardware is tight and components are properly assembled.

 **Do not use until the machine has been fully assembled and inspected for correct performance in accordance with the Owner's Manual.**



**NOTICE:** This document provides instructions for the installation of the Walking Deck Kit on the Bowflex™ BXT6 / BXT028 Treadmill.

If you need assistance, please contact Customer Service (if purchased in US/Canada) or your local distributor (if purchased outside US/Canada). To find your local distributor, go to: [www.nautilusinternational.com](http://www.nautilusinternational.com)

 **This icon means a potentially hazardous situation which, if not avoided, could result in death or serious injury. Read and understand all Warnings on this machine.**

Nautilus, Inc., [www.NautilusInc.com](http://www.NautilusInc.com), 5415 Centerpoint Parkway, Groveport, OH 43125 U.S.A. - Customer Service: North America (800) 605-3369, [csnls@nautilus.com](mailto:csnls@nautilus.com) | outside U.S. [www.nautilusinternational.com](http://www.nautilusinternational.com) | Printed in China | © 2020 Nautilus, Inc. | Bowflex and the B logo are trademarks owned or licensed by Nautilus, Inc., registered or otherwise protected by common law in the United States and other nations. | **ORIGINAL DOCUMENT**  
- ENGLISH VERSION ONLY

### Important Safety Instructions - Before servicing or using this equipment, obey the following warnings:

 **This icon means a potentially hazardous situation which, if not avoided, could result in death or serious injury. Read and understand all Warnings on this machine.**

**⚠ DANGER** To reduce the risk of electrical shock or unsupervised usage of the equipment, always unplug the power cord from the wall outlet and wait 5 minutes before cleaning, maintaining or repairing this machine. Place the power cord in a secure location.

- Read and understand the Part Replacement Procedure before working on the machine. Failure to obey the instructions and safety warnings could cause injury to the service technician or bystanders.
- Keep bystanders, children and pets away from the product being serviced at all times.
- Make sure that the repair is done in an appropriate work space away from foot traffic and exposure to bystanders.
- Disconnect all power and allow to sit for 5 minutes before you service this machine.
- Some components of the equipment can be heavy or awkward. Enlist the service of a second person when you do maintenance steps involving these components. Do not try to do heavy or awkward steps on your own.
- If replacement parts are necessary, use only genuine Nautilus replacement parts and hardware. Failure to use genuine replacement parts can cause a risk to users, keep the machine from operating correctly and will void the warranty.
- Be sure that all warning stickers and instructional placards applied to the product stay present and in good condition when doing maintenance or replacing components. If at any time the Warning labels become loose, unreadable or dislodged, replace the labels. If purchased in US/Canada, contact Customer Service for replacement labels. If purchased outside US/Canada, contact your local distributor for them.
- Do not try to change the design or functionality of the machine being serviced as this can adversely effect user safety and will void the warranty.
- Do not use the machine until all shrouds, instructions, warning labels and correct functionality have been verified and tested for correct performance.

### Tools Required (not included)

#2 Phillips screwdriver

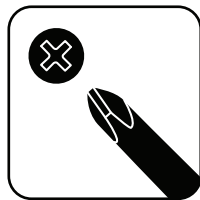

8300 Silicone Spray or Lube-N-Walk® Treadmill Lubrication Kit

6mm hex wrench



**⚠ DANGER** To reduce the risk of electrical shock or unsupervised usage of the equipment, always unplug the power cord from the wall outlet and wait 5 minutes before cleaning, maintaining or repairing this machine. Place the power cord in a secure location.

1. Unplug the power cord from the machine and wait 5 minutes. Place the power cord in a secure location.

2. Using a 6mm hex wrench, loosen the Walking Belt with the Adjustment Bolts found on both Rear Roller Covers. Loosen the Adjustment Bolts only until the Walking Belt slides past the Rollers freely. Do not loosen the Adjustment Bolts too much or the Rear Roller may detach.

**Note:** Be sure to record the number of turns of the Adjustment Bolts it takes to loosen the Walking Belt. This will assist with reassembly.

3. Using a #2 Phillips screwdriver, remove the indicated screw (with arrow) from the Rear Roller Cover.

4. Make sure that there is safe clearance around, on and above the treadmill. Make sure there is no object to spill or cause blockage from the fully folded position.

**⚠** Be sure there is adequate height clearance for the raised deck.

5. Using the support bar found below the rear of the walking belt, lift the walking deck fully upward and engage the hydraulic lift. Be sure that the hydraulic lift is correctly locked in place. You will hear an audible click when the hydraulic lift shifts into the locked position.

**⚠** Use proper safety precautions and lifting techniques. Bend your knees and elbows, keep your back straight and pull up equally with both arms. Make sure that your own physical strength is capable of lifting the walking deck until it engages the locking mechanism. Use a second person if necessary.

**Do not use the walking belt or rear roller to lift the treadmill. These parts do not lock in place and can abruptly move. Injury to you or damage to the machine can occur.**

6. Make sure that the locking mechanism is engaged. Carefully pull back on the walking deck and make sure that it does not move. When you do this, keep clear of movement path in case the treadmill lock is not properly engaged.

**⚠** Do not lean against the treadmill when it is folded. Do not put items on it that could cause it to become unstable or fall.

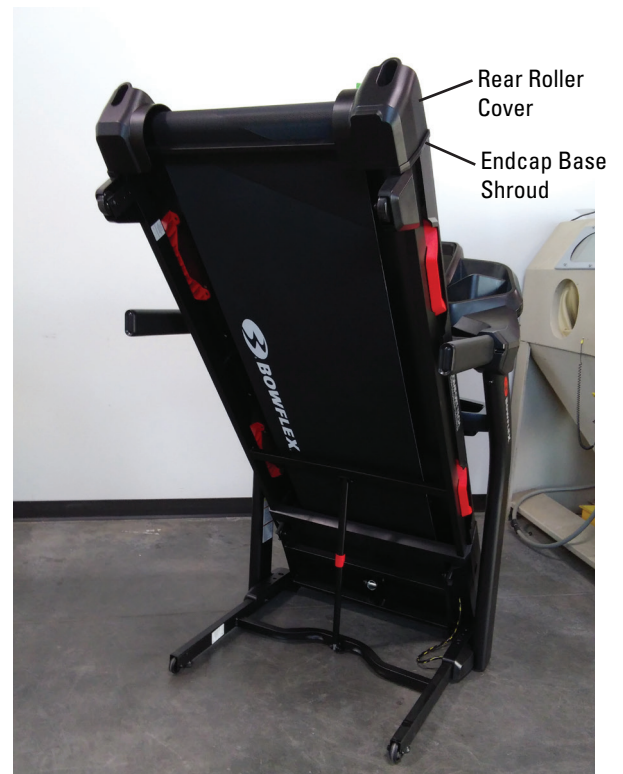
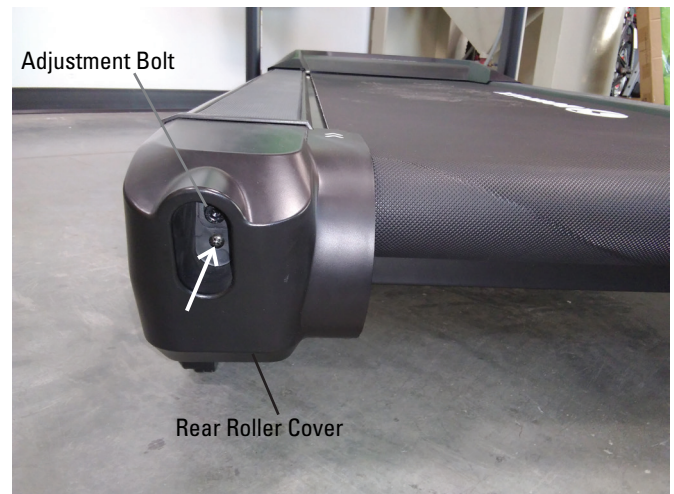
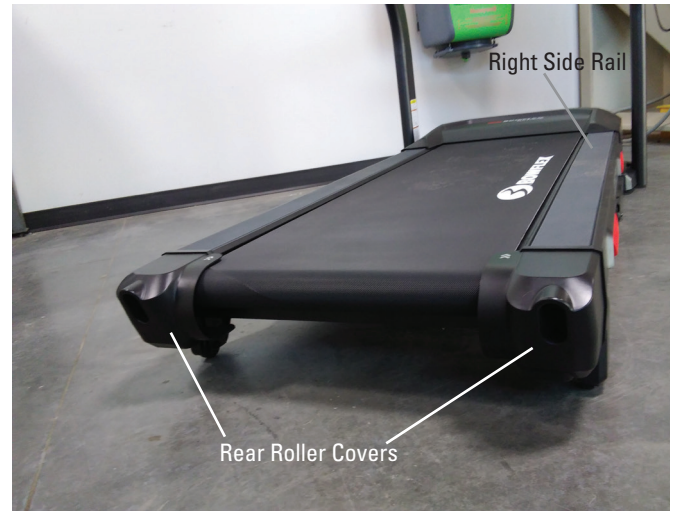

7. Using a #2 Phillips screwdriver, remove the indicated screw (with arrow) from the Rear Roller Cover.

8. Remove the Rear Roller Covers and Endcap Base Shrouds.

**Note:** To assist with reassembly, be sure to notice how the Endcap Base Shroud is secured by the Rear Roller Cover.

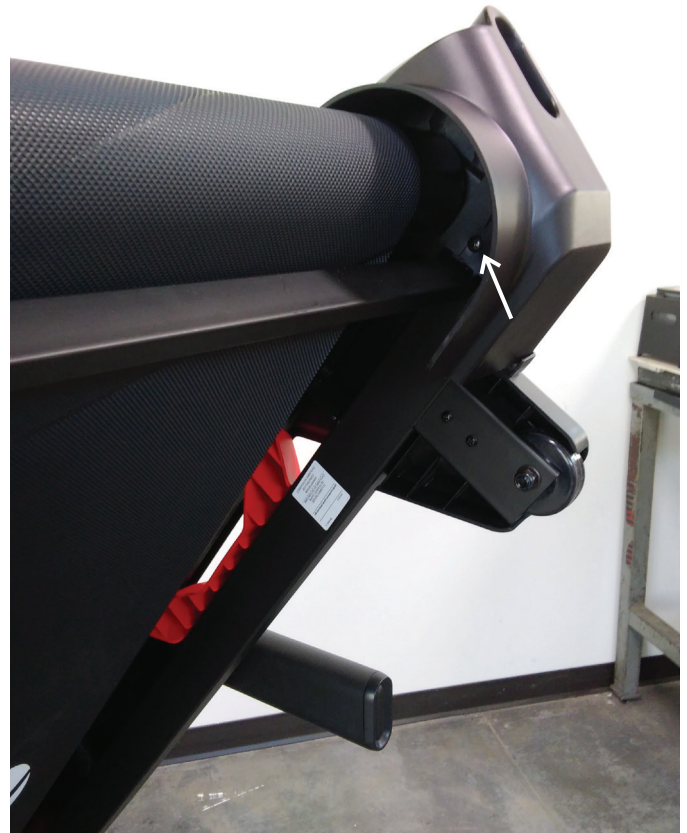
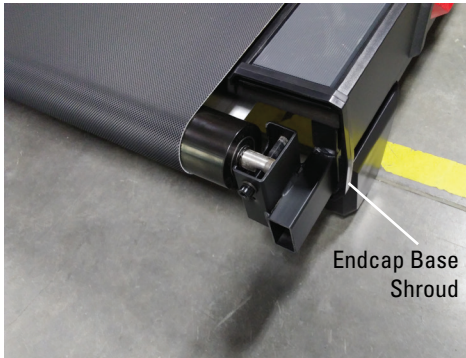

9. Using a #2 Phillips screwdriver, remove the 6 indicated screws from below the Walking Deck that attach the Right Side Rail.

10. Remove the Right Side Rail from the Walking Deck.





11. Using a #2 Phillips screwdriver remove the 4 indicated screws from the Right Deck Suspensions.

12. Remove the Right Deck Suspension and dispose of them.

**Note:** During re-assembly, be sure to use the provided new Deck Suspension.

13. Repeat the last six Steps on the other side of the machine.

14. Make sure there is sufficient space to lower the walking deck.

**!** Keep a minimum clearance behind the machine of 79" (2 m) and 24" (0.6 m) on each side. This is the recommended safe distance for access, movement and emergency dismounts from the machine.

15. Make sure there is no object on or around the treadmill to spill or cause blockage from the fully unfolded position.

16. Slightly push the walking deck forward toward the console. With your foot lightly push the top part of the hydraulic lift forward until the locking tube releases and you can pull the walking deck away from the console. Hold up the rear of the walking deck, and move to the side of the machine.

**!** Keep clear of the movement path of the walking deck.

17. The hydraulic lift is set up to drop gradually. Hold onto the walking deck until approximately 2/3 of the movement down. Lower the weight with your legs. Be aware that the walking deck can possibly drop quickly in the last part of the movement.

18. Using a #2 Phillips screwdriver remove the 4 indicated screws, and two additional screws on the far side, from the Motor Cover and remove it.

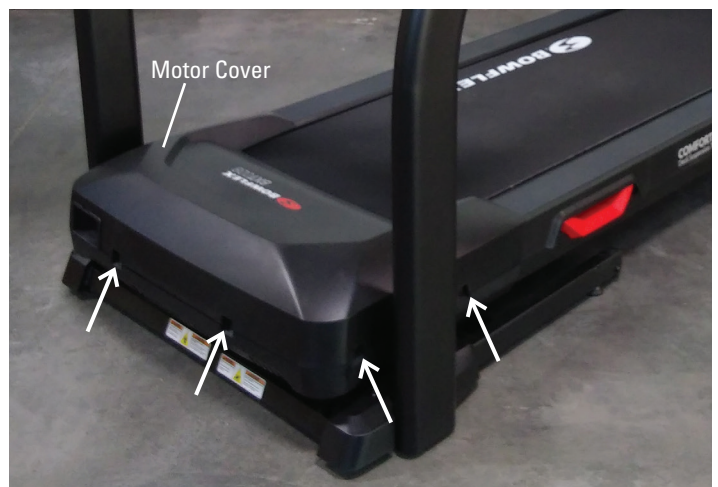



**Note:** Your machine may not match the provided images exactly.

19. Using a 6mm hex wrench, remove the 4 indicated screws from each side of the Walking Deck.



20. Slide the old Walking Deck Assembly out of the Walking Belt, and flip over so the Walking Belt Guides are exposed.

21. Using a #2 Phillips screwdriver, remove the Walking Belt Guides and attach them to the new Walking Deck as shown.

**Note:** The Walking Belt Guides must be attached to the new Walking Deck on the side with the Securing Tabs.

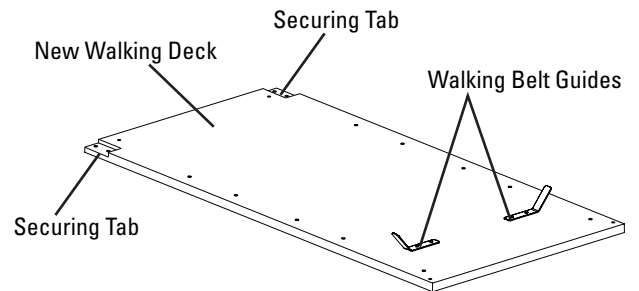

22. Turn over the new Walking Deck Assembly, and slide it between the Walking Belt with the Walking Belt Guides down and to the front of the machine.

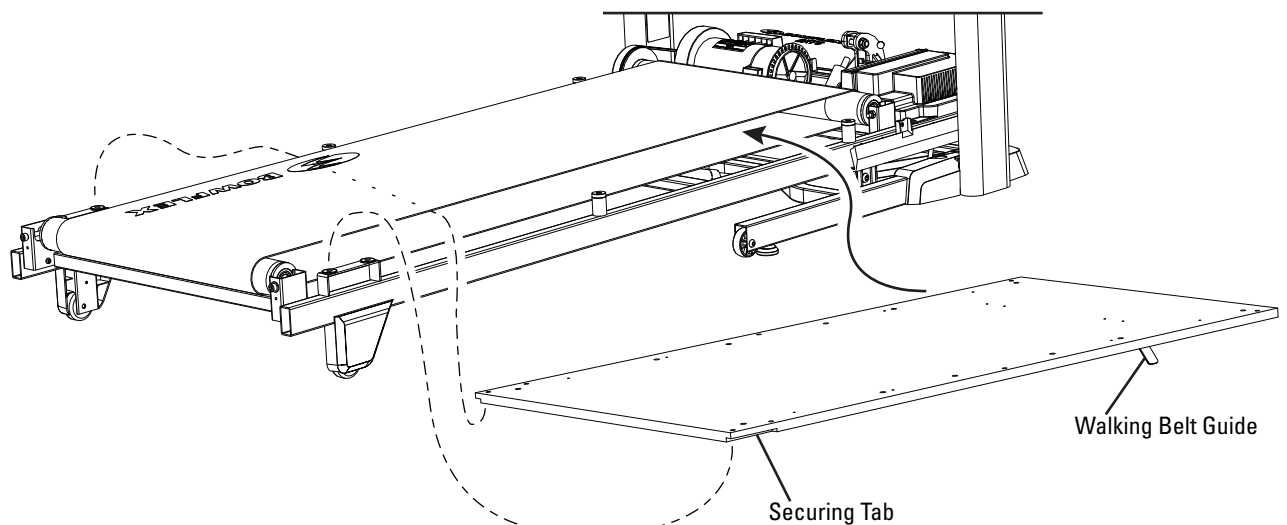

23. Using a 6mm hex wrench, install the 6 screws to the new Walking Deck.

24. Re-install all remaining parts that were removed in reverse order. Be sure to install all of the provided new Deck Suspensions and hardware.

**Note:** Be sure to tighten the Adjustment Bolts to the recorded number of turns.

25. Inspect the surface material below the Treadmill. If the surface material is difficult to clean or could be damaged by silicone lubricant, place absorbent material (such as cardboard or newspaper) below the length of the Walking Deck.

26. Apply a few drops of the lubricant on the deck below the belt. Carefully lift the belt and apply a few drops of the lubricant the entire width of the belt. A very thin layer of silicone lubricant on the entire deck below the belt is desired.

**NOTICE:** Always use a 100% pure silicone lubricant. Do not use a degreaser like WD-40® as this could seriously impact performance. We can recommend that you use the following:

- 100% pure silicone, available at most hardware and auto parts stores.
- Lube-N-Walk® Treadmill Lubrication Kit, available from your local specialty fitness dealer or Nautilus, Inc.

**!** **Silicone lubricant is not intended for human consumption. Keep out of reach of children. Store in a safe place.**

27. Manually rotate the belt 1/2 of the length of the belt and apply lubricant again.

**!** **If you used spray lubricant, wait 5 minutes before turning on power to the machine to allow the aerosol to dissipate.**

28. Attach the power cord and turn on the Treadmill by flipping the power switch to ON.

29. Start the belt at the slowest speed and stand well behind the machine. Let the belt operate for approximately 15 seconds. Notice if the Walking Belt needs to be adjusted so it runs centered on the machine.

**!** **Be sure not to touch the walking belt or step on the power cord. Keep bystanders, children and pets away from the machine you are servicing at all times.**

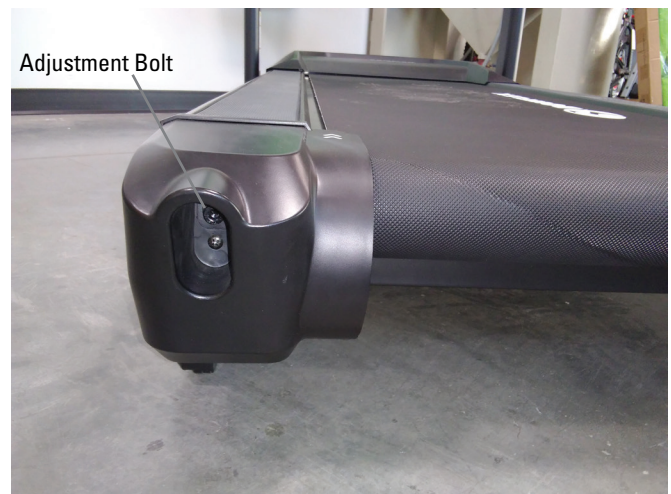

30. If the Walking Belt needs to be adjusted, use a 6mm hex wrench on the side the belt should move away from and rotate the Adjustment Bolt a 1/4 turn clock-wise.

31. Allow the Walking Belt to adjust to the new tension by allowing it to run a couple seconds.

32. Repeat steps 30 and 31 until the Walking Belt is centered.

33. Switch off your machine.

34. Take care to clean up any excess lubricant from the deck.

 **To decrease the possibility of slipping, be sure the deck area is free from grease or oil. Clean off any excess oil from the machine surfaces.**

35. Final Inspection

Inspect your machine to ensure that all hardware is tight and components are properly assembled.

 **Do not use until the machine has been fully assembled and inspected for correct performance in accordance with the Owner's Manual.**

**NOTICE:** This document provides instructions to update the firmware on the Bowflex™ BXT6 / BXT028 Treadmill.

If you need assistance, please contact Customer Service (if purchased in US/Canada) or your local distributor (if purchased outside US/Canada). To find your local distributor, go to: [www.nautilusinternational.com](http://www.nautilusinternational.com)

 This icon means a potentially hazardous situation which, if not avoided, could result in death or serious injury. Read and understand all Warnings on this machine.

Nautilus, Inc., [www.NautilusInc.com](http://www.NautilusInc.com), 5415 Centerpoint Parkway, Groveport, OH 43125 U.S.A. - Customer Service: North America (800) 605-3369, [csnls@nautilus.com](mailto:csnls@nautilus.com) | outside U.S. [www.nautilusinternational.com](http://www.nautilusinternational.com) | Printed in China | © 2020 Nautilus, Inc. | Bowflex and the B logo are trademarks owned or licensed by Nautilus, Inc., registered or otherwise protected by common law in the United States and other nations. | **ORIGINAL DOCUMENT - ENGLISH VERSION ONLY**

## Important Safety Instructions - Before servicing or using this equipment, obey the following warnings:

 This icon means a potentially hazardous situation which, if not avoided, could result in death or serious injury. Read and understand all Warnings on this machine.

- Read and understand the Part Replacement Procedure before working on the machine. Failure to obey the instructions and safety warnings could cause injury to the service technician or bystanders.
- Keep bystanders, children and pets away from the product being serviced at all times.
- Make sure that the repair is done in an appropriate work space away from foot traffic and exposure to bystanders.
- Some components of the equipment can be heavy or awkward. Enlist the service of a second person when you do maintenance steps involving these components. Do not try to do heavy or awkward steps on your own.
- If replacement parts are necessary, use only genuine Nautilus replacement parts and hardware. Failure to use genuine replacement parts can cause a risk to users, keep the machine from operating correctly and will void the warranty.
- Be sure that all warning stickers and instructional placards applied to the product stay present and in good condition when doing maintenance or replacing components. If at any time the Warning labels become loose, unreadable or dislodged, replace the labels. If purchased in US/Canada, contact Customer Service for replacement labels. If purchased outside US/Canada, contact your local distributor for them.
- Do not try to change the design or functionality of the machine being serviced as this can adversely effect user safety and will void the warranty.
- Do not use the machine until all shrouds, instructions, warning labels and correct functionality have been verified and tested for correct performance.

The following procedure should only be applied to a fully assembled and inspected machine for correct performance in accordance with the Owner's Manual.

1. Turn off the power supplied to the machine by flipping the Power Switch to Off at the front of the machine, and unplug the Power Cord from the machine.

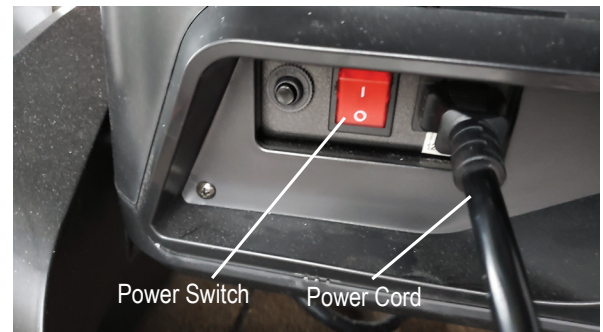

2. Locate the USB Port on the top of Console, and insert the provided USB Flash Drive into it.





3. Plug in the Power Cord to the machine, and flip the Power Switch to On. This will power up the machine.



4. The Console will be blank during the update process. Near the end of the update, the Console will briefly flash all of the display segments.

**Note:** If the Console does not automatically begin the update process, then the Console already has the same version of Firmware.



5. When the Console displays the "MANUAL" workout, the update is complete.
6. Flip the Power Switch to Off, and remove the USB Flash Drive from the Console.
7. Flip the Power Switch to On. This will power up the machine.
8. The machine is now ready to use.

