



Bowflex® BodyTower™



Owner's Manual

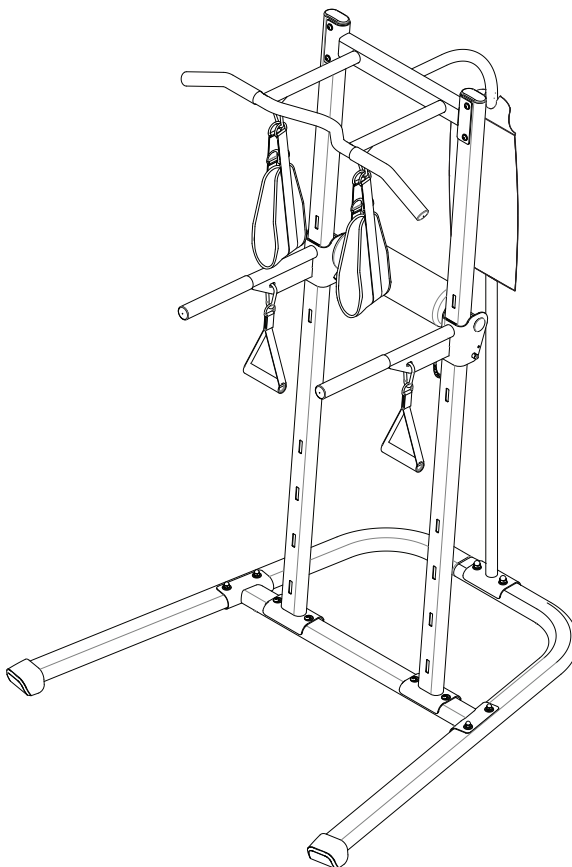

Table of Contents

| | |
|---|----|
| Important Safety Instructions | 3 |
| Safety Warning Labels and Serial Number | 4 |
| Specifications..... | 5 |
| Features | 6 |
| Operation..... | 7 |
| Workouts | 8 |
| Exercises | 11 |
| Muscle Chart | 21 |
| Maintenance..... | 22 |

To validate warranty support, keep the original proof of purchase and record the following information:

Serial Number _____

Date of Purchase _____

To register your product warranty, go to: **www.bowflex.com/register**
Or call 1 (800) 605–3369.

If you have questions or problems with your product, please call 1 (800) 605–3369.

Nautilus, Inc., (800) NAUTILUS / (800) 628-8458, www.NautilusInc.com - Customer Service: North America (800) 605-3369, csnls@nautilus.com | outside U.S. www.nautilusinternational.com | Printed in China | © 2011 Nautilus, Inc., All rights reserved. ® indicates trademarks registered in the United States. These marks may be registered in other nations or otherwise protected by common law. Bowflex, the B logo, BodyTower, Nautilus, Schwinn, and Universal are trademarks owned by or licensed to Nautilus, Inc.

Important Safety Instructions

 **This icon means a potentially hazardous situation which, if not avoided, could result in death or serious injury.**

Before using this equipment, obey the following warnings:

 **Read and understand the complete Owner's Manual. Keep Owner's Manual for future reference.**

Read and understand all warnings on this machine. If at any time the Warning stickers become loose, unreadable or dislodged, contact Nautilus Customer Service for replacement stickers.

- Children must not be let on or near to this machine. Moving parts and other features of the machine can be dangerous to children.
- Not intended for use by anyone under 14 years of age.
- Consult a physician before you start an exercise program. Stop exercising if you feel pain or tightness in your chest, become short of breath, or feel faint. Contact your doctor before you use the machine again.
- Before each use, examine this machine for loose parts or signs of wear. Inspect all straps and connections, making sure they are properly secured and attached, and show no signs of visible wear or damage. Contact Nautilus Customer Service for repair information.
- Maximum user weight limit: 300 lb. (136 kg). Do not use if you are over this weight.
- This machine is for home use only. Do not use in a commercial setting.
- Do not wear loose clothing or jewelry. This machine contains moving parts. Do not put fingers or other objects into moving parts of the exercise equipment.
- Always wear rubber soled athletic shoes when you use this machine. Do not use the machine with bare feet or only wearing socks.
- Set up and operate this machine on a solid, level, horizontal surface.
- Do not operate this machine outdoors or in moist or wet locations.
- Keep at least 36" (0.9m) on each side of the machine clear. This is the recommended safe distance for access and passage around and emergency dismounts from the machine. Keep third parties out of this space when machine is in use.
- Only exercise within the safe area shown by the limit labels on the base of the machine.
- Do not over exert yourself during exercise. Operate the machine in the manner described in this manual.

Safety Warning Labels and Serial Number

- Correctly adjust and safely engage all Positional Adjustment Devices. Make sure that the Adjustment Devices do not hit the user.

Safety Warning Labels and Serial Number

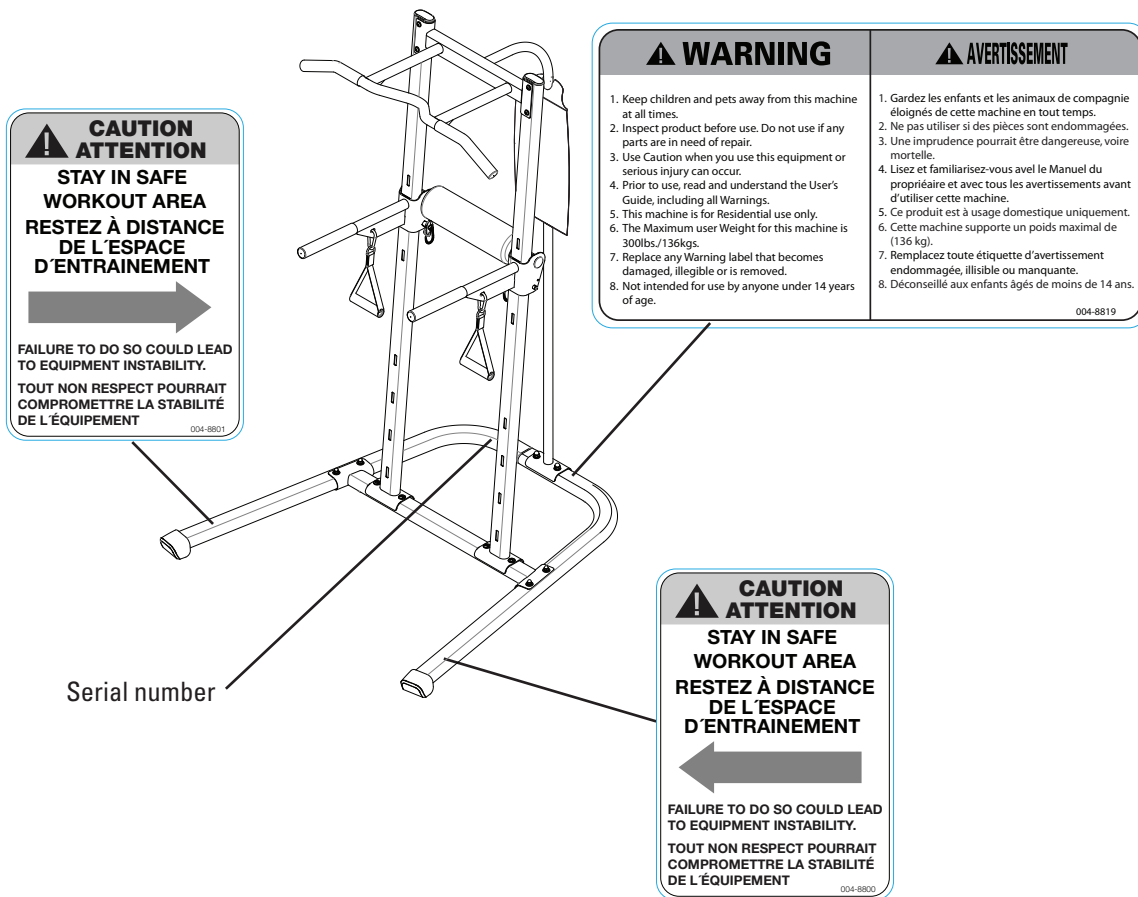

Note: Record serial number in the Serial Number field at the beginning of this manual.

Specifications

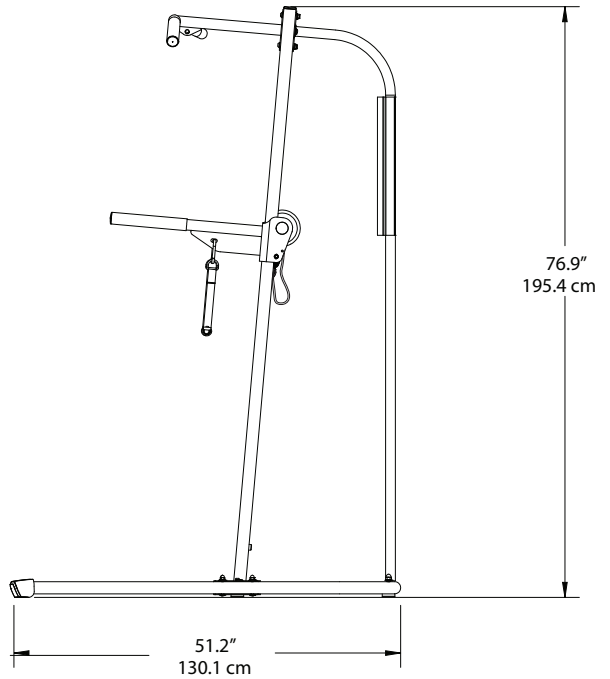
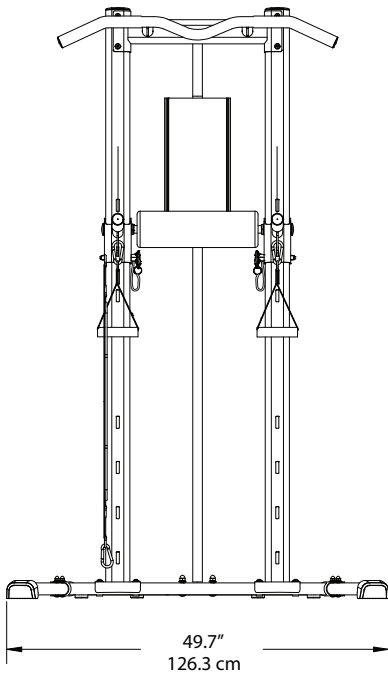

Max user weight 300 lbs. (136 kg)

This product complies with the following standards:

ASTM F2276-05

ASTM F2216-05

Features

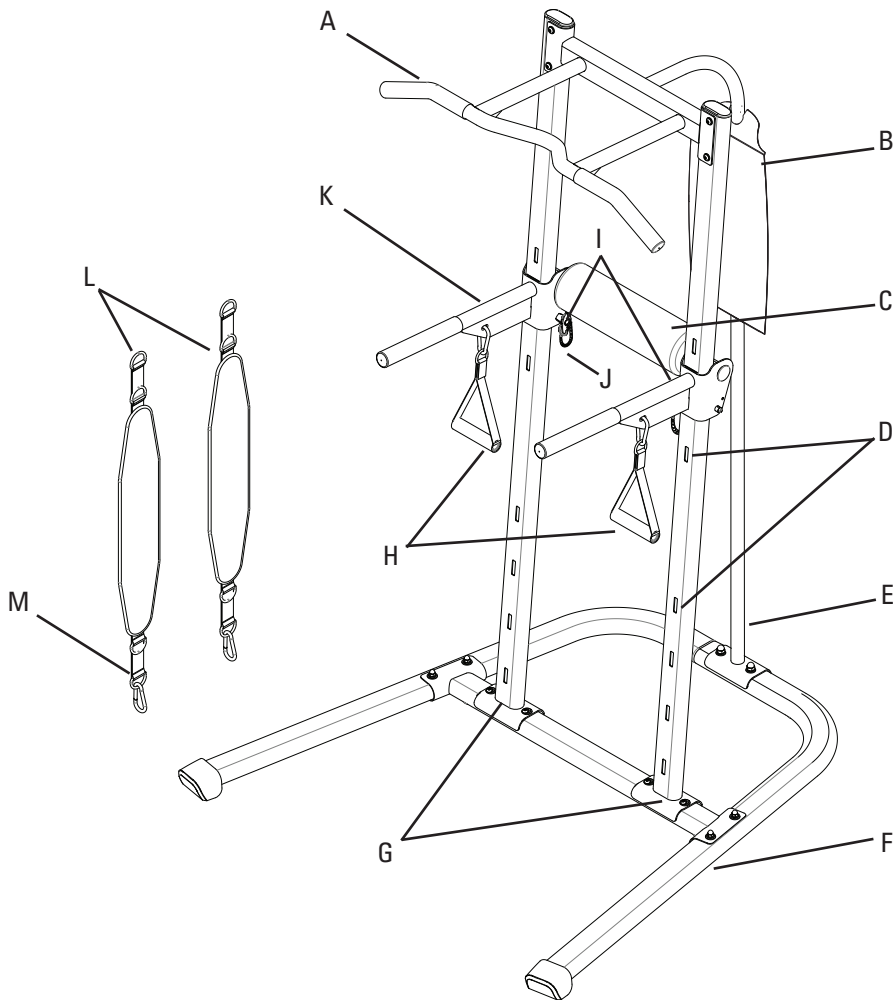

| | | | |
|---|-------------------------|---|---------------------|
| A | Pull Up Bar | H | Handgrips |
| B | Exercise Placard | I | Locking Pins |
| C | Back Pad | J | Locking Pin Tethers |
| D | Height Adjustment Holes | K | E-Z Adjust Bar |
| E | Backbone | L | Sling Straps |
| F | Base | M | Snaphooks |
| G | Uprights | | |

Operation

Pull Up Bar

The Pull Up Bar provides multiple grip positions for variety in the exercises.

E-Z Adjust Bar Assembly

To move the E-Z Adjust Bar Assembly, remove the locking pins from both side brackets. Carefully tilt the assembly, and raise or lower it to the desired position.

NOTICE: Be careful to avoid damage to the plastic sliders inside the E-Z Adjust arm brackets.

Engage the locking mechanism fully in the height adjustment holes in the uprights. Insert the locking pins in the holes in the side brackets.

⚠ Make sure that the E-Z Adjust Bar Assembly is locked in position with the locking pins before you start to exercise.

Sling Straps

The D-rings on the Sling Straps allow easy adjustment to different lengths. Attach one sling strap to each side of the Pull Up Bar. Be sure the foam padding on each strap is folded to the inside, and attach the snaphook to the D-ring and the hole in the Pull Up support arm.

⚠ Make sure that the Sling Straps are safely attached before you put your full weight on them.

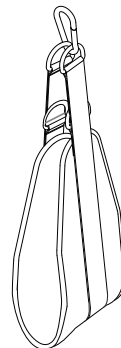

Handgrips

Attach the Handgrips to the arms of the E-Z Adjust Bar Assembly. Put the snaphook through the adjustment hole in the E-Z Adjust arm.

⚠ Make sure that the Handgrips are safely attached before you put your full weight on them.

Exercise Placard

The Exercise Placard attaches to the backbone for easy reference during workouts. It shows the basic set of exercises. Additional instructions for exercises are provided in this manual.

Workouts

Define Your Goals

Your body will do what you train it to do. That's why it's important to define your goals and focus them. Here are some fitness components that will help you define your goals and choose your fitness program.

Muscle Strength is the maximum force that you can exert against resistance at one time. Your muscle strength comes into play when you pick up a heavy bag of groceries or lift a small child. It is developed when a localized muscle is worked both positively (concentric) and negatively (eccentric) at a resistance – great enough so you can perform only five to eight repetitions of the exercise before the muscle fails. Each set of repetitions is followed by a rest interval that typically runs three times longer than the set. Later, between exercise sessions, the muscle overcompensates for the stress and usually increases in both strength and size.

Muscle Endurance is the ability to perform repeated contractions. It comes into play when you cross-country ski or work on your feet all day. Endurance training addresses the slow twitch, endurance muscle fibers, which depend on oxygen for energy. To develop muscle endurance, use low resistance and high repetitions – about 15-20 repetitions in each set, three sets to each exercise, working the muscle only to fatigue.

Muscle Power is the combination of strength and speed of the muscular contraction. This is often misinterpreted as A) being directly associated with certain skill or sport and/or B) meaning that you must move fast. Load is actually a more important factor than speed when attempting to improve power. When training to achieve muscular power, pick a resistance that fatigues you in the 3-5 repetition range. When performing these reps, it is more important to think of contracting the muscles faster rather than attempting to move faster. Performing sport simulation exercises usually results in a deterioration of the motor pattern or skill. The biomechanically sound method of improving power in your sport is to train for power using the correct joint movements, as described in this manual. Then practice the skill associated with your sport, learning to apply this newly achieved power.

Body Composition is the ratio of fat weight (fat) to lean weight (muscles, bones and tissue). As you age, the ratio shifts. The fat weight increases and the lean weight decreases. Training for muscle strength will generally increase muscle size and aerobic conditioning will help burn extra calories. Performing these two forms of exercise, either at different times or together, will create the greatest changes in body fat weight.

Balanced Strength and alignment are the result of equal strength developed in all parts of the body. It comes into play in your standing and sitting posture, and in your ability to perform just about any activity safely and effectively. An over-development of the back will round the shoulders; weak or stretched abdominals can cause lower back pain. You want a balance of

Workouts

muscle strength in front and back. In addition, you need a balance of strength between your middle, lower and upper body.

Flexibility is the ability of a muscle or group of muscles to move the joint through a full range of motion. Flexibility comes into play when you execute an overhand serve or stretch for the top shelf in the kitchen. It is a cooperative movement of opposite muscle groups. When a muscle contracts, its opposite muscle group must relax for the action to occur. Increased flexibility means an increased range of motion, made possible by this simultaneous contracting and relaxing. Good flexibility is important in protecting the body from injury and can be achieved through the balanced strength training programs that are included in this manual.

Cardiovascular Endurance is the ability of the heart and lungs to supply oxygen and nutrients to exercising muscles over an extended period of time. It comes into play when you jog a mile or ride a bike. It is a critical component of overall fitness and health. You may want to design your own personal program specifically geared to your goals and lifestyle. Designing a program is easy, as long as you follow the below guidelines.

Design Your Own Program

Understand fitness and its components. Improperly designed programs can be dangerous. Take some time to review this manual as well as other fitness guides.

Know your current fitness level. Before you start any fitness program you should consult a physician who will help you determine your current abilities.

Identify your goals. Goals are critical to choosing and designing an exercise program that fits and enhances your lifestyle, but so is strategy. It's important not to rush the process and try to accomplish too much too soon. That will lead to setbacks and discouragement. Instead, set a series of smaller achievable goals.

Select complementary exercises. Be sure to pair exercises that address compound joint movements and single joint movements. In addition, select exercises that address complementary muscle groups.

Put first things first. During each session, first work muscle groups that need the most training. Remember your cardiovascular component. Any fitness program must contain a cardiovascular fitness component to be complete.

So complement your resistance training with aerobic exercise such as walking, running, or bicycling.

Workouts

Working Out

A workout begins in your mind's eye. With concentration and visualization you can approach your workout with a positive, constructive attitude. A good pre-workout mental routine is to sit and relax, so that you can focus on what you are about to do and think about achieving your end goal.

Warming Up

We recommend that you warm up by doing light stretching and performing light exercises.

Your Routine

The workout portion of your fitness routine is the series of exercises devoted to your particular goals. Remember, make sure to have fun!

Cool Down

An essential part of the exercise routine is the cool down. Gradually reduce the level of exercise intensity so that blood does not accumulate in one muscle group, but continues to circulate at a decreasing rate. Remember to gradually move yourself into a relaxed state.

Breathing

The most important part of breathing during exercise is, quite simply, that you do it. Breathing in or out during the actual performance is not dependent upon the direction of air flow relative to exertion. It is, in fact, a mechanical process that changes the position of your spine as your rib cage moves. Here are some tips for breathing:

- 1) Be cautious when you are concentrating or exerting effort. This is when you will probably hold your breath. **DO NOT** hold your breath. Do not exaggerate breathing. Depth of inhalation and exhalation should be natural for the situation.
- 2) Allow breathing to occur, naturally, don't force it.



Consult your physician before starting any exercise program.

If you have not exercised recently, are pregnant, have a heart condition, or any physical limitation, consult with your physician before you use your machine. If you experience tightness in your chest, an irregular heartbeat, shortness of breath, feel faint, lightheaded or dizzy, or have any pain, STOP and consult your physician immediately.

Exercises

Squat (Single Leg)

Muscles worked:

Quadriceps, Glutes

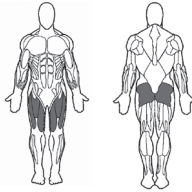

Success Tips

- Keep the chest lifted, abs tight and a slight curve in the lower back.
- On the forward leg, while lowering the body, keep the knee pointed forward.

Bar Position:

Lower

Motion

- Stand facing away from the tower. Extend leg back and place top of foot on back pad.
- Squat down until knee of rear leg is almost in contact with floor.
- Return to original standing position.
- Continue with opposite leg.

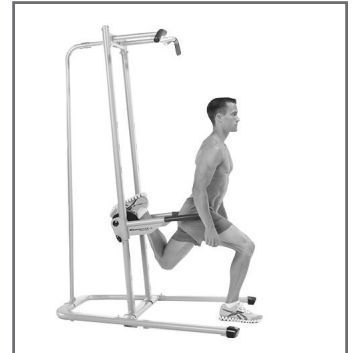

Chin Up

Muscles worked:

Biceps, Latissimus dorsi

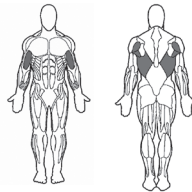

Variation

Use overhand grip.

Bar Position:

Not used

Motion

- Stand facing the tower. Step up and grasp Pull Up Bar with underhand, shoulder-width grip.
- Pull body up until elbows are to sides.
- Lower body until arms and shoulders are fully extended.
- Repeat.



Exercises

Triceps Dip

Muscles worked:

Triceps, Pectoralis major

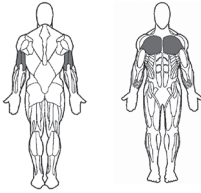

Bar Position:

Middle

Motion

- Stand facing away from the tower. Grasp E-Z Adjust Bars and straighten arms with shoulders above hands.
- Keep hips straight.
- Lower body until upper arms are parallel to ground.
- Push body up until arms are straight.
- Repeat.



Push Up (Decline)

Muscles worked:

Pectoralis Major, Anterior Deltoids



Bar Position:

Lower

Motion

- Kneel on floor facing away from the tower. Position hands on floor slightly wider than shoulder width. Place feet on back pad.
- Raise body in plank position with body straight and arms extended.
- Keeping body straight, lower upper body to floor by bending arms.
- Push body up until arms are extended.
- Repeat.

Success Tips

- To ensure range of motion, the position of the hands should not be too wide.

Variation

Resistance can be increased or decreased by using higher or lower elevation.



Exercises

Supine Row

Muscles worked:

Latissimus Dorsi,
Posterior Deltoids



- Return to seated position.
- Repeat.

Bar Position:

Higher

Accessory:

Handgrips

Motion

- Sit facing tower, with heels braced on tower base frame. Bend knees and grasp handgrips.
- Keeping heels in contact with the floor, and elbows pointed slightly outward, pull body towards bar until legs, hip and chest are straight.



Raised Bridge

Muscles worked:

Hip flexors

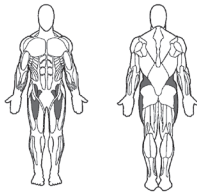

Bar Position:

Lower

Variation

Position hands on floor slightly wider than shoulder width (as shown in photo).

Motion

- Lie prone (on your stomach) on floor facing away from tower. Place feet on top of pad and forearms on floor, elbows under shoulders.
- Raise body upward by straightening body in straight line.
- Hold position.
- Lower body slowly.
- Repeat.



Exercises

Vertical Knee Raise

Muscles worked:

Core, Abdominals

Bar Position:

Not used

Accessory:

Sling straps

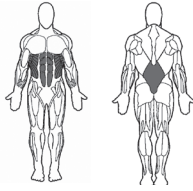

Success Tips

- It may be necessary to completely flex hips before waist flexion is possible.

Variation

To target the obliques, twist at the hips when raising knees.

Motion

- Stand below sling straps. Place upper arms in straps and grasp straps above.
- Raise legs by flexing hips and knees until hips are fully flexed.
- Continue to raise knees toward shoulders by flexing waist.
- Return until waist, hips, and knees are extended downward.
- Repeat.



Crunch

Muscles worked:

Core, Abdominals

Bar Position:

Lowest

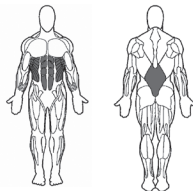

Success Tips

- Keep neck in neutral position with space between chin and sternum.

Motion

- Lie with back on floor and position feet under back pad.
- Cross hands across chest, or place hands behind neck or head.
- Curl trunk to raise upper torso from floor.
- Return until back of shoulders contacts floor.
- Repeat.



Exercises

Squat (Assisted Single Leg)

Muscles worked:

Quadriceps, Glutes

Bar Position:

Middle

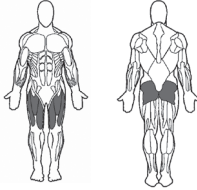

Success Tips

- Keep the supporting knee pointed in the same direction as the foot.

Motion

- Stand facing the tower. Grasp E-Z Adjust Bars with enough contact for balance.
- Balance on one leg with opposite leg extended straight forward as high as possible.
- Squat down while keeping leg elevated and back straight.
- Raise body back up to original position.
- Repeat.
- Continue with opposite leg.

Forward Angle Calf Raise

Muscles worked:

Calves

Bar Position:

Middle

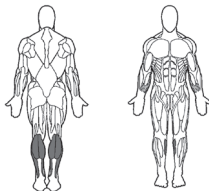

- Repeat.
- Continue with opposite leg.

Success Tips

- Keep supporting knee straight throughout exercise, or bend slightly only during stretch.

Motion

- Stand facing the tower. Grasp E-Z Adjust Bars and step back so body is angled forward with body straight and arms extended perpendicular to body.
- Lift one leg to rear by bending knee.
- Raise heel by extending ankle as high as possible.
- Lower heel allowing foot to come back down flat on floor.

Exercises

Triceps Dip (Assisted)

Muscles worked:

Triceps, Arms, Chest

Bar Position:

Lower

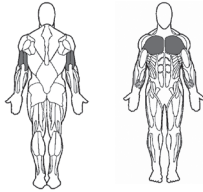

- Lower body until slight stretch is felt in chest or shoulders.
- Repeat.

Motion

- Stand facing away from the tower. Sit between and grip E-Z Adjust Bars with elbows pointing to back of tower.
- Position feet in front with legs bent and torso upright.
- Raise body by straightening your arms.



Chest Dip

Muscles worked:

Chest, Pectorals

Bar Position:

Higher



- When slight stretch is felt in chest or shoulders, push body up until arms are straight.
- Repeat.

Motion

- Face away from tower.
- Mount E-Z Adjust Bars using your arms and then straighten arms, with shoulders above hands.
- Lean forward slightly, and gradually bend knees and hips.
- Lower body by bending arms, allowing elbows to flare out to sides.

Exercises

Incline Push Up

Muscles worked:

Chest, Pectorals



Bar Position:

Lower

Success Tips

- Keep upper and lower body straight throughout movement.

Motion

- Stand facing tower, and place hands on E-Z Adjust Bars.
- Move feet back from tower, with arms and body straight. Arms should be perpendicular to body.
- Keeping body straight, lower chest toward your hands by bending arms.
- Push body up until arms are extended.
- Repeat.



Pull Up

Muscles worked:

Shoulders, Latissimus Dorsi

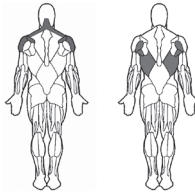

Bar Position:

Lowest

Success Tips

- To ensure range of motion, grip should not be too wide.

Variation

Do exercise using a narrower grip.

Motion

- Face tower and grasp Pull Up Bar with overhand wide grip.
- Pull body up until eyes are above the bar.
- Lower body until arms and shoulders are fully extended.
- Repeat.

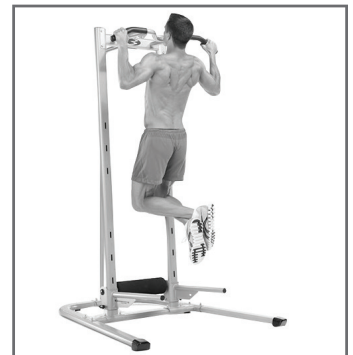

Exercises

Hanging Leg Raise

Muscles worked:

Glutes, Hip Flexors

Bar Position:

Not used

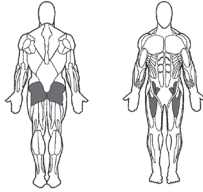

Success Tips

- It may be necessary to completely flex hips before waist flexion is possible.

Variation

Use sling straps. Or keep knees extended throughout leg raise.

Motion

- Stand facing away from the tower. Grasp and hang from Pull Up Bar with overhand grip, slightly wider than shoulder width.
- Raise legs by flexing hips and knees until knees are well above hips.
- Return until hips and knees are extended downward.
- Repeat.

Rear Decline Plank

Muscles worked:

Lower Back

Bar Position:

Lower



Variation

Resistance can be increased or decreased by using higher or lower elevation.

Motion

- Lie supine (on your back) on the floor facing away from tower.
- Place ankles on back pad while bending at the waist, knees slightly bent.
- Raise hips up off floor until hips are straight.
- Hold position.



Exercises

Hanging Hip-Leg Raise

Muscles worked:

Core, Abdominals

Bar Position:

Not used

Accessory:

Sling straps

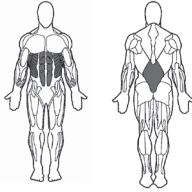

- Return until waist and hips are extended downward.
- Repeat.

Success Tips

- It may be necessary to completely flex hips before waist flexion is possible.

Motion

- Face away from tower. Stand below sling straps.
- Place upper arms in straps and grasp straps above.
- Raise legs by flexing hips until fully flexed, tuck knees, and raise feet toward pull-up bar by flexing waist.

Variation

Do exercise without sling straps by holding the Pull Up Bar.

Inverted Row (Assisted)

Muscles worked:

Shoulders, Posterior Deltoids

Bar Position:

Lower

Accessory:

Handgrips

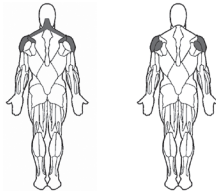

- Return to original position.
- Repeat.

Motion

- Sit facing tower, with knees bent and heels braced on tower base frame.
- Grasp handgrips and lie supine (on your back).
- Keeping heels in contact with the floor, and elbows pointed slightly outward, stay seated and pull body towards back of tower, while bending at the hip, until seated upright.

This page intentionally left blank.

Muscle Chart

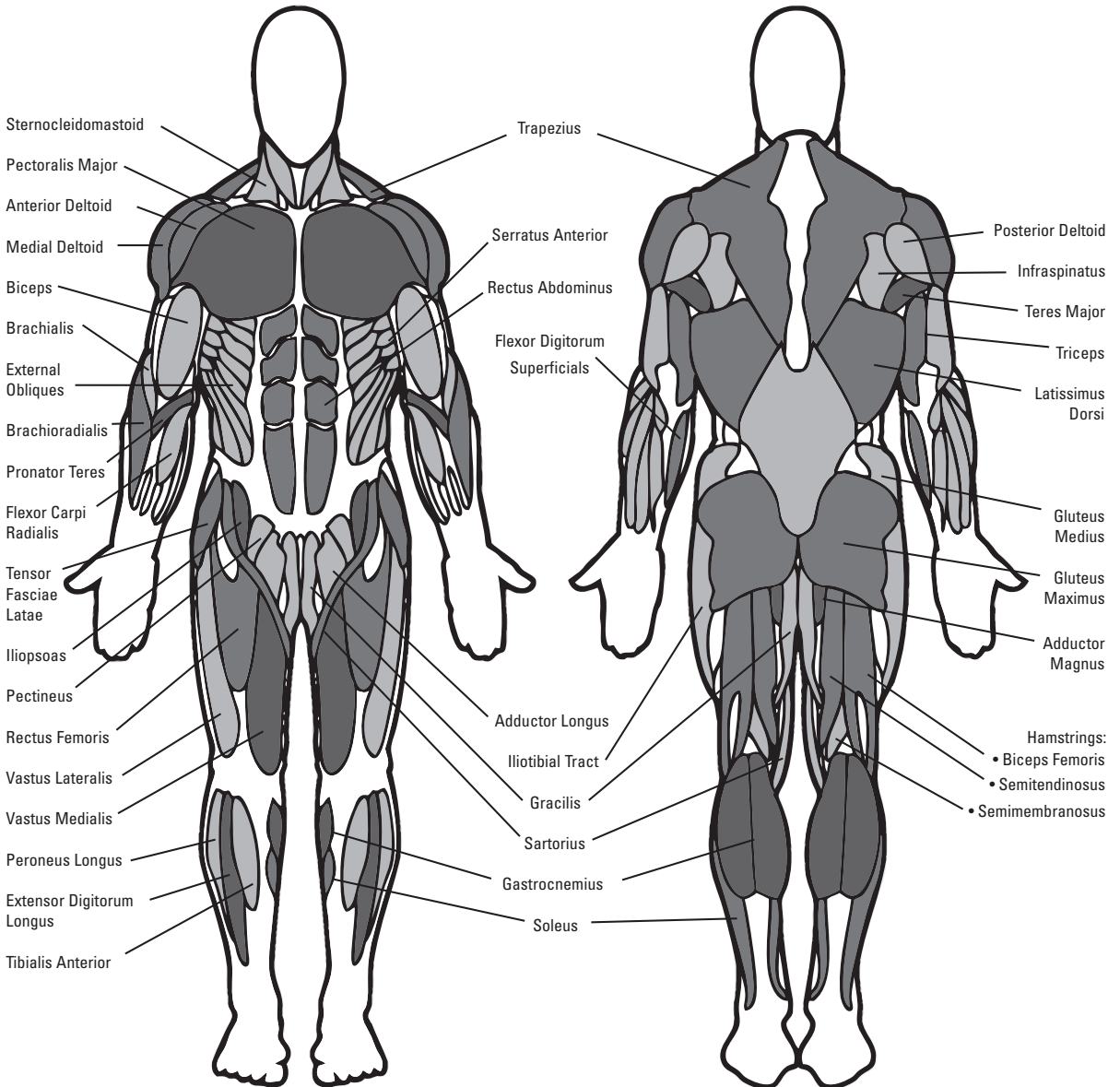

Maintenance



Equipment must be regularly examined for damage and repairs. The owner is responsible to make sure that regular maintenance is done. Worn or damaged components must be replaced immediately or the equipment removed from service until the repair is made. Only manufacturer supplied components can be used to maintain and repair the equipment.

If at any time the Warning labels become loose, unreadable or dislodged, contact Nautilus Customer Service for replacement labels.

Daily/Before Each Use: Examine machine. Make sure it looks in good condition and operates smoothly. If you find damage, DO NOT USE.

Daily/After Each Use: Clean machine with a clean, dry cloth. Do not use cleansers containing enzymes.

Weekly: Clean machine fully with a clean cloth lightly dampened with warm water and a small amount of mild soap. Wipe dry with a separate cloth. Touch up any scratches with touch-up paint to prevent rust, if necessary.

Monthly: Examine the frame for signs of cracking or permanent bending. Do not use the equipment if you see this. Contact Nautilus Customer Service immediately.





Nautilus®

Bowflex®

Schwinn®

Universal®