



If purchased in US/Canada:

! WARNING

Do not operate this machine until you read and understand the complete Owner's Manual provided online here: <http://www.bowflex.com/manuals>

In the event that you do not have a computer or on-line access and require a hard copy of the Manual, please contact Nautilus at (800) 605-3369 and we will provide one for you. In either case, before first use please read and understand the Owner's Manual.

If purchased outside US/Canada:

! WARNING

Do not operate this machine until you read and understand the complete Owner's Manual provided online here: www.nautilusinternational.com or www.nautilus.cn

To validate warranty support, keep the original proof of purchase and record the following information:

Serial Number _____

Date of Purchase _____

If purchased in US/Canada: To register your product warranty, go to: www.bowflex.com/register or call 1 (800) 605-3369.

If purchased outside US/Canada: To register your product warranty, contact your local distributor.

For warranty and service of products purchased outside US/Canada, please contact your local distributor. To find your local international distributor, go to: www.nautilusinternational.com.

IMPORTANT SAFETY INSTRUCTIONS

When using an electrical appliance, basic precautions should always be followed, including the following:

! This icon means a potentially hazardous situation which, if not avoided, could result in death or serious injury.

Obey the following warnings:

- !** Read and understand all warnings on this machine.
- !** Carefully read and understand the Assembly instructions.

! DANGER

Carefully read and understand the Assembly instructions. Read and understand the complete Manual. Keep the Manual for future reference.

! WARNING

To decrease the risk of burns, electric shock, or injury to persons, read and understand the complete Owner's Manual. Failure to follow these guidelines can cause a serious or possibly fatal electrical shock or other serious injury.

- Keep bystanders and children away from the product you are assembling at all times.
- Do not connect power supply to the machine until instructed to do so.
- The machine should never be left unattended when plugged in. Unplug from outlet when not in use and before cleaning, maintaining or repairing the machine.
- Before each use, examine the machine for damage to power cord, loose parts or signs of wear. Do not use if found in this condition. If purchased in US/Canada, contact Customer Service for repair information. If purchased outside US/Canada, contact your local distributor for repair information.

- Not intended for use by persons with medical conditions where those conditions may impact the safe operation of the machine or pose a risk of injury to the user.
- Do not drop or put objects into any opening of the machine.
- Never operate this machine with the air openings blocked. Keep the air openings free of lint, hair and the like.
- Do not assemble this machine outdoors or in a wet or moist location.
- Make sure assembly is done in an appropriate work space away from foot traffic and exposure to bystanders.
- Some components of the machine can be heavy or awkward. Use a second person when doing the assembly steps involving these parts. Do not do steps that involve heavy lifting or awkward movements on your own.
- Set up this machine on a solid, level, horizontal surface.
- Do not try to change the design or functionality of this machine. This could compromise the safety of this machine and will void the warranty.
- If replacement parts are necessary, use only genuine Nautilus replacement parts and hardware. Failure to use genuine replacement parts can cause a risk to users, keep the machine from operating correctly and void the warranty.
- Do not use until the machine has been fully assembled and inspected for correct performance in accordance with the Manual.
- Read and understand the complete Manual supplied with this machine before first use. Keep the Manual for future reference.
- Do all assembly steps in the sequence given. Incorrect assembly can lead to injury or incorrect function.

• SAVE THESE INSTRUCTIONS.

Before using this equipment, obey the following warnings:

-  **Read and understand the complete Manual. Keep the Manual for future reference.**
- **Read and understand all warnings on this machine. If at any time the Warning labels become loose, unreadable or dislodged, replace the labels. If purchased in US/Canada, contact Customer Service for replacement labels. If purchased outside US/Canada, contact your local distributor for them.**

- Children must not be let on or near to this machine. Moving parts and other features of the machine can be dangerous to children.
- Not intended for use by anyone under 14 years of age.
- Consult a physician before you start an exercise program or a new health and diet plan. Stop exercising if you feel pain or tightness in your chest, become short of breath, or feel faint. Contact your doctor before you use the machine again. Use the values calculated or measured by the machine's computer for reference purposes only. The heart rate displayed on the console is an approximation and should be used for reference only.
- Before each use, examine this machine for loose parts or signs of wear. Do not use if found in this condition. Monitor the Pedals and Crank Arms closely. If purchased in US/Canada, contact Customer Service for repair information. If purchased outside US/Canada, contact your local distributor for repair information.
- Maximum user weight limit: 136 kg (300 lbs.). Do not use if you are over this weight.
- This machine is for home use only. Do not place or use the machine in a commercial or institutional setting. This includes gyms, corporations, work places, clubs, fitness centers and any public or private entity that has a machine for use by its members, customers, employees or affiliates.
- Do not wear loose clothing or jewelry. This machine contains moving parts. Do not put fingers or other objects into moving parts of the exercise equipment.
- Set up and operate this machine on a solid, level, horizontal surface.
- Make the Pedals stable before you step on them. Use caution when you step on and off the machine.
- Do not operate this machine outdoors or in moist or wet locations.
- Keep at least 0.6 m (24") along the side used to access the machine and to the rear of the machine clear. This is the recommended safe distance for access, passage and emergency dismounts from the machine. Keep third parties out of this space when machine is in use.
- Do not over exert yourself during exercise. Operate the machine in the manner described in this manual.
- Perform all regular and periodic maintenance procedures recommended in the Owner's Manual.
- Keep the Pedals and Handlebars clean and dry.
- Exercise on this machine requires coordination and balance. Be sure to anticipate that changes in speed and resistance level can occur during workouts, and be attentive in order to avoid loss of balance and possible injury.
- This machine cannot stop the Pedals or Upper Handlebars independently of the Resistance Fan. Reduce the pace to slow the Resistance Fan, Upper Handlebars and Pedals to a stop. Do not dismount the machine until the Pedals and Upper Handlebars have come to a complete stop.
- Do not drop or put objects into any opening of the machine.
- Prior to use read and understand the Owner's Manual. The appliance is not to be used by persons with functional limitations and impairments, reduced physical, sensory or mental capabilities, or lack of experience and knowledge.
- This appliance is not intended for use by persons with reduced physical, sensory or mental capabilities, or lack of knowledge, unless they have been given supervision or instruction concerning use of the appliance by a person responsible for their safety. Keep children under the age of 14 away from this machine.
- Children should be supervised to ensure that they do not play with the appliance.
- Use the values calculated or measured by the machine's computer for reference purposes only. The heart rate displayed is an approximation and should be used for reference only. Over exercising may result in serious injury or death. If you feel faint stop exercising immediately.

• SAVE THESE INSTRUCTIONS.

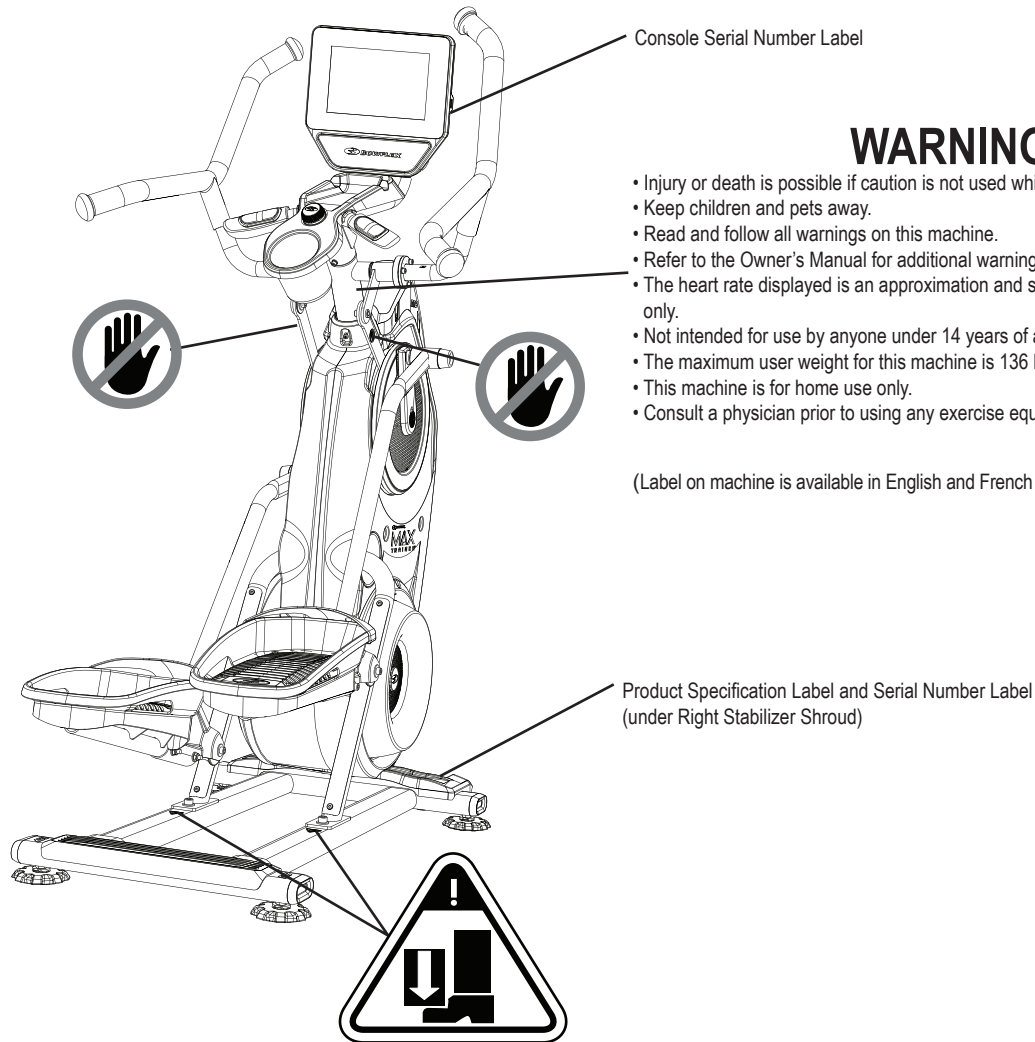

WARNING!

- Injury or death is possible if caution is not used while using this machine.
- Keep children and pets away.
- Read and follow all warnings on this machine.
- Refer to the Owner's Manual for additional warnings and safety information.
- The heart rate displayed is an approximation and should be used for reference only.
- Not intended for use by anyone under 14 years of age.
- The maximum user weight for this machine is 136 kg. (300 lbs)
- This machine is for home use only.
- Consult a physician prior to using any exercise equipment.

(Label on machine is available in English and French Canadian only.)

FCC Compliance

 Changes or modifications to this unit not expressly approved by the party responsible for compliance could void the user's authority to operate the equipment.

The machine and power supply comply with part 15 of the FCC rules. Operation is subject to the following two conditions: (1) This device may not cause harmful interference, and (2) this device must accept any interference received, including interference that may cause undesired operation.

Note: This machine and power supply have been tested and found to comply with the limits for a Class A digital device, pursuant to Part 15 of the FCC Rules. These limits are designed to provide reasonable protection against harmful interference in a residential installation. This equipment generates, uses and can radiate radio frequency energy and, if not installed and used in accordance with the instructions, may cause harmful interference to radio communications.

However, there is no guarantee that interference will not occur in a particular installation. If this equipment does cause harmful interference to radio or television reception, which can be determined by turning the equipment off and on, the user is encouraged to try to correct the interference by one or more of the following measures:

- Reorient or relocate the receiving antenna.
- Increase the separation between the equipment and receiver.
- Connect the equipment into an outlet on a circuit different from that to which the receiver is connected.
- Consult the dealer or an experienced radio/TV technician for help.

This product complies with the European Radio Equipment Directive 2014/53/EU

Specifications

- Maximum User Weight:** 136 kg (300 lbs.)
- Total Surface Area (footprint) of equipment:** 9775 cm² (1515.4 in²)
- Maximum Pedal Height:** 48.5 cm (19.1 inches)
- Machine Weight:** approx. 67.5 kg (148.8 lbs.)
- Power Requirements:**
(AC Adaptor)
 Input Voltage: 100-240V AC, 50-60Hz, 1.5A
 Output Voltage: 12V DC, 3A
- Heart Rate Armband:** 1 Lithium Polymer battery (not replaceable)

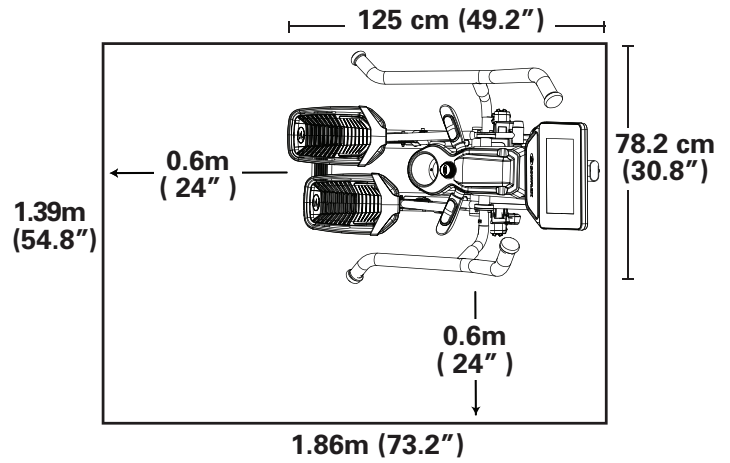

Machine Height: 165.4 cm (65.1")



DO NOT dispose of this product as refuse. This product is to be recycled. For proper disposal of this product, please follow the prescribed methods at an approved waste center.

Before Assembly

Select the area where you are going to set up and operate your machine. For safe operation, the location must be on a hard, level surface. Allow a workout area of a minimum 139 cm (54.8") x 186 cm (73.2"). Keep the workout area clear 0.6m (24") along the side used to access the machine and to the rear of the machine. Be sure that the workout space you are utilizing has adequate height clearance, taking into consideration the height of the user and the maximum pedal height of the fitness machine.

Machine Mat

The Bowflex™ Max Trainer™ Machine Mat is an optional accessory that helps keep your workout area clear and adds a layer of protection to your floor. The rubber machine mat provides a non-slip, rubber surface which limits static discharge and reduces the possibility of display errors. If possible, put your Bowflex™ Max Trainer™ Machine Mat in your selected workout area before you begin assembly.

To order the optional machine mat, contact Customer Service (if purchased in US/Canada) or your local distributor (if purchased outside US/Canada).

Assembly

Hardware

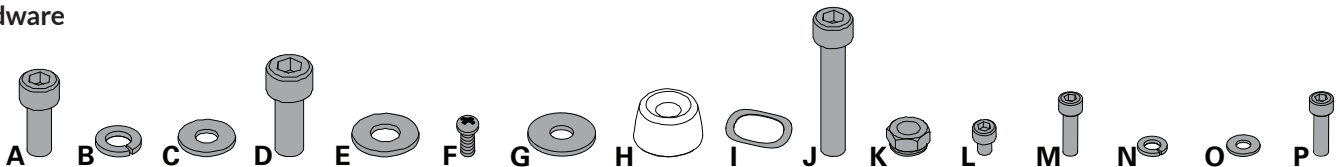

Item	Qty	Description	Item	Qty	Description
A	6	Socket Head Hex Screw, M8x1.25x20 Black	I	2	Wave Washer, 17.2x22
B	6	Lock Washer, M8x14.8 Black	J	4	Socket Head Hex Screw, M8x1.0x55 Black
C	12	Washer, Flat M8x18 Black	K	4	Lock Nut, M8 Black
D	4	Socket Head Hex Screw, M10x1.5x25 Black	L	8	Socket Head Hex Screw, M6x1.0x8 Black
E	4	Washer, Flat M10x23 Black	M	4	Socket Head Hex Screw, M6x1.0x20 CL10.9 Black
F	1	Pan Phillips Screw, M5x0.8x20 Black	N	10	Lock Washer, M6x14.8 Black
G	2	Washer, Flat M8x24 Black	O	4	Washer, Flat M6x13 Black
H	2	Cap	P	6	Socket Head Hex Screw, M6x1.0x20 CL12.9 Black

Note: Select pieces of Hardware have been provided as spares on the Hardware Card. Be aware that there may be remaining Hardware after the proper assembly of your machine.

Tools

Included



#2
5 mm
6 mm
8 mm



13 mm

Step 1.

! Some components of the machine can be heavy or awkward. Use a second person when doing the assembly steps involving these parts. Do not do steps that involve heavy lifting or awkward movements on your own.

NOTICE: Hand tighten hardware.

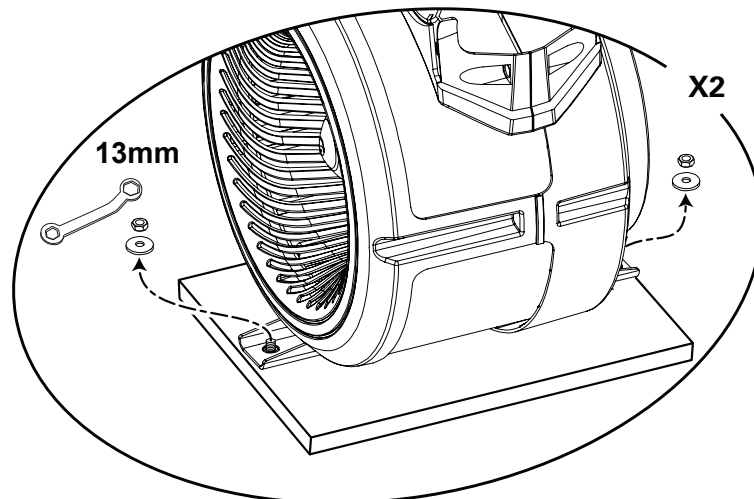
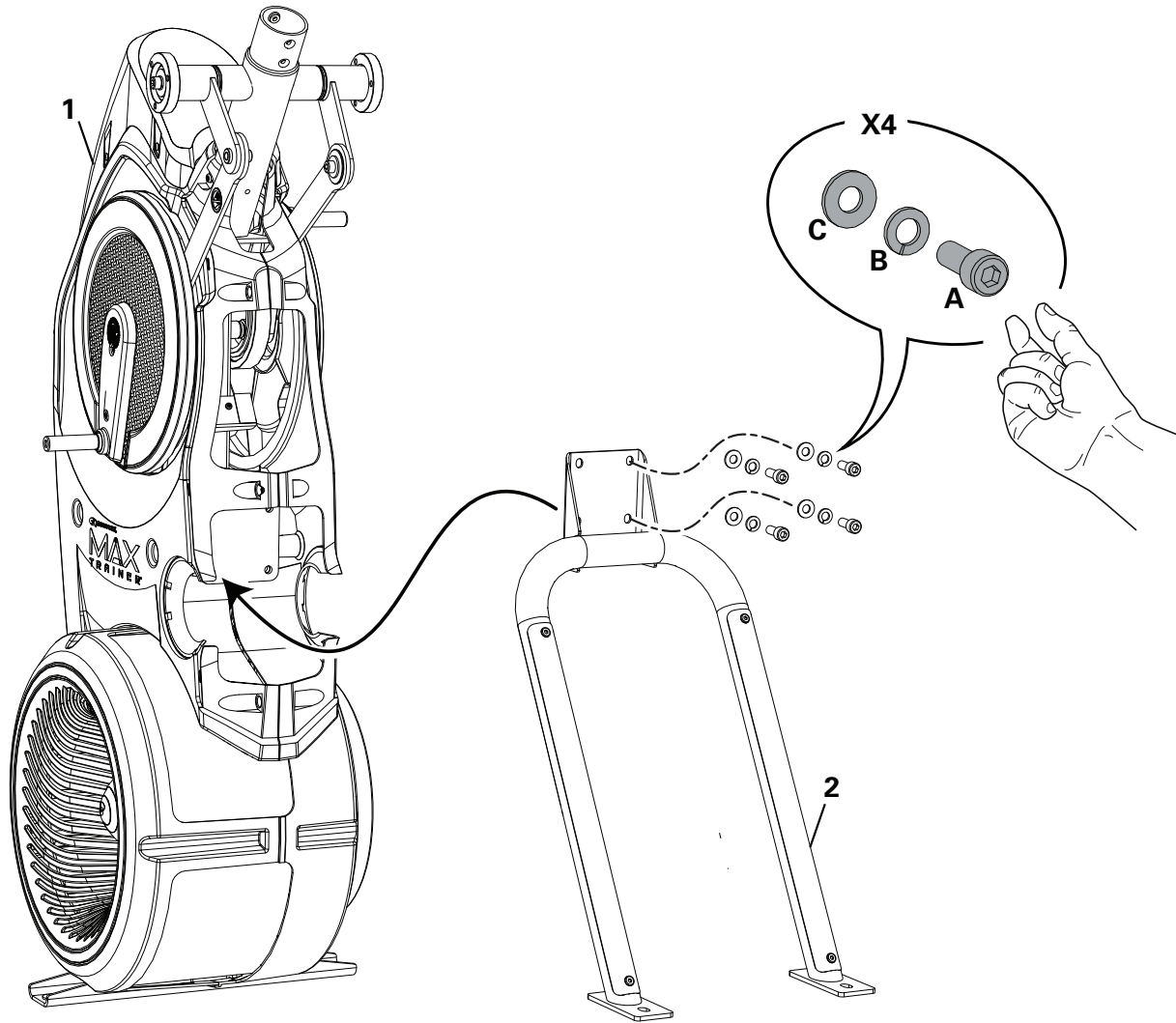

Item	Qty	Description	Item	Qty	Description
1	1	Frame	2	1	Rail Assembly

Step 2.

! Some components of the machine can be heavy or awkward. Use a second person when doing the assembly steps involving these parts. Do not do steps that involve heavy lifting or awkward movements on your own. Lift the Frame Assembly from the exterior of the pivot assembly as indicated below.

NOTICE: Once all hardware has been hand tightened, fully tighten ALL hardware from previous steps. Place the inside hook of the Rear Shroud on the Frame Assembly and then pivot it up into place.

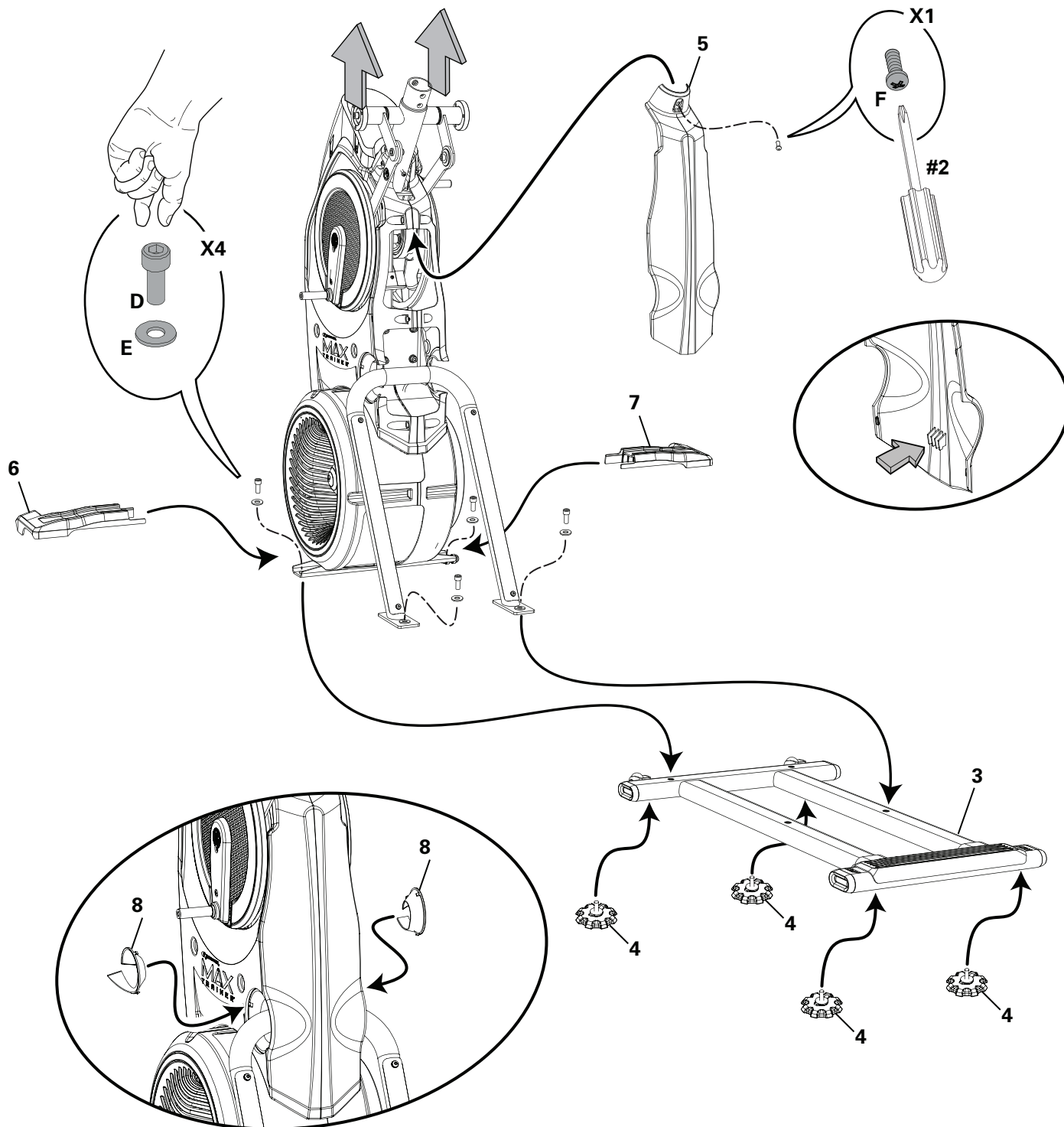

Item	Qty	Description	Item	Qty	Description	Item	Qty	Description
3	1	Stabilizer Assembly	5	1	Shroud, Rear	7	1	Stabilizer Shroud, Right
4	4	Leveler	6	1	Stabilizer Shroud, Left	8	2	Cap

Step 3.

! Be aware that the Legs are connected and when either of these parts move the other does as well. In order to avoid possible serious injury, when inserting the tube ends into the Leg Assemblies be careful to avoid fingers or hands being caught or pinched.

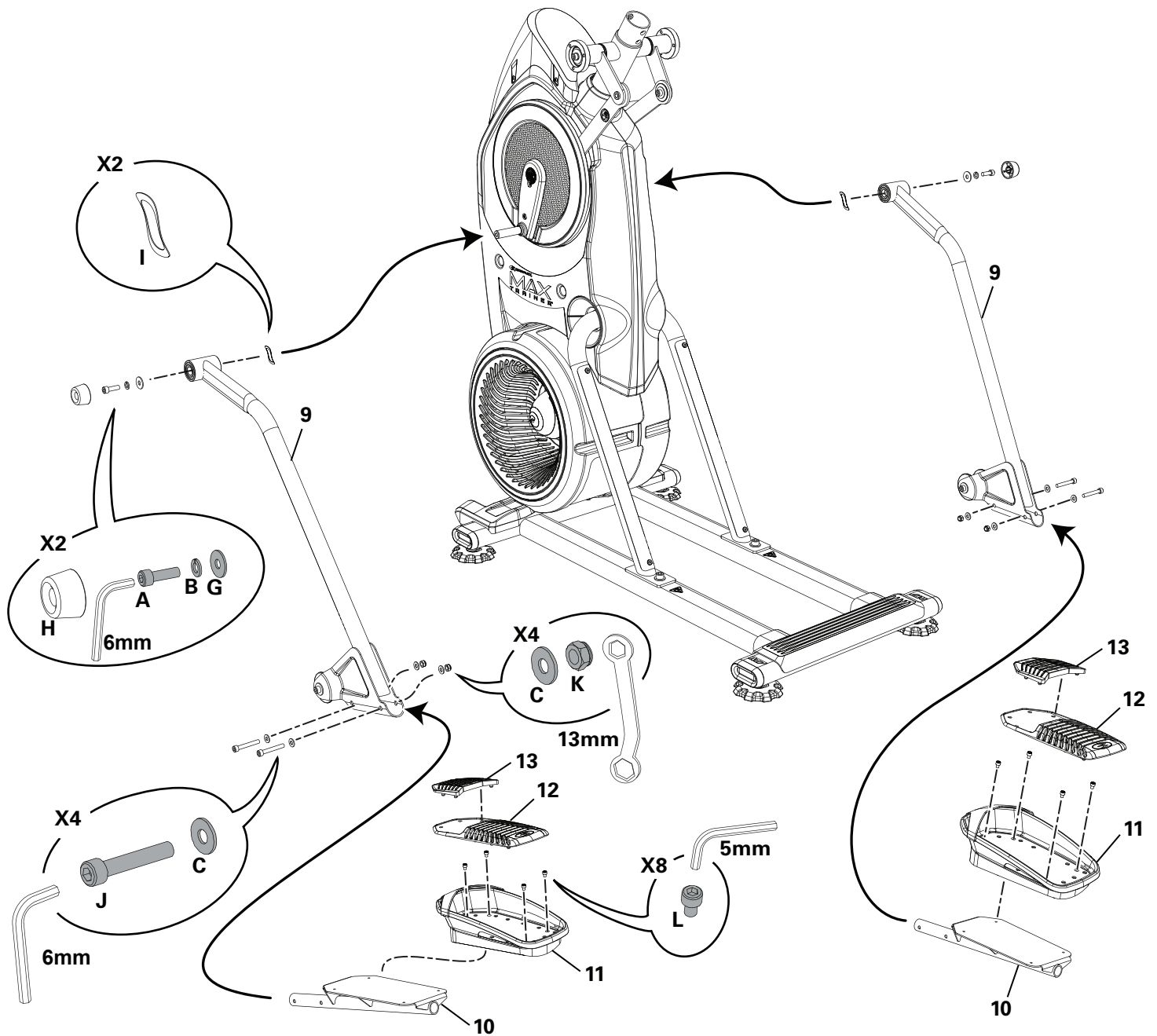

Item	Qty	Description	Item	Qty	Description	Item	Qty	Description
9	2	Leg	11	2	Foot Platform	13	2	Foot Pad Insert
10	2	Pedal	12	2	Foot Pad			

Step 4.

NOTICE: Cut the Shipping Zip-Tie that Secures the Cables, Connect the Cables, and Attach the Static Handlebar Assembly and Resistance Level Knob.

Note: Do not let the Cables drop into the Frame Assembly. Do not cut or crimp the Console Cables. Once all hardware has been hand tightened, fully tighten the hardware with the 5mm hex wrench.

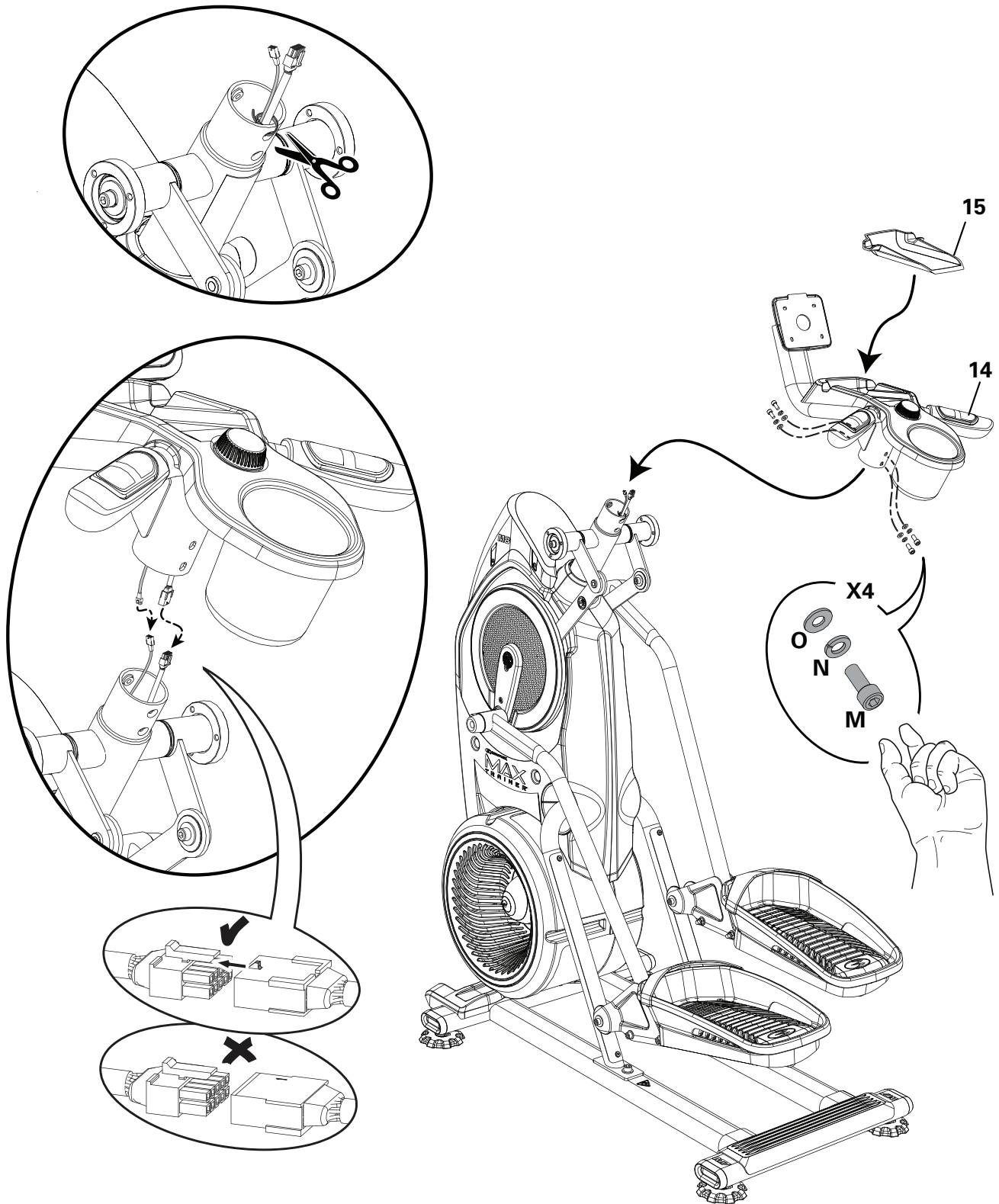

Item	Qty	Description	Item	Qty	Description
14	1	Static Handlebar Assembly	15	1	Tray Insert

Step 5.

NOTICE: Remove the Rear Console Cover and Hardware from the Console Assembly. Connect the Cables and Place the Console onto the Static Handlebar. With the Excess of the Cables Pushed into the Static Handlebar, Pivot the Console Assembly Downward and Secure It to the Static Handlebars.

Note: Do not cut or crimp the Cables. Each Cable connector (3-pin, 4-pin, 5-pin and 12-pin) has a corresponding end connector with that many openings. * Hardware is not supplied on the Hardware Card.

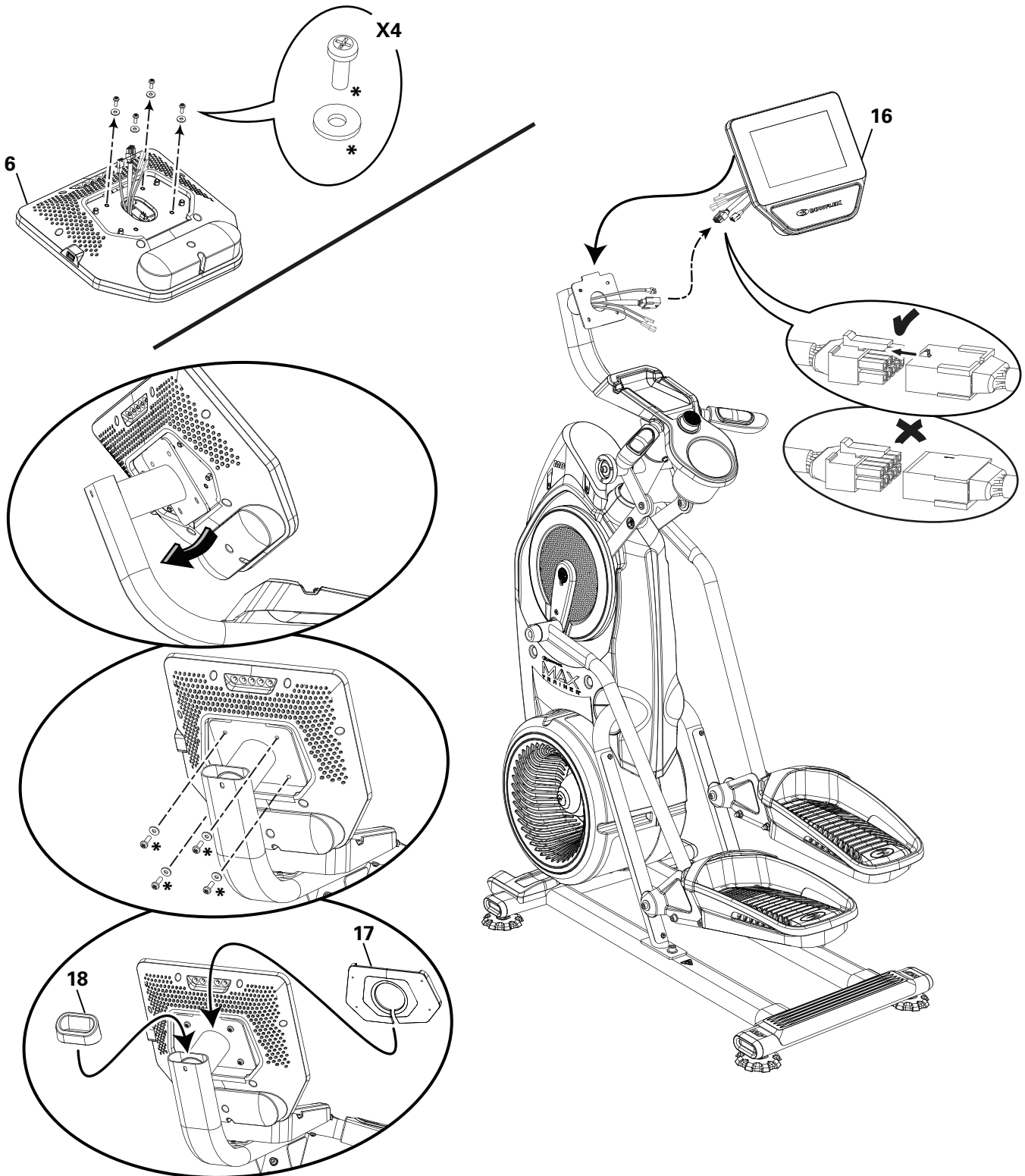

Item	Qty	Description	Item	Qty	Description	Item	Qty	Description
16	1	Console Assembly	17	1	Console Rear Cover	18	1	Static Handlebar Cap

Step 6.

! Be aware that the Pedals and the Upper Handlebars are connected and when either of these parts move the other does as well. Some components of the machine can be heavy or awkward. Use a second person when doing the assembly steps involving these parts. Do not do steps that involve heavy lifting or awkward movements on your own.

NOTICE: Be sure to attach the Upper Handlebars so that they are in the range of operation for the User. Be sure to use the appropriate AC Adapter plug for your region.

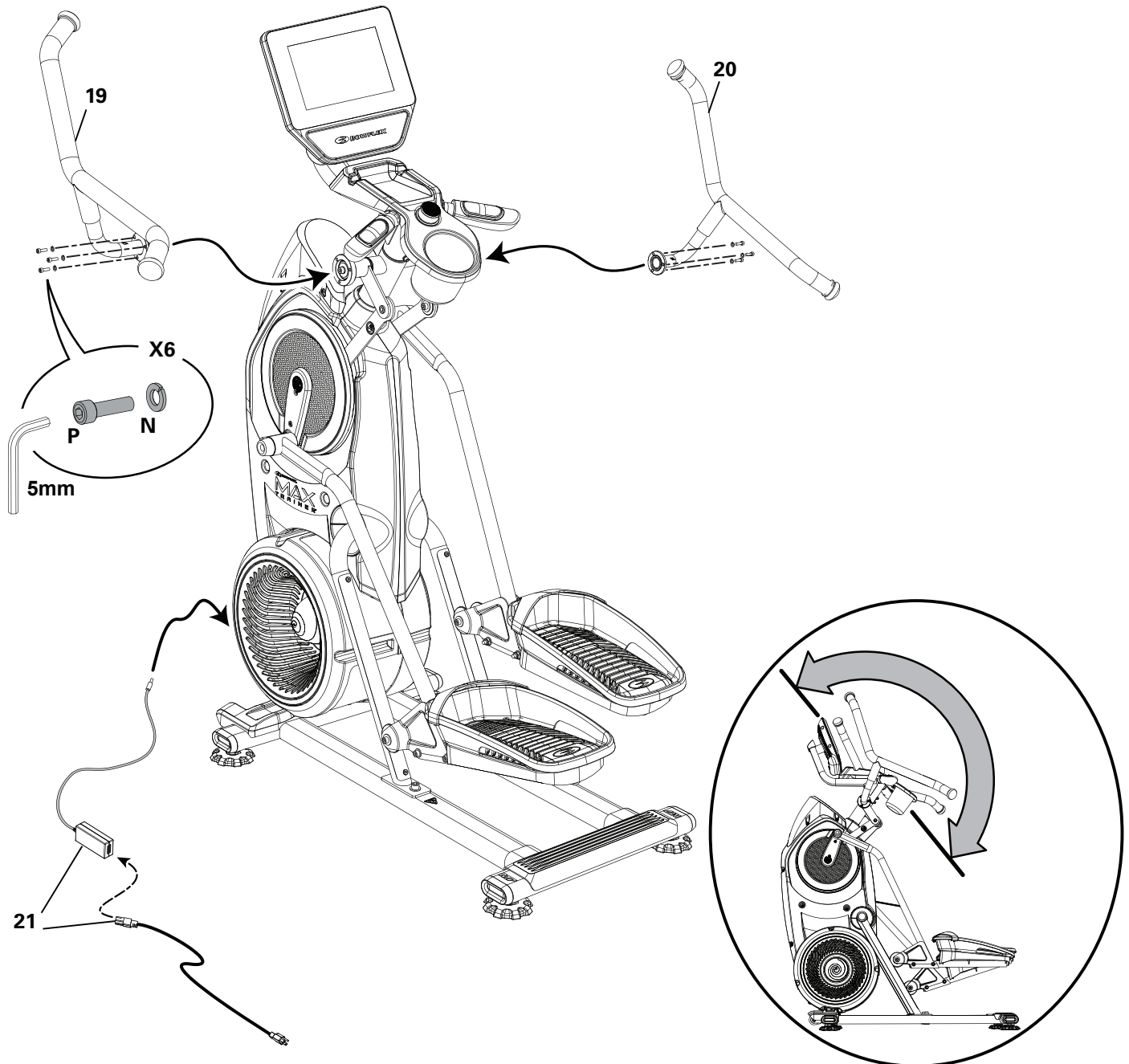

Item	Qty	Description	Item	Qty	Description	Item	Qty	Description
19	1	Dynamic Handlebar, Left	20	1	Dynamic Handlebar, Right	21	1	AC Adapter

Step 7.

- a. With the machine plugged into a functioning wall outlet, the machine will start up and the red Status LED will activate.

Note: The Console may go to sleep if it does not receive any input. Touch the screen of the Console to wake up the machine.

- b. The machine will activate and display the Welcome - Connect Wifi screen. Tap on Connect.

Note: A Wifi connection is required to use your Bowflex™ machine. If you do not have a Wifi connection available, contact your Bowflex™ Representative or your local distributor immediately for further assistance.

- c. The Console will display the list of available Wifi connections. Tap on the desired Wifi connection, and enter the password. Tap on Connect.
- d. The Console will test and connect to the Wifi connection.

If the Console displays an Update Available screen, tap on the Agree button. The Console will update the software.

- e. With a Wifi connection established, tap on Back.
- f. Tap on Get Started.
- g. The Console will display the options screen. Choose Log In or Create Account. Follow the prompts to register your new fitness machine. When registration is completed, your fitness machine is now ready for use.

Note: The Bowflex™ machine must be registered using a Wifi connection. Once the initial registration and configuration is completed, the machine can be operated without a Wifi connection. However, only the basic workouts and functions will be available for use. All coaching, custom workouts, Explore The World™ virtual outdoor immersive runs and trainer lead workout videos are only available through a Wifi connection with a JRNY™ membership*.

- h. The Console will display the Just for You screen. The screen will prompt you to do your Fitness Assessment workout to get a custom workout*. You can go to the Learn tab for more information about your options.

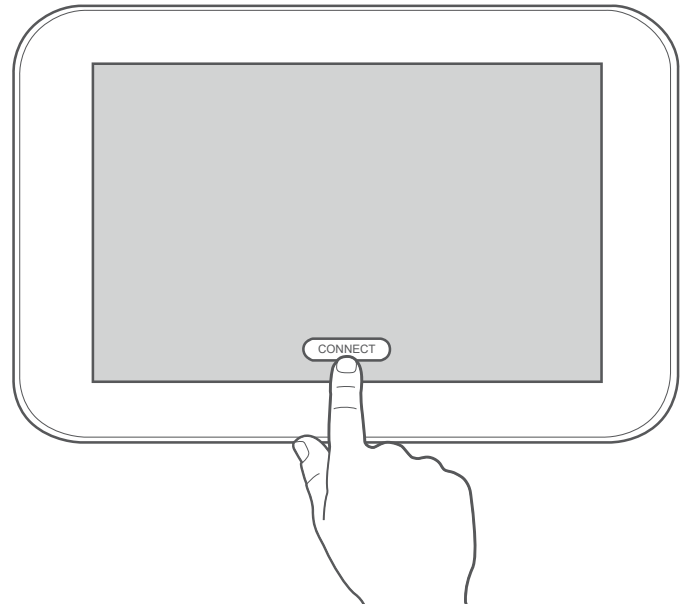

Step 8.

Final Inspection

Inspect your machine to ensure that all hardware is tight and components are properly assembled.

Note: Remove any protective covers from the face of the Console. Remove the plastic scratch guard strips from Rails.

Be sure to record the serial number in the field provided at the front of this manual.



Do not use until the machine has been fully assembled and inspected for correct performance in accordance with the Owner's Manual.

* A JRNY™ membership is required for the JRNY™ experience – see www.bowflex.com/jrny for details. For United States and Canada customers, you can obtain a JRNY™ membership by calling 800-269-4126 or visiting www.bowflex.com/jrny. Where available (including the United States), you can also obtain a JRNY™ membership by downloading the JRNY™ app onto your phone or tablet and signing up within the downloaded app. JRNY™ memberships may not be available in all countries.

Adjustments / Operations

Moving the Machine

! The machine may be moved by one or more persons depending on their physical abilities and capacities. Make sure that you and others are all physically fit and able to move the machine safely.

1. Grasp the Main Bar of the Static Handlebar Assembly to carefully tilt the machine toward you onto the transport rollers. Be sure not to grab the Console Display.

! Be aware of the Handlebars and the weight of the machine before tilting the machine.

2. Push the machine into position.
3. Carefully lower the machine into position.

NOTICE: Be careful when you move the machine. All abrupt motions can affect the computer operation.

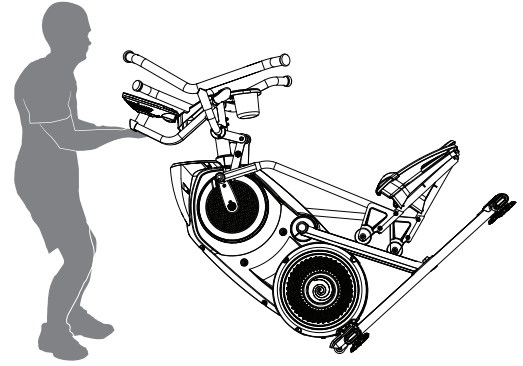

Leveling the Machine

The machine needs to be leveled if your workout area is uneven or if the Rail Assembly is slightly off the floor. To adjust:

1. Place the machine in your workout area.
2. Loosen the locking nuts and adjust the levelers until they are evenly balanced in contact with the floor.

! Do not adjust the levelers to such a height that they detach or unscrew from the machine. Injury to you or damage to the machine can occur.

3. Tighten the locking nuts.

! Make sure the machine is level and stable before you exercise.

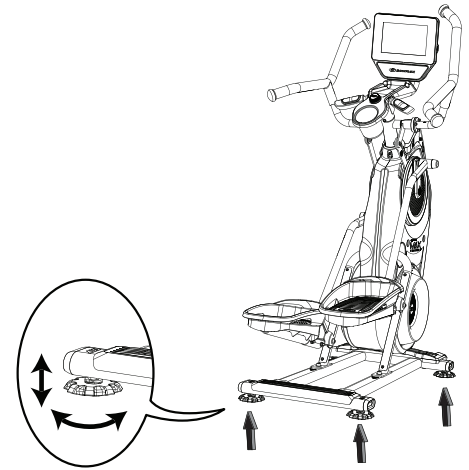

USB Charging

If a USB Device is attached to the USB Port, the Port will attempt to charge the Device. The power supplied from the USB Port may not be enough to operate the Device and charge it at the same time.

Using the Bowflex™ JRNY™ App on your Portable Device (Optional)

Though you can access your completed workout information from your console with your JRNY™ membership, you can also access this information remotely on your own device. Simply download the JRNY™ app to your device for access to your JRNY™ membership.

1. Download the app, named "Bowflex™ JRNY™ App". The app is available on Google Play™ and the App Store.

Note: For a complete list of supported devices, review the app on the App Store or Google Play™.

2. Follow the instructions on the app to sync your device to your Bowflex™ JRNY™ membership.

When your device has access to the account, you will be able to review past workouts, coaching, and upcoming workouts with your JRNY™ membership*.

Bluetooth® Heart Rate Monitor Enabled

Your fitness machine is equipped to be able to receive a signal from a Bluetooth® Heart Rate (HR) Monitor. Follow the instructions provided with your Bluetooth® HR monitor.

! If you have a pacemaker or other implanted electronic device, consult your doctor before using a Bluetooth® strap or other Bluetooth® heart rate monitor.

Note: Be sure to remove the protective cover (if provided) from the Heart Rate Sensor before use.

* A JRNY™ membership is required for the JRNY™ experience – see www.bowflex.com/jrny for details. For United States and Canada customers, you can obtain a JRNY™ membership by calling 800-269-4126 or visiting www.bowflex.com/jrny. Where available (including the United States), you can also obtain a JRNY™ membership by downloading the JRNY™ app onto your phone or tablet and signing up within the downloaded app. JRNY™ memberships may not be available in all countries.

Bluetooth® Heart Rate Armband

A Bluetooth® Heart Rate Armband is provided with your fitness machine. To use the Bluetooth® Heart Rate Armband, follow the instructions that were included with the Armband.

! If you have a pacemaker or other implanted electronic device, consult your doctor before using a Bluetooth® armband or other Bluetooth® heart rate monitor.

Note: Be sure to remove the protective cover (if provided) from the Heart Rate Sensor before use.

1. Put the Bluetooth® Heart Rate Armband onto the upper portion of your forearm.
2. Confirm that the Bluetooth® wireless connection is active on the machine. If the Bluetooth® icon is blue, then it is active.
If the icon is red, then the Bluetooth® wireless connection must be activated. To activate the Bluetooth® wireless connection:
 - a. Tap the Bluetooth® icon.
 - b. Tap "Manage Bluetooth®".
 - c. Slide the option from "OFF" to "ON".
 - d. Tap Back to exit.
3. When ready to exercise, start your workout.
4. Push the On/Off LED button on the Heart Rate Armband. Be sure to only push the On/Off LED button once.
5. During your workout, the Heart Rate Armband may take up to 60 seconds to connect. When connected, the Bluetooth® Heart Rate Device icon will be displayed along with your heart rate.

Note: The Armband can only be connected once to an active workout. If the On/Off LED button is pushed after being connected, the workout must be restarted.



Bluetooth® Audio (in or out)

Your machine is able to play audio across a Bluetooth® connection from your smart device through the console speakers. The machine can also stream audio from the console to your Bluetooth® device (such as Bluetooth® headphones).

Note: Bluetooth® audio can only be streamed in one direction (in or out) at a time.

Contact Heart Rate Sensors

Contact Heart Rate (CHR) sensors send your heart rate signals to the Console. The CHR sensors are the stainless steel parts of the Handlebars. To use, put your hands comfortably around the sensors. Be sure that your hands touch both the top and the bottom of the sensors. Hold firm, but not too tight or loose. Both hands must make contact with the sensors for the Console to detect a pulse. After the Console detects four stable pulse signals, your initial pulse rate will be shown.

Once the Console has your initial heart rate, do not move or shift your hands for 10 to 15 seconds. The Console will now validate the heart rate. Many factors influence the ability of the sensors to detect your heart rate signal:

- Movement of the upper body muscles (including arms) produces an electrical signal (muscle artifact) that can interfere with pulse detection. Slight hand movement while in contact with the sensors can also produce interference.
- Calluses and hand lotion may act as an insulating layer to reduce the signal strength.
- Some Electrocardiogram (EKG) signals generated by individuals are not strong enough to be detected by the sensors.
- The proximity of other electronic machines can generate interference.

! Use the values calculated or measured by the machine's computer for reference purposes only.

Media Rack (Optional Accessory)

An optional accessory can be added to your fitness machine that will hold additional media above the Console. The optional Media Rack easily attaches to your machine, adding more space for media and devices.

To order the optional Media Rack, contact Customer Service (if in US/Canada) or your local distributor (if outside US/Canada).

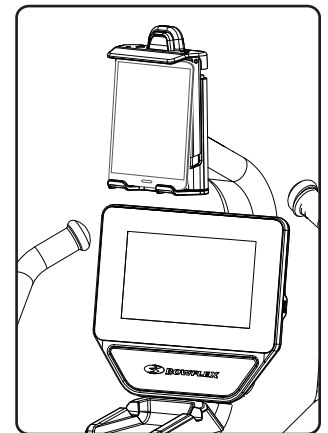

How Often Should You Exercise

 **Consult a physician before you start an exercise program. Stop exercising if you feel pain or tightness in your chest, become short of breath, or feel faint. Contact your doctor before you use the machine again. Use the values calculated or measured by the machine's computer for reference purposes only. The heart rate displayed on the console is an approximation and should be used for reference only.**

- 3 times a week for about 14 minutes each day.
- Schedule workouts in advance and try to follow the schedule.

Note: If you are new to exercise (or returning to a regular exercise program), and you are unable to comfortably complete 14 minutes of continuous exercise at one time, just do 5 – 10 minutes, and gradually increase your workout time until you can reach a 14 minute total.

Intensity of Workout

To increase the intensity of your workout:

- Push yourself to increase the number of Pedal revolutions per minute.
- Place your feet further out toward the rear of the Pedals.
- Increase the Intensity Level and keep your RPM consistent, or increase it as well.
- Use your upper and lower body at different levels.
- Shift your grip location on the Handlebars to work out other parts of your upper body.

Hand Placement (Grip Selection)

This fitness machine is equipped with multiple Handlebars which allow for a variety of different types of workouts. As you progress on your fitness routine, shift your hand placement to target different muscle groups.

 **Exercise on this machine requires coordination and balance. Be sure to anticipate that changes in speed and resistance level can occur during workouts, and be attentive in order to avoid loss of balance and possible injury.**

The Dynamic Handlebars allow for a variety of upper body workouts. When starting out, place your hands where it feels most comfortable and stable on the Dynamic Handlebars.

The Static Handlebars below the Console Assembly can also be used to add stability during a workout, as well as provide your heart rate. Use the Static Handlebars for a workout focused on legs. Be aware of the motion of the Dynamic Handlebars during the workout.

Mounting and Dismounting Your Machine

 **Care should be used when mounting or dismounting the machine.**

Be aware that the Pedals and the Handlebars are connected and when either of these parts move the other does as well. In order to avoid possible serious injury, grasp the Static Handlebars to steady yourself.

Be sure there is nothing under the Pedals or in the Air Resistance Fan before moving anything on the machine.

To mount your fitness machine:

1. Move the Pedals until the one nearest to you is in the lowest position.
2. Grasp the Static Handlebars under the Console Assembly.
3. Steadying yourself with the Static Handlebars, step up onto the lowest Pedal and place your other foot onto the opposite Pedal.

Note: "Bottomed out" is when the User is unable to start a workout because the Pedals will not move. If this occurs, safely grasp the Static Handlebars and apply your weight to the heel of the higher foot. While still grasping the Static Handlebar, lean back slightly applying more weight onto the heel. Once the Pedals begin to move, resume your intended workout.

To dismount your fitness machine:

1. Move the Pedal you want to dismount from to the highest position, and bring the machine to a complete stop.

 **This machine is not equipped with a free-wheel. Pedal speed should be reduced in a controlled manner.**

2. Grasp the Static Handlebars under the Console to steady yourself.
3. With your weight on the lowest foot, swing the upper foot off the machine and down onto the floor.
4. Step off of the machine and release your grip from the Static Handlebars.

Initial Console Set-Up

1. With the machine plugged into a functioning wall outlet, the machine will start up and the red Status LED will activate.
Note: The Console may go to sleep if it does not receive any input. Touch the screen of the Console to wake up the machine.
2. The machine will activate and display the Welcome - Connect Wifi screen. Tap on Connect.
Note: A Wifi connection is required to use your Bowflex™ machine. If you do not have a Wifi connection available, contact your Bowflex™ Representative or your local distributor immediately for further assistance.
3. The Console will display the list of available Wifi connections. Tap on the desired Wifi connection, and enter the password. Tap on Connect.
4. The Console will test and connect to the Wifi connection.
If the Console displays an Update Available screen, tap on the Agree button. The Console will update the software.
5. With a Wifi connection established, tap on Back.
6. Tap on Get Started.
7. The Console will display the options screen. Choose Log In or Create Account. Follow the prompts to register your new fitness machine. When registration is completed, your fitness machine is now ready for use.
Note: The Bowflex™ machine must be registered using a Wifi connection. Once the initial registration and configuration is completed, the machine can be operated without a Wifi connection. However, only the basic workouts and functions will be available for use. All coaching*, custom workouts*, Explore The World™ virtual outdoor immersive runs and trainer lead workout videos* are only available through a Wifi connection with a JRNY™ membership*.
8. The Console will display the Just for You screen. The screen will prompt you to do your Fitness Assessment workout to get a custom workout*. You can go to the Learn tab for more information about your options.

Getting Started

1. Place the fitness machine in your workout area.

! Place the machine on a clean, hard, level surface, free from unwanted material or other objects that may hamper your ability to move freely. A rubber mat can be used below the machine to prevent the release of static electricity and protect your flooring.

The machine can be moved by one or more persons. Make sure that your own physical strength is capable of safely moving the machine.

2. Examine for any objects below the Pedals and in the Air Resistance Fan. Be sure it is clear.
3. Connect the power cord to the machine and into a grounded AC Wall Outlet.
Note: If the Console does not turn on after connecting the power, the Console may need to be charged to be able to activate. Charge the Console until it is able to activate.
4. If you use a Heart Rate Monitor, follow the Heart Rate Monitor directions.
5. To mount the machine, move the Pedals until the one nearest you is in the lowest position.

! Care should be used when mounting or dismounting the machine.

Be aware that the Pedals and the Handlebars are connected and when either of these parts move the other does as well. In order to avoid possible serious injury, grasp the Static Handlebars to steady yourself.

6. Grasp the Static Handlebars.
7. Steadying yourself with the Static Handlebars, step up onto the lowest Pedal and place your other foot onto the opposite Pedal.
Note: "Bottomed out" is when the User is unable to start a workout because the Pedals will not move. If this occurs, safely grasp the Static Handlebars and apply your weight to the heel of the higher foot. While still grasping the Static Handlebar, lean back slightly applying more weight onto the heel. Once the Pedals begin to move, resume your intended workout.
8. You are now in position to begin a workout.
Note: When operating the Bowflex™ Max Trainer™ machine, be sure the Legs are moving in the direction as shown on the Crank Cover.

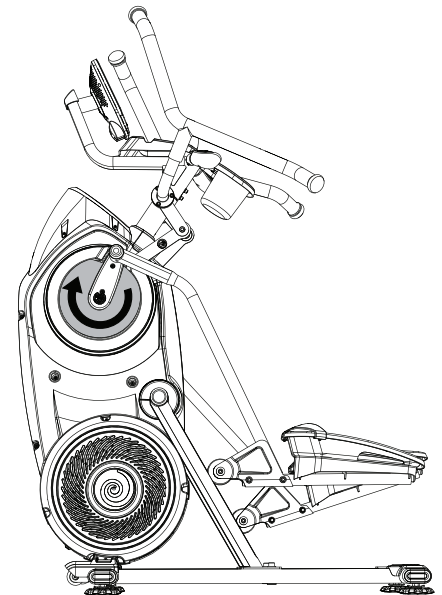

Power Up Mode / Just For You Tab

The Console will enter Power-Up mode / Just For You tab if it is plugged into a power source, the Console display is touched, or if it receives a signal from the RPM sensor as a result of pedaling the machine.

Auto Shut-Off (Sleep Mode)

If the Console does not receive any input in approximately 5 minutes, it will automatically shut off. The display is off while in Sleep Mode.

* A JRNY™ membership is required for the JRNY™ experience – see www.bowflex.com/jrny for details. For United States and Canada customers, you can obtain a JRNY™ membership by calling 800-269-4126 or visiting www.bowflex.com/jrny. Where available (including the United States), you can also obtain a JRNY™ membership by downloading the JRNY™ app onto your phone or tablet and signing up within the downloaded app. JRNY™ memberships may not be available in all countries.

Pausing or Stopping a Workout

1. To Pause a workout, stop pedaling during the workout

Note: The Console will automatically pause if there is no RPM signal for 5 seconds, or if you tap the screen and tap the Pause button. When paused, the Console will display the Play and Stop buttons.

2. To continue the workout, begin pedaling or tap the Play button.
To end the workout before completing it, tap Stop.
3. After the workout, the Console will display the Workout Complete values (Total Time, Total Intervals, Total Calories, Average Sprint Burn Rate, Average Heart Rate, Average RPM, and Average Resistance).
4. Tap Continue.
5. The Console will go to the Overview of the Latest Workout of the JOURNAL tab.

Power Off and Restart the Machine

Note: When active, the Bowflex™ machine checks for software updates and installs them. If the machine is de-activated for a period of time, it may try to install updates when restarted.

1. To power off the machine, log the user out from the Console.
2. Unplug the power cord from the machine.

 **To prevent unsupervised operation of the machine always disconnect the power cord from the wall outlet and machine power input. Place the power cord in a secure location.**

To restart the machine:

1. Plug in the machine to a functioning wall outlet. The machine will start up, and the red Status LED will activate.

Read all maintenance instructions fully before you start any repair work. In some conditions, an assistant is required to do the necessary tasks.

 **Equipment must be regularly examined for damage and repairs. The owner is responsible to make sure that regular maintenance is done. Worn or damaged components must be repaired or replaced immediately. Only manufacturer supplied components can be used to maintain and repair the equipment.**

If at any time the Warning labels become loose, unreadable or dislodged, replace the labels. If purchased in US/Canada, contact Customer Service for replacement labels. If purchased outside US/Canada, contact your local distributor for them.

To reduce the risk of electrical shock or usage of the equipment, always unplug the power cord from the wall outlet and the machine and wait 5 minutes before cleaning, maintaining or repairing the machine. Place the power cord in a secure location.

Daily: Before each use, examine the exercise machine for loose, broken, damaged, or worn parts. Do not use if found in this condition. Repair or replace all parts at the first sign of wear or damage. After each workout, use a damp cloth to wipe your machine and Console free of sweat.

Note: Avoid excessive moisture on the Console.

Weekly: Check for smooth roller operation. Wipe the machine to remove dust, dirt, or grime. Clean the rails and surface of the rollers with a damp cloth.

Apply silicone lubricant to a dry cloth and wipe the rails to eliminate roller noise.

 **Silicone lubricant is not intended for human consumption. Keep out of reach of children. Store in a safe place.**

Note: Do not use petroleum based products.

Monthly or after 20 hours: Make sure all bolts and screws are tight. Tighten as necessary.

NOTICE: If necessary, only use a mild dish soap with a soft cloth to clean the Console. Do not clean with a petroleum based solvent, automotive cleaner, or any product that contains ammonia. Do not clean the Console in direct sunlight or at high temperatures. Be sure to keep the Console free of moisture.

Buy Back Guarantee *(if purchased in US/Canada)*

We want you to know that your Bowflex™ Max Trainer™ machine is a superior product. Your satisfaction is guaranteed. If, for any reason, you are not 100% satisfied with your Bowflex™ Max Trainer™ machine, please follow the instructions below to return your merchandise and receive a refund of the purchase price, less shipping and handling.

This Bowflex™ Max Trainer™ Buy Back Guarantee applies only to merchandise purchased by consumers directly from Nautilus, Inc. This guarantee does not apply to sales made by dealers, retailers, or distributors.

1. Call a Bowflex™ Max Trainer™ Representative at 1-800-605-3369 for a Return Authorization Number (RMA). An RMA will be granted if:
 - a. The Bowflex™ Max Trainer™ exercise machine was purchased directly from Nautilus, Inc.
 - b. The request to return the product is within 6 weeks of the delivery date of your merchandise.

2. If an RMA is granted, the following instructions will prevent delays in the processing of your refund.
 - a. The merchandise must be returned to the address given to you at the time of the Return Authorization Call.
 - b. All returned merchandise must be properly packaged in good condition, preferably in the original boxes.
 - c. The exterior of the boxes should be marked clearly with:
 - Return Authorization Number
 - Your Name
 - Your Address
 - Your Phone Number
 - d. Additionally, a piece of paper with your name, address and phone number or copies of your original invoice should be placed in each box of merchandise.
 - e. Your RMA number is time sensitive. Your shipment must be post marked within two weeks from the date the Bowflex™ Max Trainer™ Representative issued the Return Authorization Number.

Note: You are responsible for return shipping and for any damage or loss to merchandise that occur during return shipment. Nautilus recommends that you obtain tracking numbers and insure your shipment.

Unauthorized Returns

Nautilus, Inc. defines an unauthorized return as any merchandise returned to our facilities without a valid and current Return Merchandise Authorization (RMA) number issued by Nautilus. Failure to properly mark packages with a valid RMA number, or allowing an RMA number to expire, will cause Nautilus, Inc. to consider a return unauthorized. Any merchandise returned without a RMA number will not be subject to a refund or credit and Nautilus will discard the product. The customer assumes all shipping and handling charges for any unauthorized return.

Who Is Covered

This warranty is valid only to the original purchaser and is not transferable or applicable to any other person(s).

What Is Covered

Nautilus, Inc. warrants that this product is free from defects in materials and workmanship, when used for the purpose intended, under normal conditions, and provided it receives proper care and maintenance as described in the Product's Assembly and Owner's manual. This warranty is good only for authentic, original, legitimate machines manufactured by Nautilus, Inc. and sold through an authorized agent and used in the United States or Canada.

Terms

Warranty terms for products purchased in US/Canada are as stated below.

- Frame 3 years
- Mechanical parts 3 years
- Electronics 1 year
- Labor 90 days

(Labor support does not include the installation of replacement parts involved in the initial product assembly and preventative maintenance services. All repairs covered under the labor portion of the warranty must be preauthorized by Nautilus. The customer will be responsible for a minimal trip charge.)

For warranty & service of products purchased outside US/Canada, please contact your local distributor. To find your local international distributor, go to: www.nautilusinternational.com

How Nautilus Will Support the Warranty

Throughout the terms of the warranty coverage, Nautilus, Inc. will repair any machine that proves to be defective in materials or workmanship. Nautilus reserves the right to replace the product in the event a repair is not possible. When Nautilus determines replacement is the correct remedy, Nautilus may apply a limited credit reimbursement toward another Nautilus, Inc. brand Product, at our discretion. This reimbursement may be prorated based on length of ownership. Nautilus, Inc. provides repair service within major metropolitan areas. Nautilus, Inc. reserves the right to charge the consumer for travel outside these areas. Nautilus, Inc. is not responsible for dealer labor or maintenance charges beyond the applicable warranty period(s) stated herein. Nautilus, Inc. reserves the right to substitute material, parts or products of equal or better quality if identical materials or products are not available at the time of service under this warranty. Any replacement of the product under the terms of the Warranty in no way extends the original Warranty period. Any limited credit reimbursement may be prorated based on length of ownership. **THESE REMEDIES ARE THE EXCLUSIVE AND SOLE REMEDIES FOR ANY BREACH OF WARRANTY.**

What You Must Do

- Retain appropriate and acceptable Proof of Purchase.
- Operate, maintain, and inspect the Product as specified in the Product Documentation (Assembly, Owner's Manuals, etc.).
- Product must be used exclusively for the purpose intended.
- Notify Nautilus within 30 days after detecting an issue with the Product.
- Install replacement parts or components in accordance with any Nautilus instructions.
- Perform diagnostic procedures with a trained Nautilus, Inc representative if requested.

What Is Not Covered

- Damage due to abuse, tampering or modification of the Product, failure to properly follow assembly instructions, maintenance instructions, or safety warnings as stated in the Product Documentation (Assembly, Owner's Manuals, etc), damage due to improper storage or the effect of environmental conditions such as moisture or weather, misuse, mishandling, accident, natural disasters, power surges.
- A machine placed or used in a commercial or institutional setting. This includes gyms, corporations, work places, clubs, fitness centers and any public or private entity that has a machine for use by its members, customers, employees or affiliates.
- Damage caused by exceeding maximum user weights as defined in the Product's Owner's manual or warning label.
- Damage due to normal usage and wear and tear.
- This warranty does not extend to any territories or countries outside the United States and Canada.

How to Obtain Service

For Products purchased directly from Nautilus, Inc. contact the Nautilus office listed on the Contacts page of the products Owner's manual. You may be required to return the defective component to a specified address for repair or inspection, at your expense. Standard ground shipping of any warranty replacement parts will be paid by Nautilus, Inc. For products purchased from a retailer, you may be asked to contact your retailer for warranty support.

Exclusions

The preceding warranties are the sole and exclusive express warranties made by Nautilus, Inc. They supersede any prior, contrary or additional representations, whether oral or written. No agent, representative, dealer, person or employee has the authority to alter or increase the obligations or limitations of this warranty. Any implied warranties, including the WARRANTY OF MERCHANTABILITY and any WARRANTY OF FITNESS FOR A PARTICULAR PURPOSE, are limited in duration to the term of the applicable express warranty provided above, whichever is longer. Some states do not allow limitations on how long an implied warranty lasts, so the above limitation may not apply to you.

Limitation of Remedies

EXCEPT AS OTHERWISE REQUIRED BY APPLICABLE LAW, THE PURCHASER'S EXCLUSIVE REMEDY IS LIMITED TO REPAIR OR REPLACEMENT OF ANY COMPONENT DEEMED BY NAUTILUS, INC. TO BE DEFECTIVE UNDER THE TERMS AND CONDITIONS STATED HEREIN. IN NO EVENT WILL NAUTILUS, INC. BE LIABLE FOR ANY SPECIAL, CONSEQUENTIAL, INCIDENTAL, INDIRECT OR ECONOMIC DAMAGES, REGARDLESS OF THE THEORY OF LIABILITY (INCLUDING, WITHOUT LIMITATION, PRODUCT LIABILITY, NEGLIGENCE OR OTHER TORT) OR FOR ANY LOST REVENUE, PROFIT, DATA, PRIVACY OR FOR ANY PUNITIVE DAMAGES ARISING OUT OF OR RELATED TO THE USE OF THE FITNESS MACHINE EVEN IF NAUTILUS, INC. HAS BEEN ADVISED OF THE POSSIBILITY OF SUCH DAMAGES. THIS EXCLUSION AND LIMITATION SHALL APPLY EVEN IF ANY REMEDY FAILS OF ITS ESSENTIAL PURPOSE. SOME STATES DO NOT ALLOW THE EXCLUSION OR LIMITATION OF CONSEQUENTIAL OR INCIDENTAL TYPE DAMAGES SO THE ABOVE LIMITATION MAY NOT APPLY TO YOU.

State Laws

This warranty gives you specific legal rights. You may also have other rights, which vary from state to state.

Expirations

If the warranty has expired, Nautilus, Inc. may assist with replacements or repairs to parts and labor, but there will be a charge for these services. Contact a Nautilus office for information on post-warranty parts and services. Nautilus does not guarantee availability of spare parts after expiration of warranty period.

International Purchases

If you purchased your machine outside of the United States consult your local distributor or dealer for warranty coverage.



Nautilus, Inc., 5415 Centerpoint Parkway, Groveport, OH 43125 USA, www.NautilusInc.com - Customer Service: North America (800) 605-3369, csnls@nautilus.com | Nautilus (Shanghai) Fitness Equipments Co, Ltd, Room 1701 &1702, 1018 Changning Road, Changning District, Shanghai, China 200042, www.nautilus.cn - 86 21 6115 9668 | outside U.S. www.nautilusinternational.com | Printed in China | © 2020 Nautilus, Inc. | Bowflex, the Bowflex logo, Max Trainer, and JRNY are trademarks owned or licensed by Nautilus, Inc., registered or otherwise protected by common law in the U.S. and other countries. The Bluetooth® word mark and logos are registered trademarks owned by Bluetooth SIG, Inc., and any use of such marks by Nautilus, Inc. is under license. Other trademarks are the property of their respective owners.

8025955.011521.B

ORIGINAL MANUAL - ENGLISH VERSION ONLY

